

玉ネギは、何個あるかな？

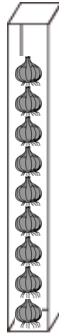

Bien!

9個ね！



玉ネギは、何個あるかな？

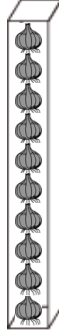

Bien!

10個だ！



ここに、もう1個玉ネギを入れると、全部で何個になる？

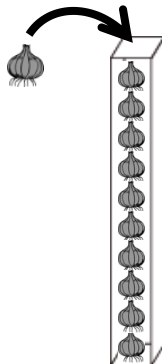

箱がいっぱいで、もう、入らないよ。

10より
大きい数は
知らない！



では、この図を使って、10より大きい数の表し方を調べてみよう。

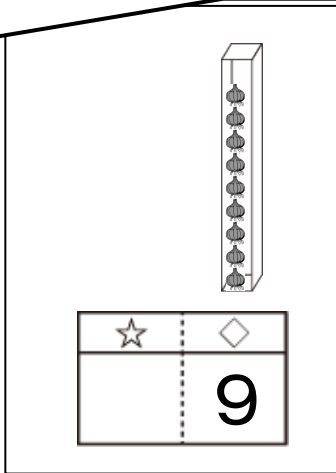

玉ネギが9個のときは、
下の箱の \diamond のところ
に、「9」と書くのね。



上の箱に1個入れると、どうなるかな？

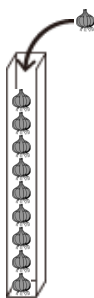

9個に1個入れる。

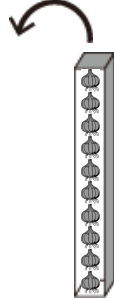

右側の箱がいっぱい
になるので、左側に
移す。

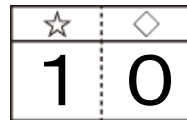
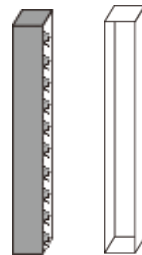

左側に、玉ネギ10個入
りの箱が1箱あるから、
 \star のところに「1」、
 \diamond のところに「0」
と書く。



では、ここに1個入れると、どうなるかな？

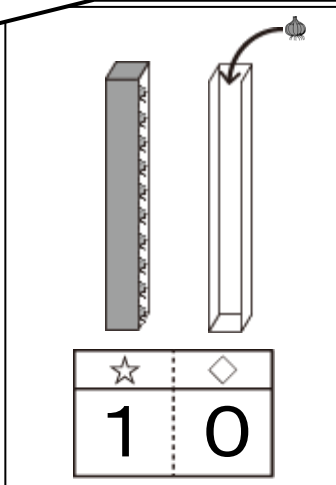

◇が「0」のところに、1個入れるんだね。10より大きくなるね。

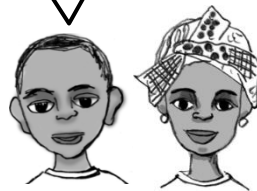

10より1大きい数は「11」と書くよ。

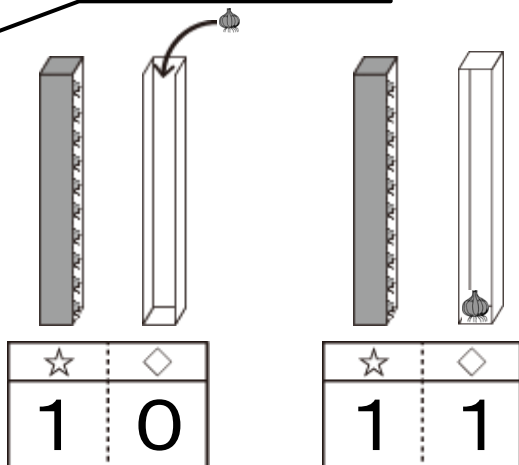

10個より1個多いのは、11個なのね。



10個に1個入れる。

右側の箱に、玉ネギ1個が入ったから、

☆のところに「1」、
○のところに「1」と書く。

例題 玉ねぎの数はいくつでしょう。

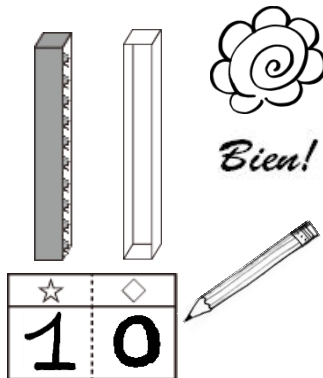
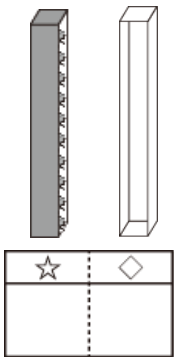

問題 玉ネギの数はいくつでしょう。

①

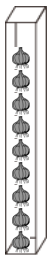

②

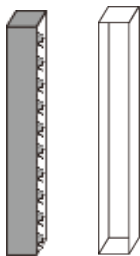

③

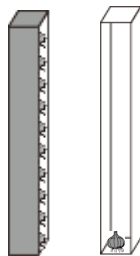

④

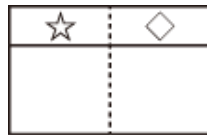
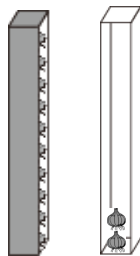

⑤

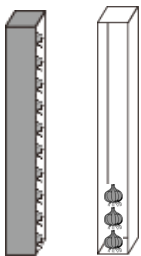

⑥

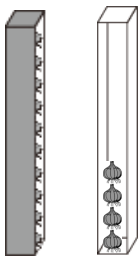

⑦

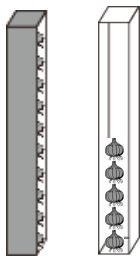

⑧

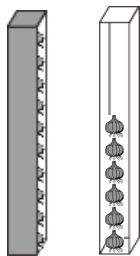

問題 玉ネギの数はいくつでしょう。

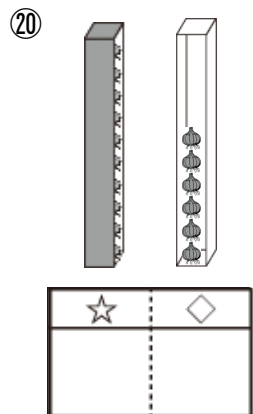
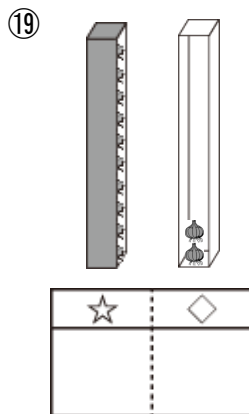
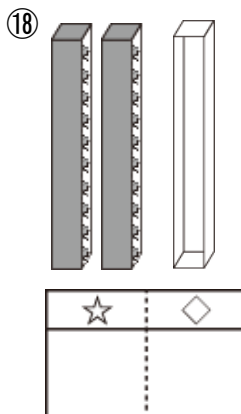
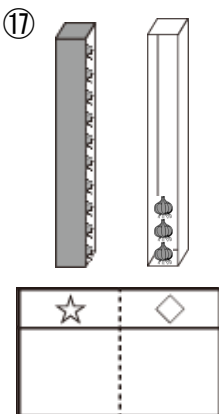
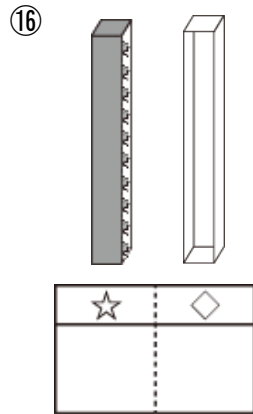
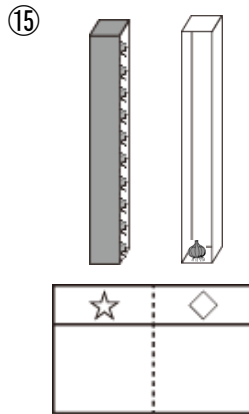
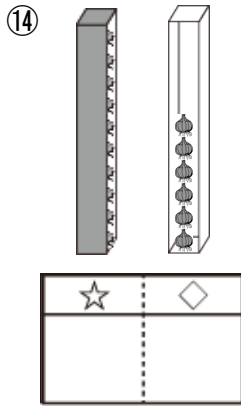
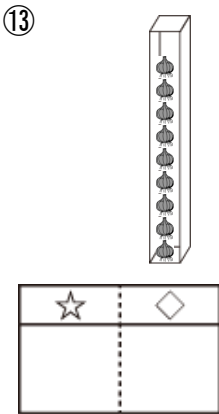
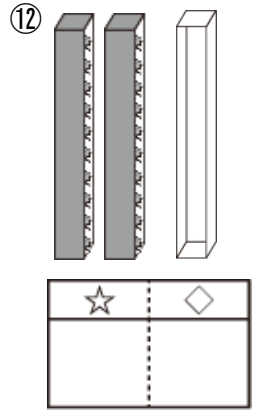
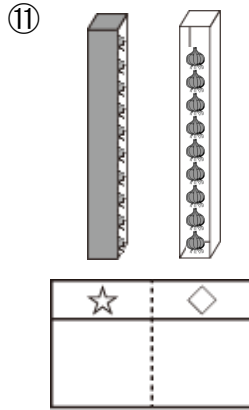
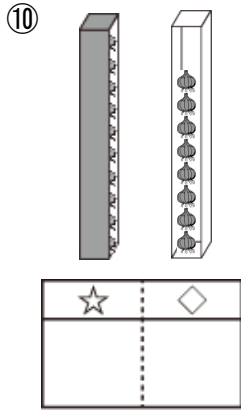
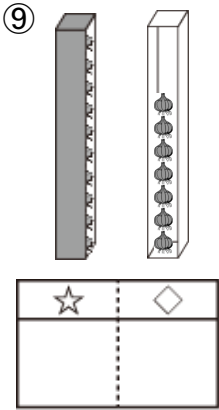

例題 玉ねぎの数はいくつでしょう。

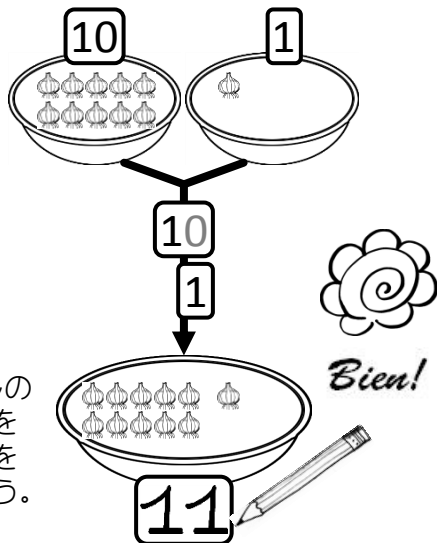
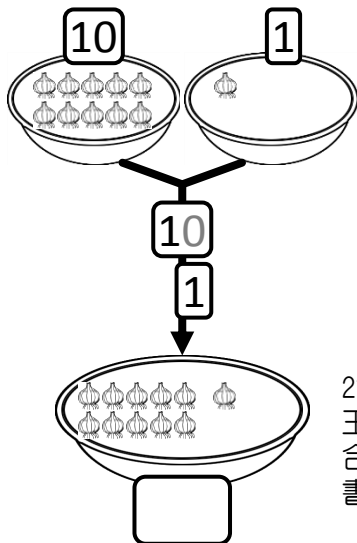

2つのボウルの
玉ねぎの数を
合わせた数を
書きましょう。

問題 玉ねぎの数はいくつでしょう。

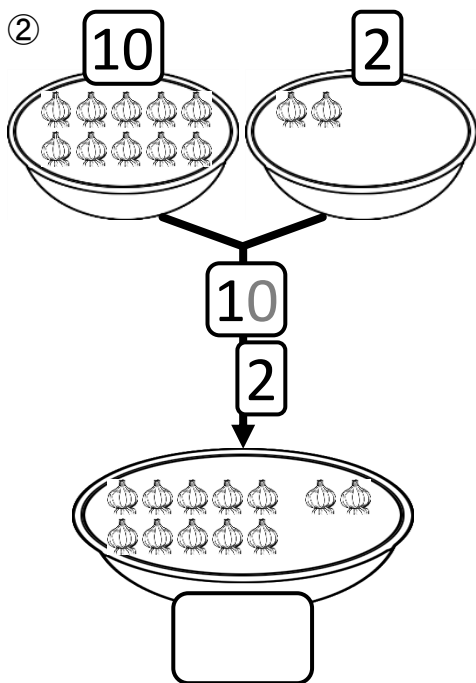
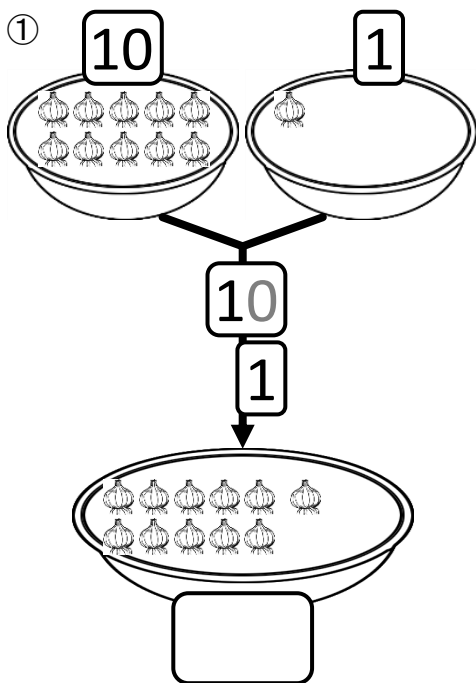

問題 玉ネギの数はいくつでしょう。

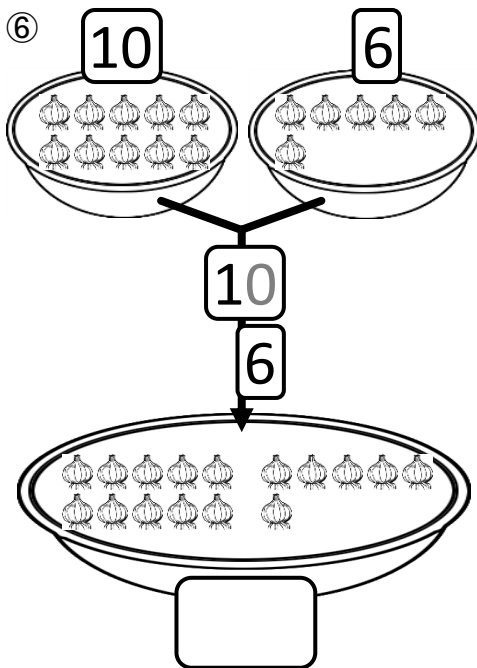
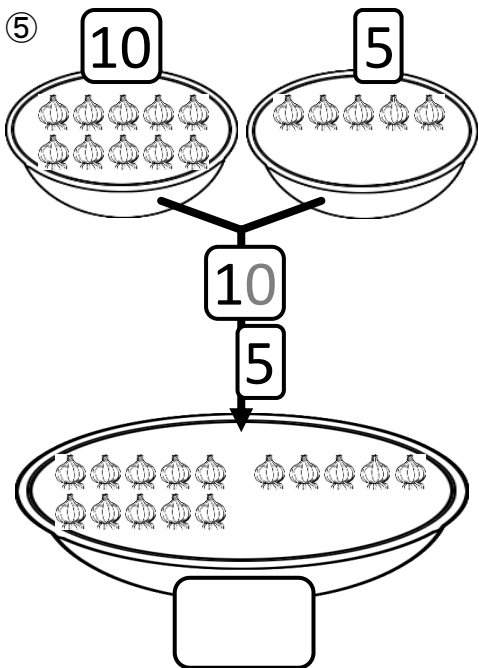
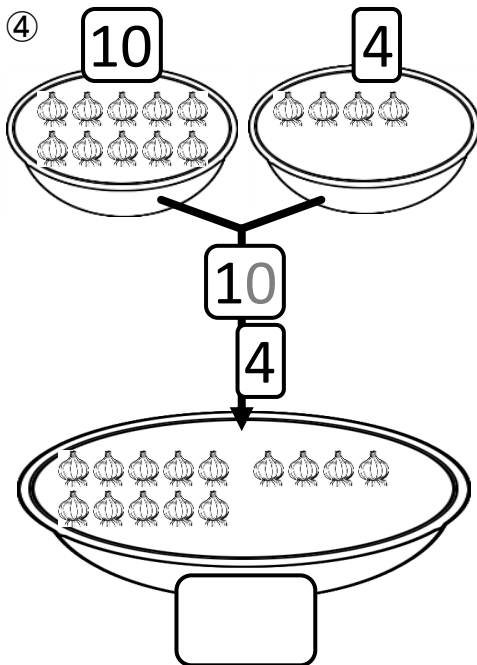
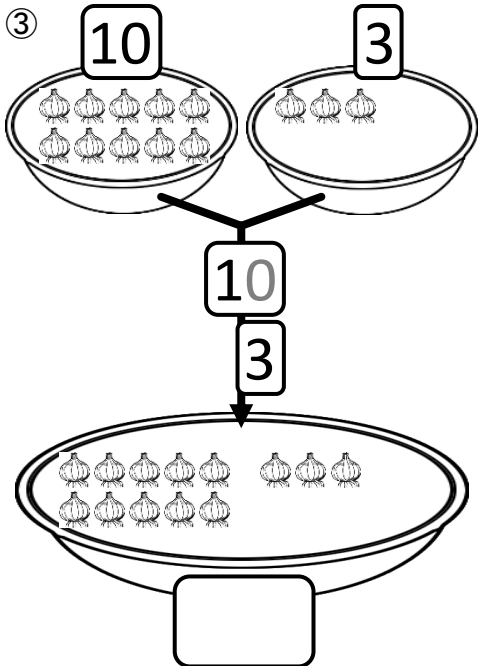

問題 玉ネギの数はいくつでしょう。

⑦

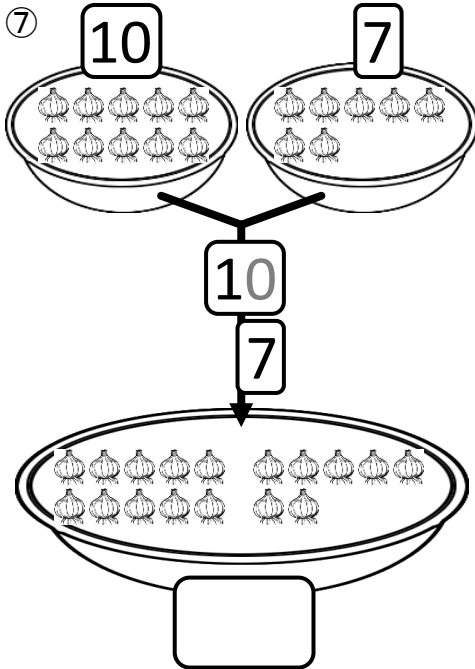

⑧

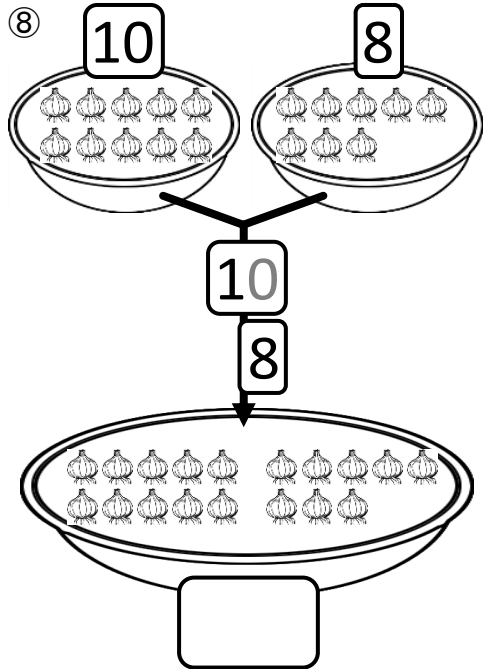

⑨

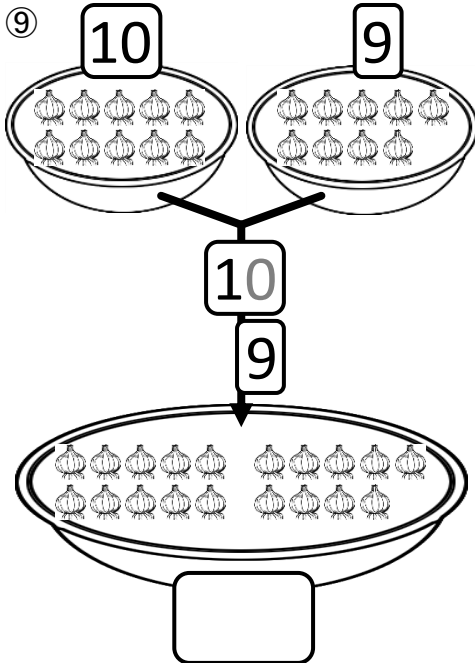

⑩

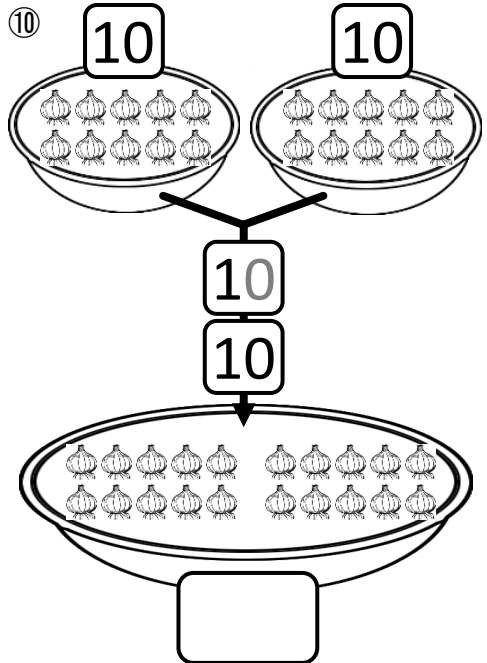

問題 玉ネギの数はいくつでしょう。

