

مثال  دعونا نكتب العدد المُنتطبق داخل

يا ترى ٥ يُمكن تقسيمه إلى ٣ وماذا؟

السؤال  دعونا نكتب العدد المُنتطبق داخل

(٣)

(٢)

(١)

(٦)

(٥)

(٤)

السؤال دعونا نكتب العدد المُنتطبق داخل

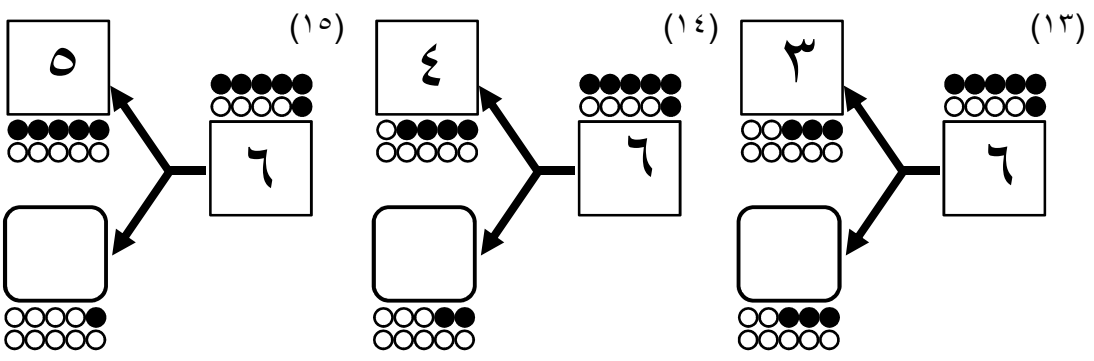
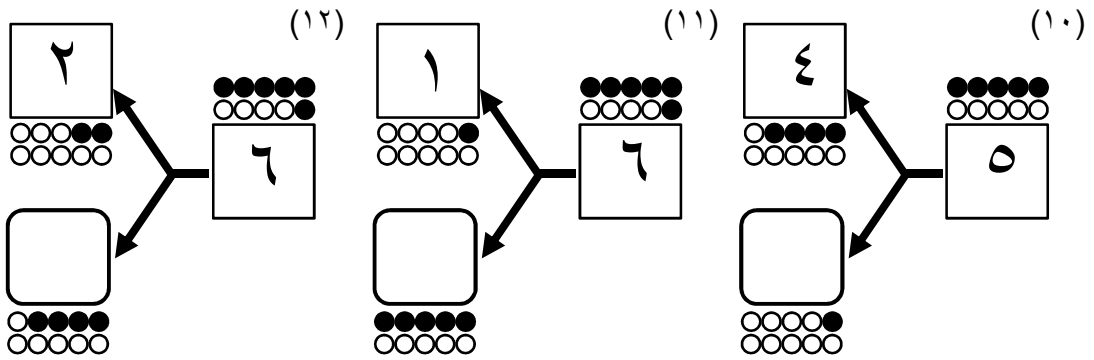
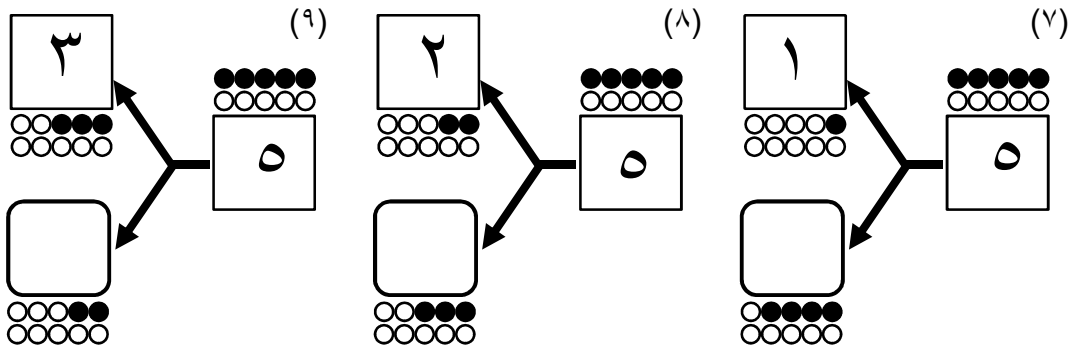

السؤال دعونا نكتب العدد المُنتطبق داخل

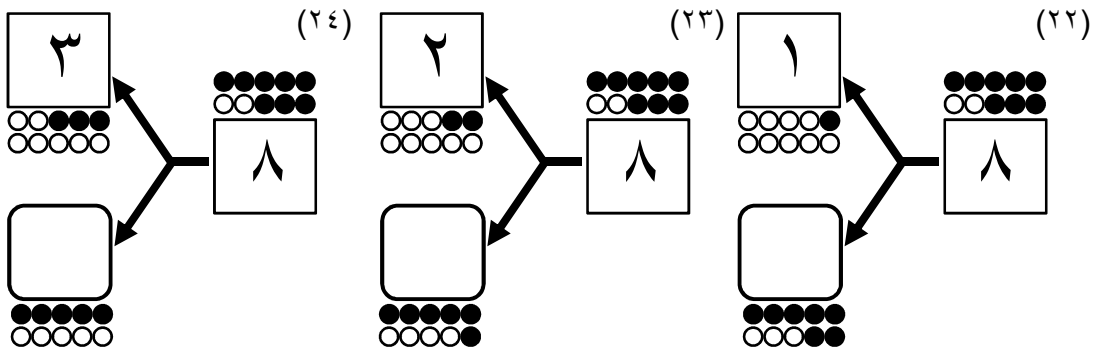
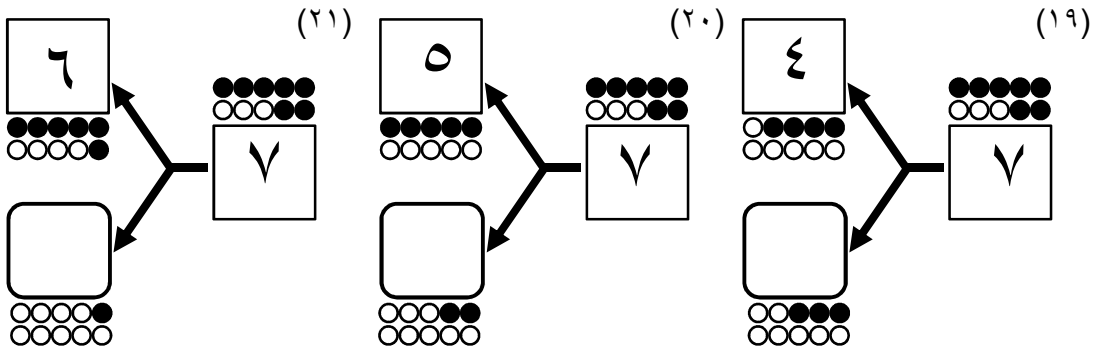
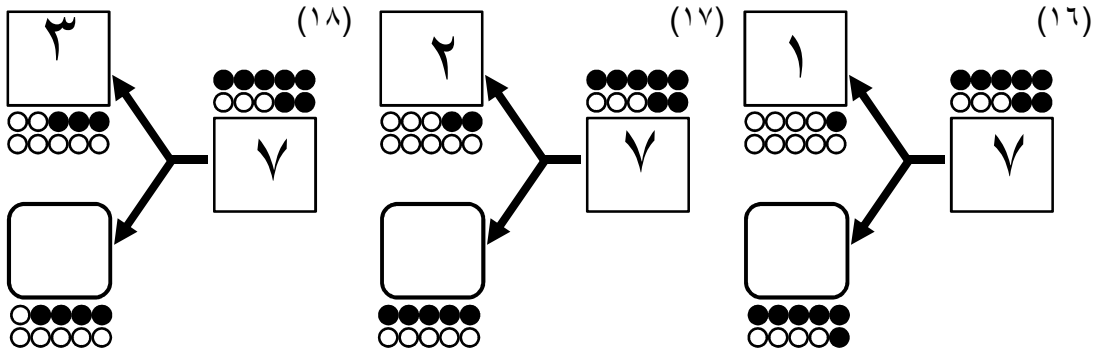

السؤال دعونا نكتب العدد المنطيق داخل

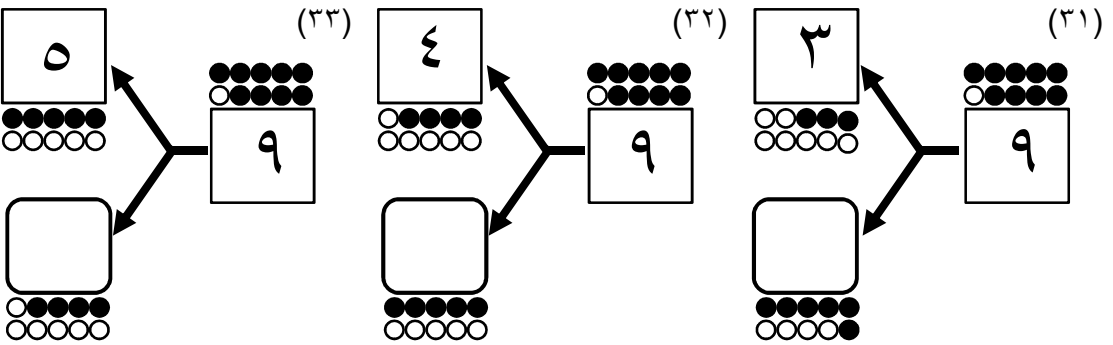
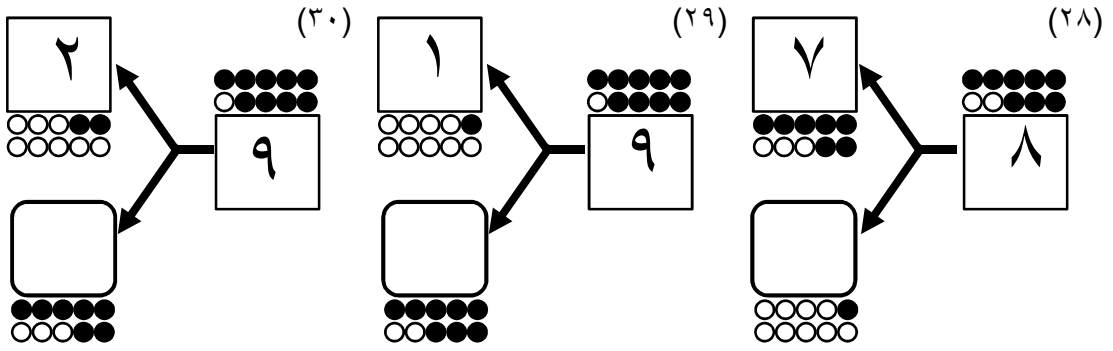
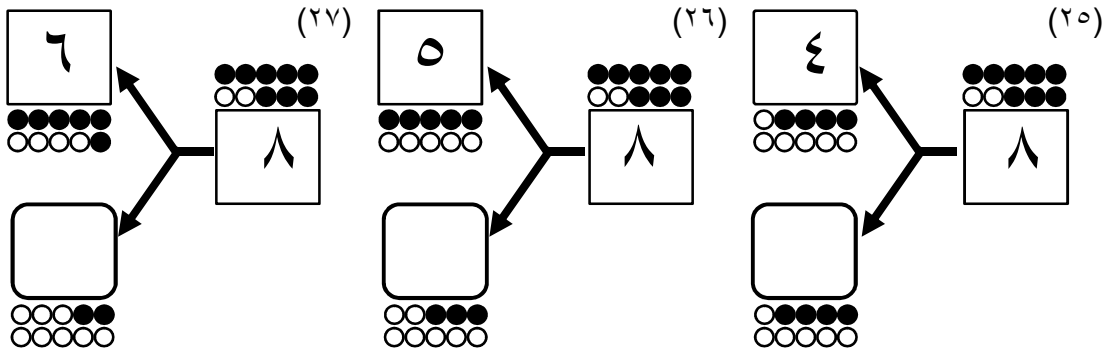

السؤال دعونا نكتب العدد المُنطبق داخل

(٣٦)

(٣٥)

(٣٤)

(٣٩)

(٣٨)

(٣٧)

(٤٢)

(٤١)

(٤٠)

السؤال دعونا نكتب العدد المُنتَبق داخل

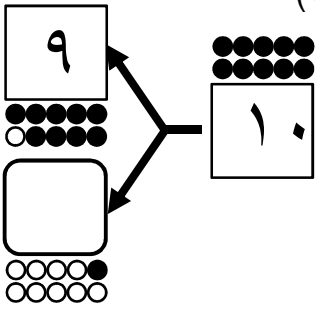
(٤٥) 

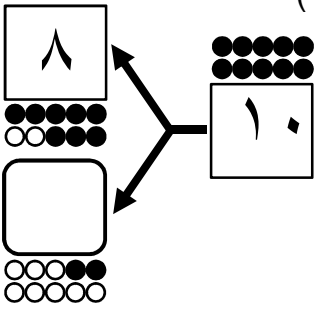
(٤٤) 

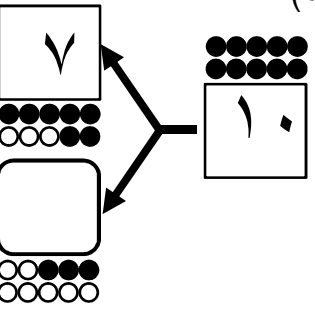
(٤٣) 

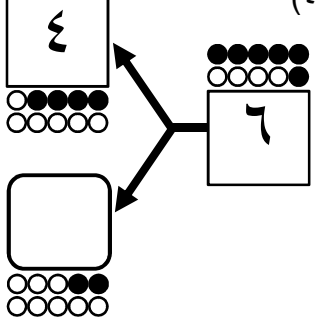
(٤٨) 

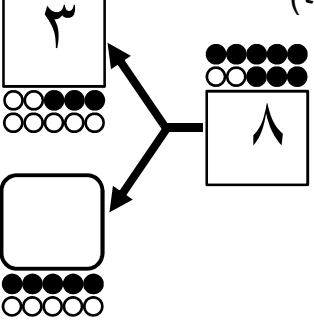
(٤٧) 

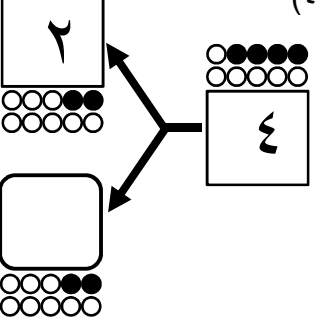
(٤٦) 

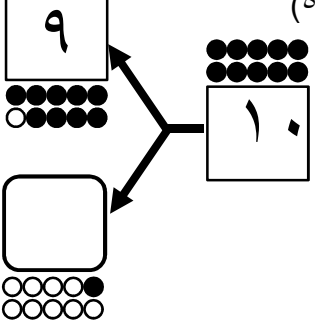
(٥١) 

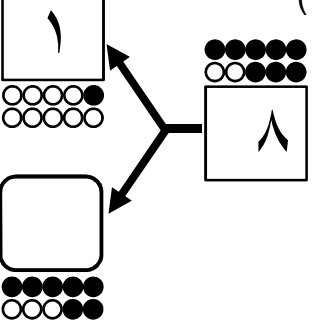
(٥٠) 

(٤٩) 