

例題

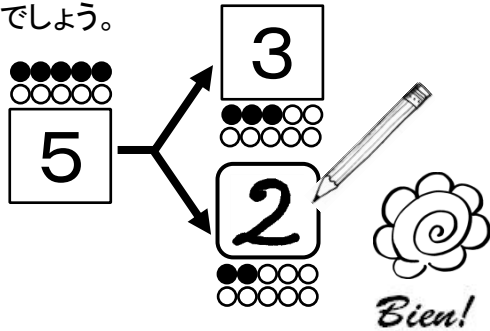

にあてはまる数を書きましょう。

5は3といくつに分けられるでしょう。

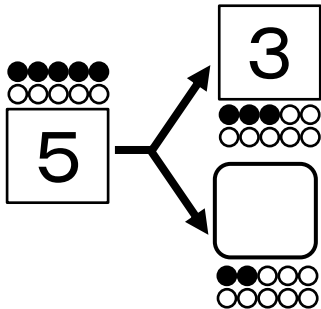

問題



にあてはまる数を書きましょう。

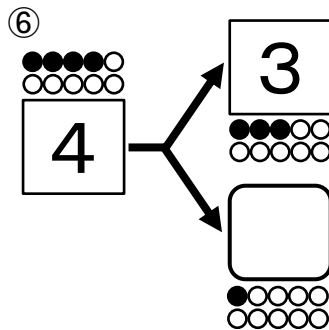
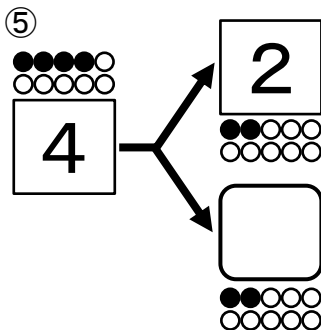
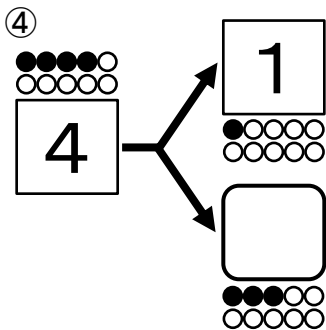
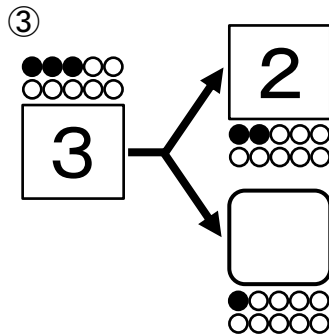
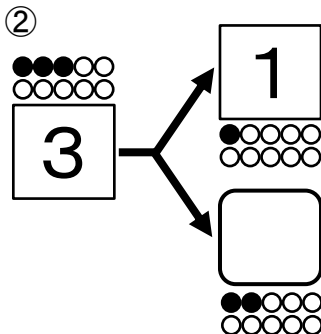
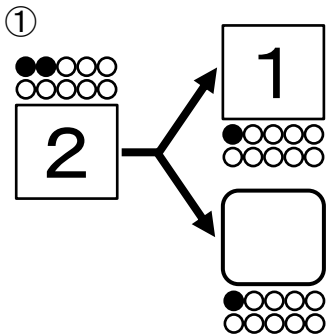

問題

□にあてはまる数を書きましょう。

⑦

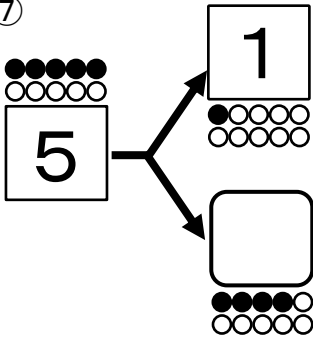

⑧

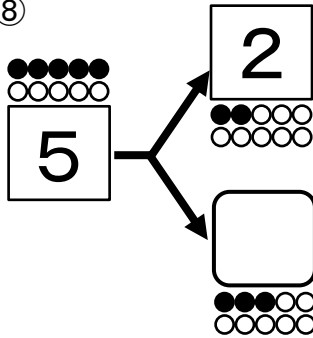

⑨

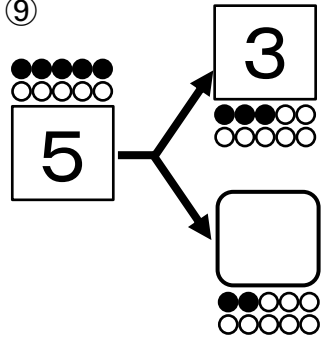

⑩

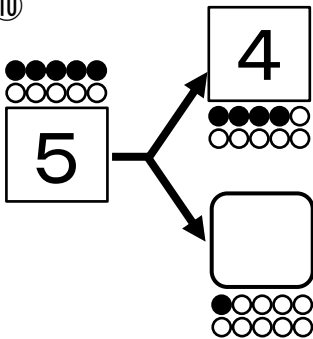

⑪

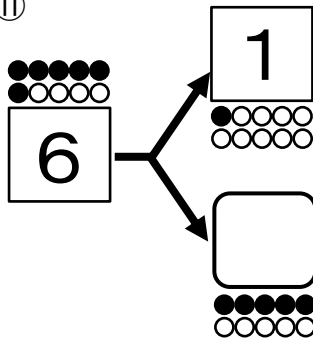

⑫

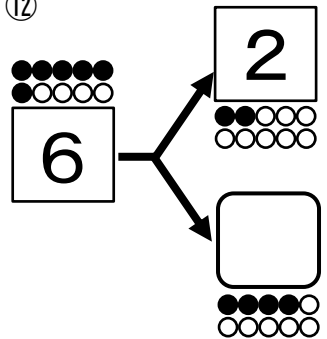

⑬

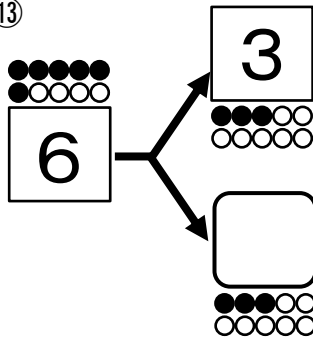

⑭

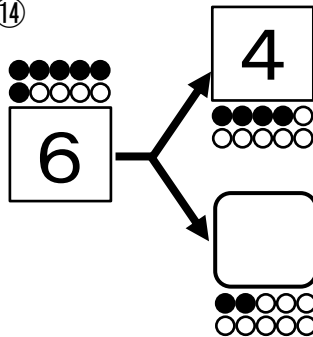

⑮

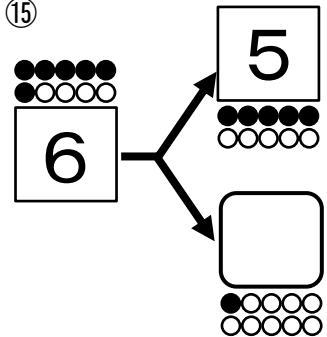

問題

□にあてはまる数を書きましょう。

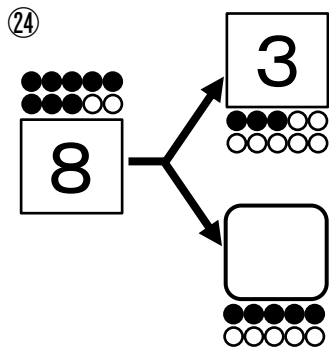
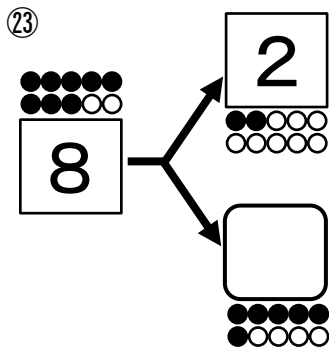
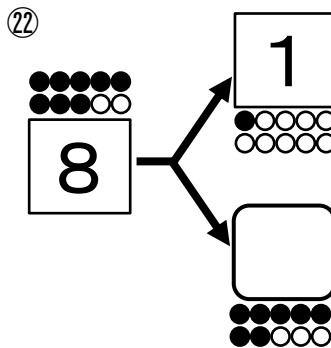
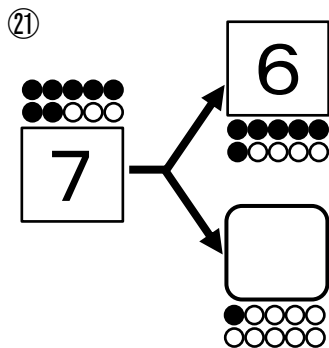
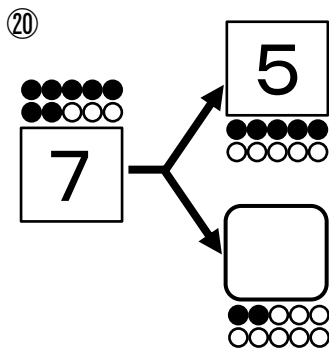
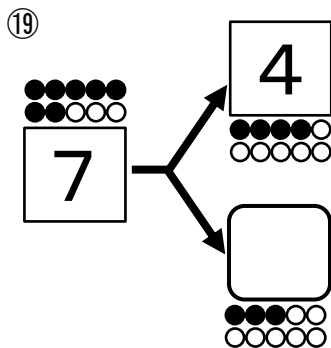
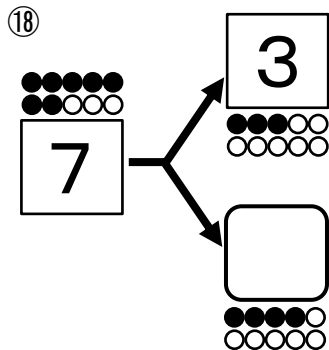
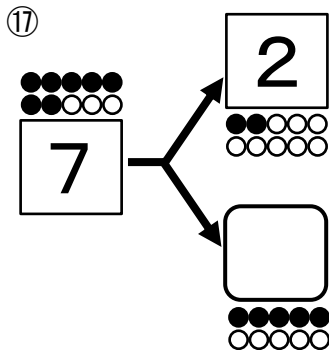
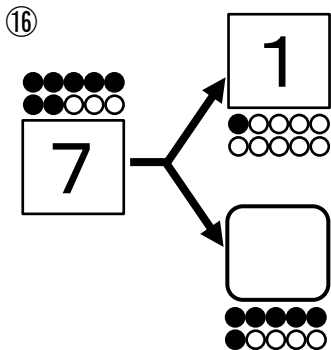

問題

□にあてはまる数を書きましょう。

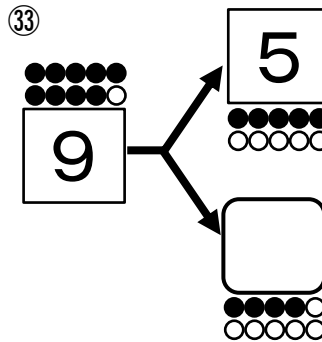
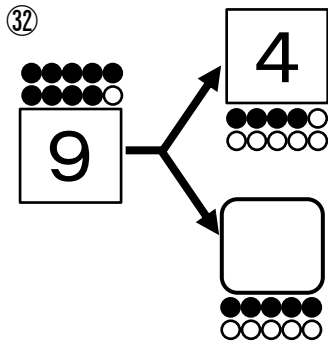
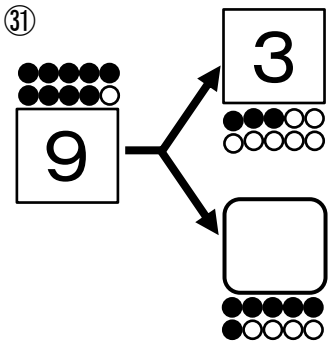
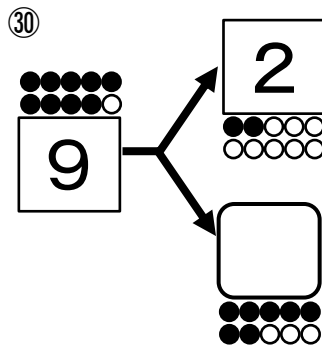
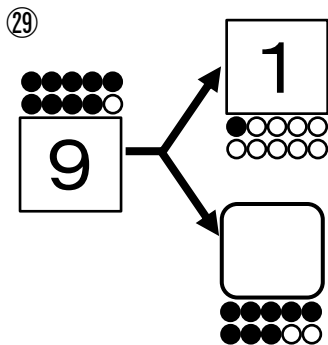
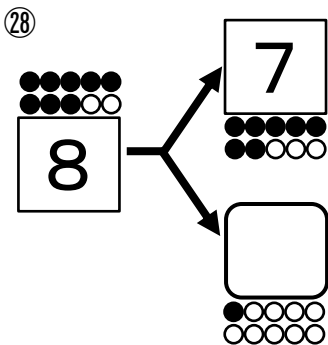
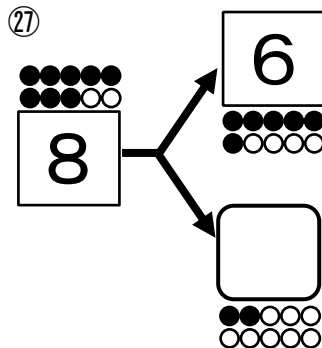
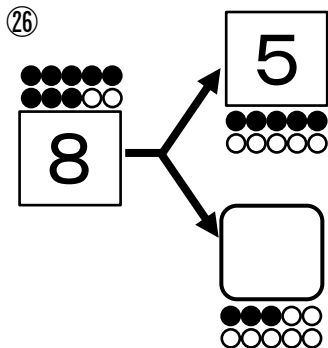
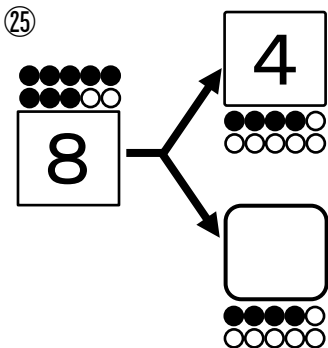

問題

□にあてはまる数を書きましょう。

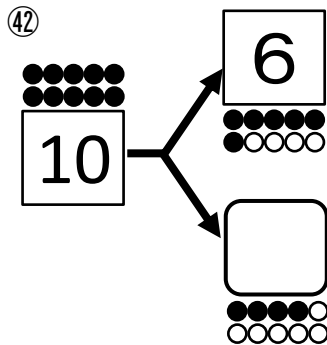
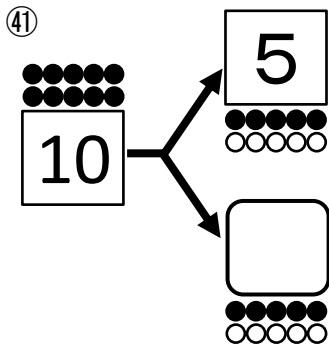
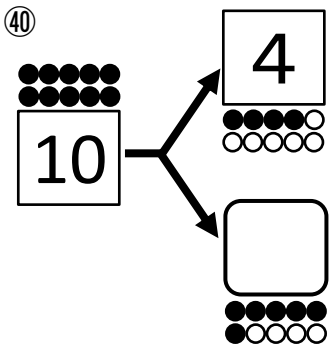
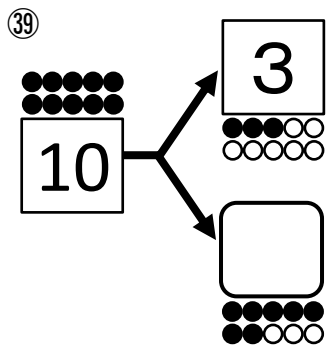
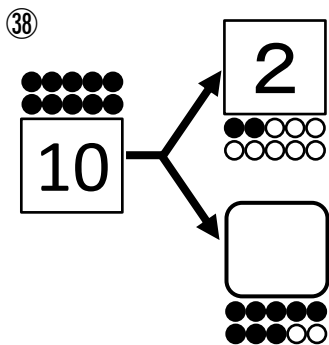
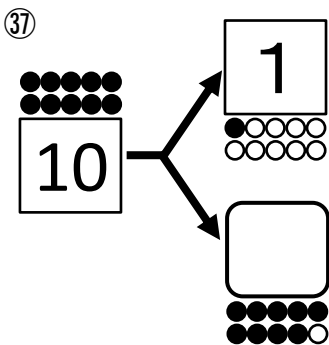
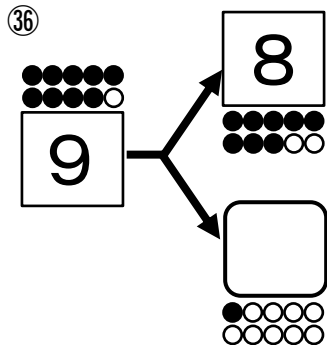
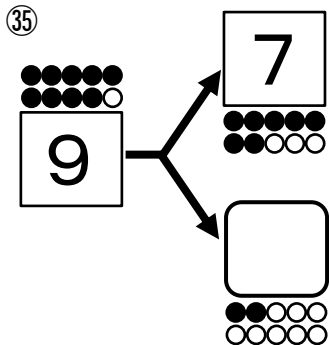
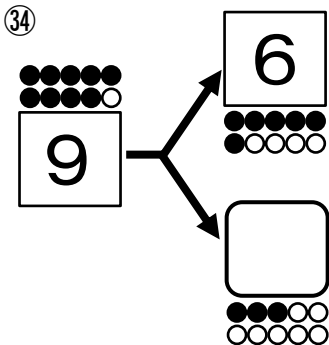

問題

□にあてはまる数を書きましょう。

43

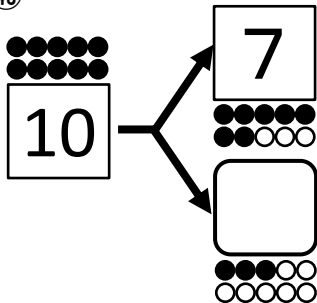

44

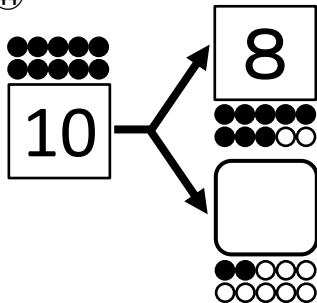

45

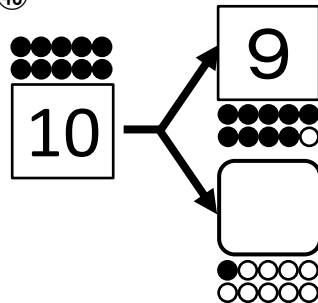

46

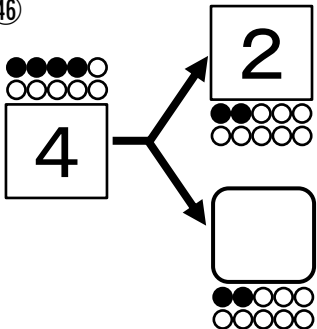

47

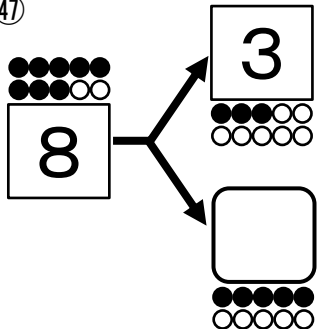

48

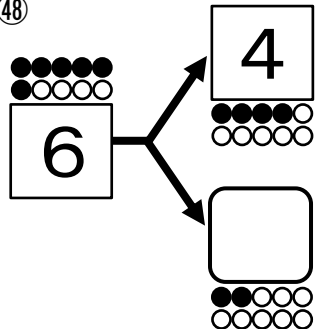

49

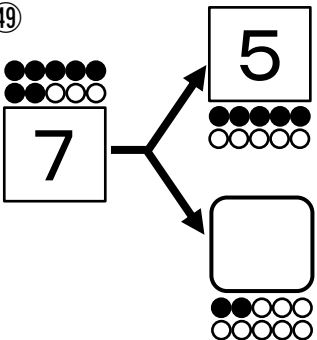

50

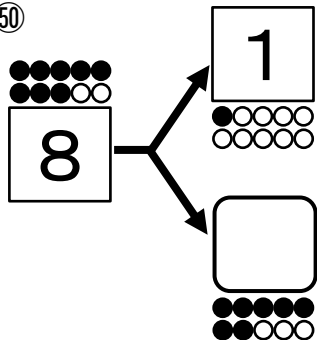

51

