

$$\begin{array}{cccccccc}
 + & = & 2 & 4 & - & 6 & \div & 8 & + & 0 & = \\
 1 & & & & & & & & & & \\
 3 & & + & 5 & \div & 7 & - & 9 & = & & 
 \end{array}$$

# Mathematics

## Teacher's Manual



# Grade 5



Papua New Guinea  
Department of Education

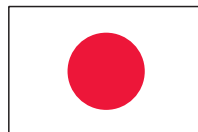

From  
the People of Japan

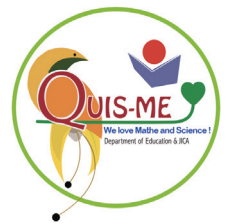

'FREE ISSUE  
NOT FOR SALE'

## **Issued free to schools by the Department of Education**

First Edition

Published in 2020 by the Department of Education, Papua New Guinea.

© Copyright 2020, Department of Education, Papua New Guinea.

All rights reserved. No part of this publication may be reproduced, stored in a retrieval system or transmitted by any form or by any means of electronic, mechanical, photocopying, recording or otherwise without the prior written permission of the publisher.

**ISBN** 978-9980-905-19-2

## **Acknowledgements**

The Grade 5 Mathematics Teacher's Manual was developed by the Curriculum Development Division in partnership with the Mathematics specialists from Japan through the **Project for Improving the Quality of Mathematics and Science Education** known as **QUIS-ME Project**.

The Mathematics curriculum officers, textbook writers, pilot teachers from NCD and Central Provinces and the Subject Curriculum Group (SCG) are acknowledged for their contribution in writing, piloting and validating this textbook.

The Curriculum Panel (CP) members, members of the Subject Advisory Committee (SAC) and the Basic Education Board of Studies (BEBoS) are also acknowledged for their advice, recommendation and endorsement of this Teacher's Manual.

**A special acknowledgement is given to the People and the Government of Japan for the partnership and support in funding and expertise through Japan International Cooperation Agency (JICA) - QUIS-ME Project with Curriculum Development Division (CDD).**

# Mathematics Teacher's Manual

## Grade 5



Papua New Guinea  
**Department of Education**



From  
the People of Japan



## Table of Contents

Content	Page Number
Secretary's Message	I
How to use the Teacher's Manual	II
Unit 1. Decimal Numbers and Whole Numbers	1
Unit 2. Amount per Unit Quantity	11
Unit 3. Multiplication of Decimal Numbers	31
Unit 4. Congruence and Angles of Figures	49
Unit 5. Division of Decimal Numbers	75
Unit 6. Volume	97
Unit 7. Multiples and Divisors	119
Unit 8. Fractions	139
Unit 9. Addition and Subtraction of Fractions	163
Unit 10. Area of Figures	175
Unit 11. Multiplication and Division of Fractions	201
Unit 12. Proportion	219
Unit 13. Geometric Figures	233
Unit 14. Solids	251
Unit 15. Rate and Graph	267
Unit 16. Summary of the Grade 5	291
Attachment	
Teacher's Manual Development Committees	



## *Secretary's Message*

**Dear Teacher,**

The Mathematics Teacher's Manual is produced for Grade 5 teachers to guide them to plan and teach the Mathematics lessons jointly with the National Grade 5 Mathematics Textbook. It is designed for quality teaching and learning to achieve the implemented curriculum outlined in the Mathematics Syllabus.

The Teacher's Manual provides suitable teaching and learning strategies, content, concepts and plans for teachers to promote and maintain standard lessons for daily, termly and yearly teaching and learning activities nationwide. It guides critical thinking and problem solving approaches in which the teacher can easily visualise the concept in the lesson flow that is expanded from the textbook. It addresses necessary areas of what to teach, how to teach and what to assess.

The Teacher's Manual is user friendly and reflects PNG contexts in daily situations to help students acquire knowledge, skills, attitudes and values set through the lesson objectives. It guides teachers to deliver lessons to promote enjoyment and love of mathematics.

Some teachers are confident in teaching Mathematics while others find it challenging. This Teacher's Manual introduces many new approaches for lessons with more mathematics teaching aids, full utilisation of the blackboard using students' ideas and prior knowledge. It will help you, the teacher to teach mathematics processes step by step with necessary information to a standard or higher level. Therefore, you can demonstrate and improve your lessons with new teaching approaches through careful reading and preparation of each lesson using this Teacher's Manual.

You are encouraged to use the Teacher's Manual and Textbook with other relevant resources to deliver the mathematics contents with enjoyment and for your students to have fun and love mathematics.

I commend this Teacher's Manual for Grade 5 Mathematics to be used with the National Textbook as an official teaching resource in all primary schools throughout Papua New Guinea.

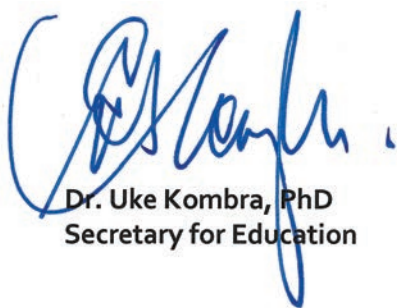

**Dr. Uke Kombra, PhD**  
**Secretary for Education**

# How to use the Teacher's Manual

## Introduction

It is important to understand the composition of the National Textbook in order to use the Teacher's Manual effectively. The Teacher's Manual (TM) has been developed for teachers to teach learning contents to their students more effectively with the National Textbook (TB). The features of this Teacher's Manual and its contents correspond to the National Mathematics Textbook according to Grades 3, 4 & 5 Mathematics Syllabus. The standards outlined in the syllabus are reflected in this Teacher's Manual to help teachers plan and conduct lessons. The Preliminary pages of the Teacher's Manual consists of the following 6 sections: **Components of the Teacher's Manual, Lesson Presentation using Textbook and Teacher's Manual, How to Use the Blackboard Plan, How to Conduct Assessment, Attachments and Yearly Overview.** It is important for you to take time to read and understand how to use the Textbook and the Teacher's Manual.

## 1. Components of the Teacher's Manual

### 1.1 Composition of the National Textbook

The composition of the National Textbook consists of the following features.

#### 1. Chapter Heading

Heading colour changes to assist teachers to recognise each teaching term.



#### 2. Titles and Numbers

Each chapter consists of Chapter and Sub-chapter titles with numbers. All problems in the textbook have Tasks and Activities including their numbers. We call **1** as task 1 and **1** as activity 1.

#### 3. Students' Ideas

Textbook uses students' ideas for students to think and reason mathematically. Basically, students learn using prior ideas to higher order thinking.

#### 4. Brainstorming Activity

Some chapters have Ice breaking activity as the lead up activity for the chapter.

#### 5. Fun with Mental Math!

$$\square \times \square = 29$$

The students can enjoy by filling in the boxes with numbers where the answer equates to the page numbers.

### Sample Textbook Page

**Chapter Number** 3

**Chapter Title** Multiplication of Decimal Numbers

**Introductory Picture** Connects the lesson with daily activity

**Sub-Chapter Title** Operation of Whole Numbers x Decimal Numbers

**Task Number** 1 The price of the ribbon is 80 toea per metre. Let's find out how much it would cost for 2.4 m.

**Activity Number** 1 Write a mathematical expression.

**Students' Ideas**

**Slider Mark** Students' activity or Problem solving

**Important Point**

**Priority Exercise Mark** Make sure teacher give this exercise during lesson.  $6.4 \times 3.5$

**Fun with Mental Math**  $\square + \square = 34$

## Key Competencies acquired through the use of the Textbook

Experimental mathematical activities such as **measure, compare, divide, order, touch, pile up** and **throw** are contained in all grades. It is intended to develop the ability and skills to be able to solve various problems logically in daily life by considering many ways.

## Mathematical Literacy

Activities for improving reading, expression and comprehension abilities and skills are contained in relating formulas, letters and graphs. In addition, the textbooks are designed in order to use acquired abilities and skills for future learning contents and daily life situations.

## Structure of a Chapter in the Textbook

The structure in the Chapters consist of several Sub-chapters, Tasks, Activities, Exercises and ends with a set of Exercise and Problems.

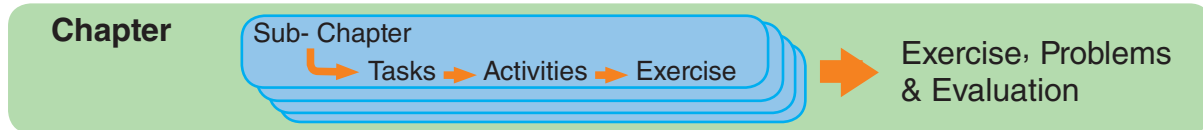

## Parts of the Textbook

### Textbook Introduction Page

The introduction page consists of two pages which introduces very important information and icons allowing students and teachers to be familiar with what is expected to be encountered in

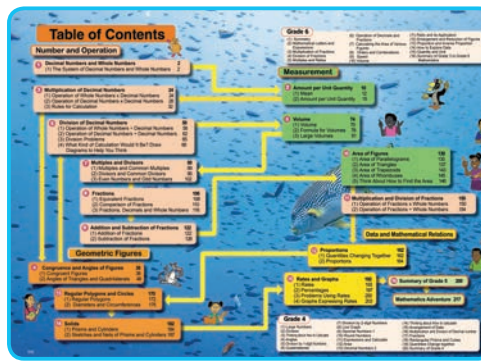
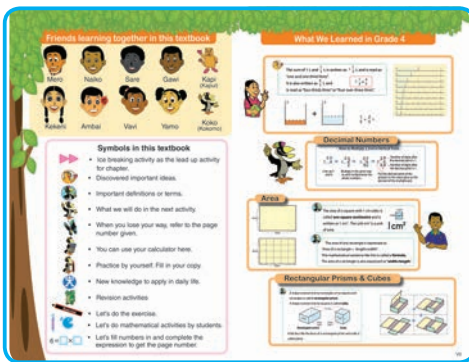

the textbook. It also has chapters learned from previous grade outlined carefully in a table of contents. It promotes sequences of learning to help teachers to plan and program effectively.

### Exercise & Problems

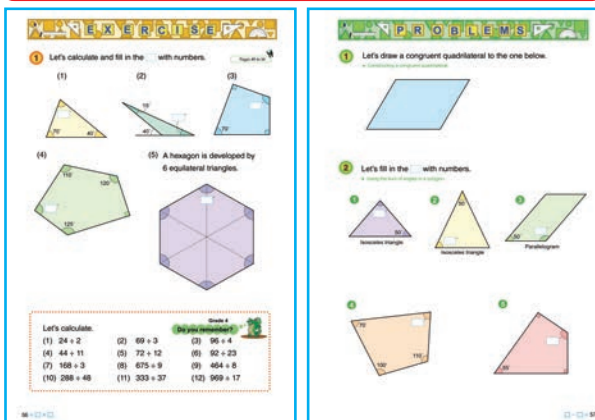

At the end of each chapter, Exercises are set for students to consolidate what has been learned in a particular chapter. Page numbers indicating specific content found for each exercise is tagged beside each exercise.

The Problems are placed after each exercise in each chapter. The problems are more advanced in order to enhance students higher order thinking skills for each chapter. It also guides students to apply what they have learned.

### Revision "Do you remember?"

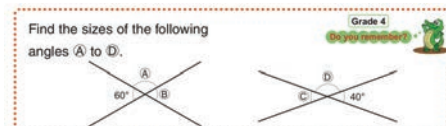

This section of the textbook is purposely for revision. Before moving on to the next chapter, these set of exercises will enable students to reflect to the contents covered in the past and relate to the new chapter. This also promotes consolidating of previous content.

### Additional Information - Mathematics Extra

#### Sieve of Eratosthenes

Determine a prime number that is less than 100 by the next procedure.

- ① Erase 1.
- ② Leave 2 and erase multiple of 2.
- ③ Leave 3 and erase multiple of 3.

Like this, leave the first numbers and erase its multiples. Using this method, a prime number like 2, 3, 5, 7, 11, etc, are left.



Additional information is placed in some units to relate the content covered to cultural and social aspects of life. It helps the students to think mathematically in solving daily life situations.

## 1.2 Main content of the Teacher's Manual

The layout of the Teacher's Manual has 9 components: **Lesson Information, Sub-Unit and Lesson Objectives, Prior Knowledge, Assessment, Preparation, Lesson Flow, Teacher's Note, Sample Blackboard Plan and Reduced Textbook page of the lesson.** The information given in each component will help in preparing and conducting lessons. Therefore, it is strongly recommended that the manual is read and understood before planning each lesson. Teachers should use Chapters and Sub-Chapters in the textbook and Units and Sub-units in the Teachers' Manuals.

### Lesson Information

Basic information consists of **Unit Number, Unit Title, Sub-Unit or Topic and Lesson number** for each sub-unit. The **Textbook Page** and **Actual Lesson Number** is indicated for easier reference.

### Sub-unit Objective

Each Unit consists of one or more sub-units and is indicated only at the beginning of each sub-unit. The sub-unit objectives explain specific Attitudes, Skills, Knowledge and Mathematical Thinking (ASK-MT) which should be achieved in this sub-unit.

### Lesson Objective

Objectives capture the ASK-MT of every lesson that should be achieved.

### Prior Knowledge

Prior knowledge describes contents that students should have acquired before the new lesson. In the case where students are not ready to learn new concepts, the teacher can identify which contents to review and refer back to while teaching.

## Sample Teacher's Manual Page

**Unit 11** Unit: Multiplication and Division of Fractions  
Sub-unit: 1. Operation of Fractions  $\times$  Whole Numbers  
Lesson 1 of 3  
Textbook Page: p.145 - 147  
Actual Lesson 101

**Sub-unit Objectives**

- To understand the meaning and how to calculate fraction multiplied by a whole number.

**Lesson Objectives**

- To think about how to calculate fraction multiplied by a whole number.
- Calculate fraction multiplied by a whole number.

**Prior Knowledge**

- Fraction in Grade 4

**Preparation**

- Chart and table for task 1 and activity 2.

**Assessment**

- Think about how to calculate (Fraction)  $\times$  (Whole number). **F**
- Understand how to calculate (Fraction)  $\times$  (Whole number). **S**

**Teacher's Notes**

- Remind students to represent improper fractions to proper fractions as their final answer.
- From Yamo's idea on  $2 \div 5 \times 3 = 2 \times 3 \div 5$ , it is learned in Gr. 5 vol 1 that:
  - $(2 \div 5) \times 3 = 0.4 \times 3 = 1.2$  and
  - $(2 \times 3) \div 5 = 6 \div 5 = 1.2$

**Reduced Textbook page of the lesson**

**11 Multiplication and Division of Fractions**

**1. Operation of Fractions  $\times$  Whole Numbers**

**Meaning of Fraction  $\times$  Whole Number**

Yamo and Sprinkler with a bucket of water. When we use a large bucket, we can sprinkle  $2 \text{ m}^2$  for each time. When we use a small bucket, we can sprinkle  $\frac{2}{5} \text{ m}^2$  for each time.

If we sprinkle three times with a large bucket, what  $\text{m}^2$  can we sprinkle water?

Write an expression and find the number.

If we sprinkle three times with the small bucket, how many  $\text{m}^2$  can we get? Let's compare in the table below.

Area (m <sup>2</sup> )	Number of Sprinkling Times
2	3
$\frac{2}{5}$	3

Let's write an expression of  $\frac{2}{5} \times 3$ .

Let's think about how to calculate.

Let's think about situations where you multiply fraction by a whole number and how to calculate it.

**Share's Idea**

Let's represent this fraction by division.

We get  $\frac{2}{5} \times 3 = 2 \div 5 \times 3$

$2 \div 5 = 0.4$

$0.4 \times 3 = 1.2$

$2 \div 5 \times 3 = 2 \times 3 \div 5 = 6 \div 5 = 1.2$

**Yamo's Idea**

Represent this fraction by division.

We get  $\frac{2}{5} \times 3 = 2 \div 5 \times 3$

$2 \div 5 = 0.4$

$0.4 \times 3 = 1.2$

Represent the expression as one fraction.

We get  $\frac{2}{5} \times 3 = \frac{2 \times 3}{5} = \frac{6}{5} = 1.2$

**How to calculate (fraction)  $\times$  (whole number)**

Sprinkling 4 times with the small bucket in  $\text{E}$ . How many  $\text{m}^2$  can you water? Let's write an expression and calculate.

$\frac{2}{5} \times 4 = \frac{2 \times 4}{5} = \frac{8}{5} = 1.6$  Answer:  $1.6 \text{ m}^2$

### Reduced Textbook page of the lesson

Corresponding textbook page is shown at the bottom of the left page.

The following are written in the page.

- Lesson span** :Where the lesson begins  $\nabla$  and ends  $\nabla$  is indicated. ★
- Answers and solutions of the Tasks, Activities, Problems and Exercises. ★
- Teaching points such as; Purpose of the Tasks, Exercises and Problem types and characteristics of the problem, calculation and concepts. ★



### Assessment

There are two types of assessments in this Teacher's Manual, 'Formative **F**' and 'Summative **S**'. The details are shown on page IX.



### Preparation

The preparation specifies the materials or resources which are recommended for use in the lesson. Some materials may not be available or accessible in the local community. In such cases, teachers are encouraged to improvise or replace them with other relevant and available materials.

### Lesson flow

The lesson flow consists of several teaching points that will help in the understanding and visualisation of the lesson sequence. It is important to read this part in preparation for the lesson.

- T** : What the teacher should do and say during the lesson.
- TN** : Supplementary information or key ideas and points that should be considered when conducting the lesson.
- S** : Students' expected responses and what they are expected to do during the lesson.
- T/S** : Instruction for both teacher and students to carry out together.

- 1** The number in the square corresponds to the "Task" in the textbook. 
- 1** The number in the circle corresponds to the Activity in the Textbook content of the lesson. Important point to be emphasised during the lesson are indicated by the dotted boxes below;
  -  Important Ideas
  -  Important Definitions or Terms

### Sample Blackboard Plan

Shows a plan of how the blackboard can be arranged and must be utilised as a guide. Refer to page VII for more details.

### Teacher's Notes

Contains supplementary information that is useful for teachers and enhances their content background knowledge as well.

It is very important to read these information before conducting the lesson to understand the objective of the lesson.



**Lesson Flow**

<p><b>1</b> <b>Meaning of Fraction <math>\times</math> Whole number.</b></p> <p><b>T</b> Introduce the picture of the new unit and have pre-discussion.</p> <p><b>S</b> Read and understand the situation using the table.</p> <p><b>T</b> Introduce the main task.</p> <p><b>TN</b> If we sprinkle three times with the large plastic container, what <math>m^2</math> can we get?</p> <p><b>S</b> Write a mathematical expression using the table as <math>2 \times 3</math>.</p> <p><b>S</b> Solve the problem. i.e. <math>2 \times 3 = 6</math></p> <p><b>T</b> If we sprinkle three times with the small plastic container, how many <math>m^2</math> can we get?</p> <p><b>T</b> Explain the diagram and table.</p> <p><b>TN</b> Assist students to colour the part for 1 time first, then colour in the part for 3 times.</p> <p><b>S</b> Using the table write a mathematical expression as <math>\frac{2}{5} \times 3</math>.</p> <p><b>S</b> Think about how to calculate and present own ideas</p> <p><b>T</b> Confirm and explain students ideas using Sare and Yamo's ideas.</p>	<p><b>2</b> <b>How to calculate (fraction) <math>\times</math> (whole number).</b></p> <p><b>T</b> Explain the diagram and table.</p> <p><b>TN</b> Assist students to colour the part for 1 time first, then colour in the part for 4 times.</p> <p><b>S</b> Write an expression and calculate using Sare and Yamo's idea.</p> <p><b>TN</b> <math>\frac{2}{5} \times 4 = \frac{2 \times 4}{5}</math></p> <p><b>3</b> <b>Important point</b></p> <p><b>T</b> Explain the important point in the box relating it to <math>\frac{2}{5} \times 3</math> and <math>\frac{2}{5} \times 4</math>.</p> <p><b>4</b> <b>Summary</b></p> <p><b>T</b> What have you learned in this lesson?</p> <p><b>S</b> Present ideas on what they have learned.</p> <p><b>T</b> Use students' ideas to confirm the important concepts of this lesson.</p>
---	--

Follow the lesson flow step by step! Use prior knowledge and students' ideas to create child centered lessons.



**Sample Blackboard Plan**

<p>Date: _____ Chapter: 10. Multiplication and Division of Fraction Topic: Fraction <math>\times</math> Whole Number</p> <p><b>Main task:</b> Let's think about situations where you multiply fraction by a whole number and how to calculate it.</p> <p><b>1</b> When we use a large bucket, you can sprinkle <math>2m^2</math> for each time. When we use a small bucket, we can sprinkle <math>\frac{2}{5}m^2</math> for each time.</p> <p><b>1</b> Sprinkle three times with the large bucket, what <math>m^2</math> can we water?</p> <table border="1" style="width: 100%; text-align: center; border-collapse: collapse;"> <tr> <td>Number of buckets</td> <td>2</td> <td>3</td> </tr> <tr> <td>Area watered</td> <td>4</td> <td>6</td> </tr> </table> <p>Expression: <math>2 \times 3</math></p>	Number of buckets	2	3	Area watered	4	6	<p><b>2</b> Sprinkle three times with the small bucket, how many <math>m^2</math> can you water?</p> <table border="1" style="width: 100%; text-align: center; border-collapse: collapse;"> <tr> <td>Number of buckets</td> <td>3</td> </tr> <tr> <td>Area watered</td> <td><math>\frac{6}{5}</math></td> </tr> </table> <p>Expression: <math>\frac{2}{5} \times 3</math></p> <p><b>3</b> Let's write an expression of <b>2</b></p> <table border="1" style="width: 100%; text-align: center; border-collapse: collapse;"> <tr> <td>Number of buckets</td> <td>4</td> </tr> <tr> <td>Area watered</td> <td><math>\frac{8}{5}</math></td> </tr> </table> <p>Let's think about how to calculate.</p> <p><b>Yamo's idea</b></p> <p><math>\frac{2}{5} \times 3 = 2</math> sets of <math>\frac{1}{5}</math> and <math>\frac{2}{5} \times 3 = 3</math> sets of <math>\frac{1}{5}</math></p> <p>Hence, <math>\frac{2}{5} \times 3 = (2 \times 3)</math> sets of <math>\frac{1}{5}</math></p> <p>So, <math>\frac{2}{5} \times 3 = \frac{2 \times 3}{5} = \frac{6}{5} = 1\frac{1}{5}m^2</math></p>	Number of buckets	3	Area watered	$\frac{6}{5}$	Number of buckets	4	Area watered	$\frac{8}{5}$	<p>Lesson Number: 1 on Yamo's idea</p> <p>Fraction by division: <math>\frac{2}{5} \times 3 = 2 \div \frac{5}{3} = 2 \times \frac{3}{5} = \frac{2 \times 3}{5}</math></p> <p>Write as 1 fraction: <math>= (2 \times 3) \div 5</math></p> <p>we get: <math>\frac{2}{5} \times 3 = \frac{2 \times 3}{5} = \frac{6}{5} = 1\frac{1}{5}m^2</math></p> <p><b>2</b> Sprinkle 4 times with the small bucket how many <math>m^2</math> can you water?</p> <table border="1" style="width: 100%; text-align: center; border-collapse: collapse;"> <tr> <td>Number of buckets</td> <td>4</td> </tr> <tr> <td>Area watered</td> <td><math>\frac{8}{5}</math></td> </tr> </table> <p><math>\frac{2}{5} \times 4 = \frac{2 \times 4}{5} = \frac{8}{5} = 1\frac{3}{5}m^2</math></p> <p><b>Summary</b></p> <p>When we multiply a proper fraction by a whole number, multiply the numerator by the whole number and keep the denominator as it is.</p>	Number of buckets	4	Area watered	$\frac{8}{5}$
Number of buckets	2	3																		
Area watered	4	6																		
Number of buckets	3																			
Area watered	$\frac{6}{5}$																			
Number of buckets	4																			
Area watered	$\frac{8}{5}$																			
Number of buckets	4																			
Area watered	$\frac{8}{5}$																			

V

## 1.3 Other Contents: Chapter Introduction Page

The Chapter Introduction page is found at the beginning of every Unit and consists of the Unit Objectives with specific numerical representations of the Content Standards and Performance Standards in the Syllabus, Teaching Overviews and Related Learning Contents.

### 1. Content Standard

The Content Standards outlines the expected content to be attained in this grade and is outlined in the syllabus, comprising of the facts, concepts and ideas that are important for the students.

### 2. Unit Objective

The Unit Objective outlines the key ASK-MT that students are expected to learn or acquire at the end of each unit. There may be one or more unit objectives for each unit depending on the unit depth and content.

### 3. Teaching Overview

The Teaching Overview outlines the main content areas to be covered in each unit with sub units briefly described to rationalise an overview of the unit. This section can also assist the teachers to be aware of the type of content expected in each unit and prepare in advance.

### 4. Related Learning Content

Related Learning Content outlines the content map of what the students have learned already, in-line with the current unit to be taught. The previous content covered will serve as the foundation for students to learn new concepts and contents. Furthermore, the current unit to be learned is also linked to the next learning area and grade level.

The three digits such as 5.1.3 represents the grade level (5), strand (1), and the content standard (3). The expansion of the content standard is further outlined in the Unit Objective.

### Chapter 12 Proportions

#### 1. Unit Objectives

- To analyse the two changing quantities by observing the table. (5.4.11a)
- To understand the proportion of two quantities. (5.4.1b and c)
- To deepen the understanding of equations that shows the relation of two quantities. (5.4.1b)

#### 2. Teaching Overview

This is the first unit for learning proportions though they already built some foundations in the previous grades such as quantities changing together expressed as line graphs or mathematical sentences using  $\square$  and  $\triangle$ . In grade 5, students will deepen the understanding of mathematical sentences using  $\square$  and  $\triangle$ , and get familiar with simple proportional relationship. Further learning will be expected in Grade 6.

**Two changing quantities :** Students put appropriate values in a table based on a situation given and pay attention to changing quantities and constant. They replace the changing quantities by  $\square$  and  $\triangle$ . Students are to be given enough opportunities to interpret and use the expressions with  $\square$ ,  $\triangle$  and  $\triangle$ .

**Proportions :** Many situations should be thought in this topic to investigate the patterns of changes and relationships of values corresponding.

#### 3. Related Learning Contents

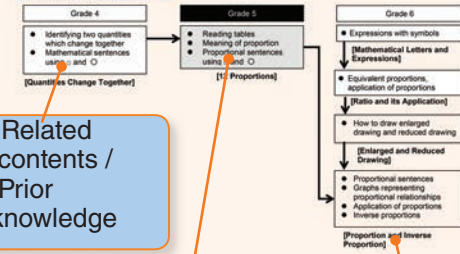

Related contents / Prior knowledge

Gray box: Indicate current Grade and chapter contents

Chapter # & Name

## 1.4 Other Contents: End of Chapter Test

At the end of each unit in the Teacher's Manual, there is an attached End of Chapter Test. The test is purposely conducted to measure how much content and mathematical concepts the students have understood and acquired for each Chapter. This will also help teachers and students to understand better and observe vital areas to be improved in both teaching and learning.

The test should be conducted as a **separate lesson** to confirm students progress or as assessment. Answers to the end of chapter test is located before a page of End of Chapter Test as sample on left.

End of Chapter Test

Chapter 11: Multiplication and Division of Fractions

Name: \_\_\_\_\_ Date: \_\_\_\_\_ Score: \_\_\_\_\_ / 100

1. Calculate. (6 × 10 marks = 60 marks)

(1)  $\frac{1}{3} \times 5$  (2)  $\frac{2}{3} \times 6$

Answer: \_\_\_\_\_ Answer: \_\_\_\_\_

(3)  $1\frac{1}{10} \times 5$  (4)  $\frac{1}{6} \div 4$

Answer: \_\_\_\_\_ Answer: \_\_\_\_\_

(5)  $2\frac{2}{3} \div 26$  (6)  $2\frac{2}{3} \div 12$

Answer: \_\_\_\_\_ Answer: \_\_\_\_\_

2. Answer the following questions. (10 marks or maths expression and 10 marks for the answer)

(1) Find the weight of 8 coins of  $1\frac{2}{3}$  g each in g.

Mathematical Expression: \_\_\_\_\_ Answer: \_\_\_\_\_

(2) Find the share of rice for 1 person in kg if 7 people share  $\frac{3}{4}$  kg of it equally.

Mathematical Expression: \_\_\_\_\_ Answer: \_\_\_\_\_

End of Chapter Test

End of Chapter Test

Chapter 11: Multiplication and Division of Fractions

Name: \_\_\_\_\_ Date: \_\_\_\_\_ Score: \_\_\_\_\_ / 100

1. Calculate. (6 × 10 marks = 60 marks)

(1)  $\frac{1}{3} \times 5 = \frac{5}{3}$  (2)  $\frac{2}{3} \times 6 = 4$

Answer:  $\frac{5}{3}$  or  $1\frac{2}{3}$  Answer: 4

(3)  $1\frac{1}{10} \times 5 = \frac{11}{2}$  (4)  $\frac{1}{6} \div 4 = \frac{1}{24}$

Answer:  $\frac{11}{2}$  or  $5\frac{1}{2}$  Answer:  $\frac{1}{24}$

(5)  $2\frac{2}{3} \div 26 = \frac{13}{26} = \frac{1}{2}$  (6)  $2\frac{2}{3} \div 12 = \frac{11}{5} \times \frac{1}{12} = \frac{11}{60}$

Answer:  $\frac{1}{2}$  Answer:  $\frac{11}{60}$

2. Answer the following questions. (10 marks or maths expression and 10 marks for the answer)

(1) Find the weight of 8 coins of  $1\frac{2}{3}$  g each in g.

Mathematical Expression:  $1\frac{2}{3} \times 8$  Answer:  $\frac{34}{3}$  g or  $12\frac{2}{3}$

(2) Find the share of rice for 1 person in kg if 7 people share  $\frac{3}{4}$  kg of it equally.

Answers of End of Chapter Test

Please use the evaluation test in each chapter to confirm students' progress and challenge each step for delivering the best lessons!!



## 2. Lesson Presentation using Textbook and Teacher's Manual

In every lesson preparation, teachers should always consider what to do before, during and after the lesson. Both the Teacher's Manual and Textbook must be used to conduct a successful lesson.

### 2.1 Lesson Preparation

When preparing a mathematics lesson the following requirements should be considered;

1. Ensure to have both Textbook and Teacher's Manual and read and understand the lesson content.
2. Review previous lesson and understand the next day's lesson before delivering the current lesson.
3. Work out and be familiar with the answers to the activities and exercises in advance.
4. Study the lesson flow, relate to the blackboard plan and visualise how to use it.
5. Prepare teaching materials prior to the lesson.
6. Plan and prepare according to the recommended time.

### 2.2 Lesson Presentation

When you have prepared your lesson, you should now be ready to present your lesson. Consider the following points during the lesson.

1. Have only the Teacher's Manual during the presentation of the lesson.
2. Review students prior knowledge.
3. Present the task or problem situation from the textbook.
4. Encourage problem solving approach and facilitate group or general discussions.
5. Analyse and consider students' opinions or findings and always direct misconceptions back to the main concept. (Formative Assessment)
6. Encourage students to do homework for consolidation of skills. (Formative and Summative Assessment)
7. Assist students to master the skills in the lesson content through the exercises and problems. (Formative and Summative Assessment)
8. Evaluate and summarise important points, concepts or ideas learned and predict what is expected to be learned in the next lesson.

#### Must Dos

- Strictly follow Teachers Manual with reference to the Textbook.
- Conduct experimental activities when necessary.
- Expansion of student ideas in the textbook.
- Involve students in outdoor exercises when required to.
- Encourage students to use mathematical tools or instruments appropriately for its purpose.
- Encourage more student interactions.
- Every lesson is important as concepts are linked from one lesson to the next lesson.

### 2.3 Lesson Evaluation

After the lesson, teachers should reflect on the lesson taught and evaluate students achievements and do self reflection.

These can be done through:

1. Marking of exercises or tasks done.
2. Observation checklists.
3. Review of blackboard plan.
4. Student responses during summary of the lesson.
5. Making adjustments based on the evaluation to improve teaching strategies may require re-teaching.

### 3. How to Use the Blackboard Plan

The Blackboard is an important tool for teachers to use daily. This Teacher's Manual introduces the strategy for enhancing the effective use of the blackboard to improve student learning. The whole blackboard should be utilised fully from left to right corresponding to the lesson flow.

Use the blackboard according to the following steps.

1. Ensure that the whole blackboard is clean.
2. Write Date, Chapter, Topic and lesson number from the top left hand corner to the right.
3. Follow the sequence of the lesson working from left to right according to the blackboard plan including:
  - a) Main Task Heading (MT)
  - b) Review
  - c) Student Ideas and textbook ideas
  - d) Important points
  - e) Tasks and activities (practices)
  - f) Summary (All of the components will depend and correspond with the flow of the lesson.)

Points to consider.

1. Write in a very organised manner so the students can see connections and is visible from all parts of the room.
2. Check what you write as you write for students to copy it down in their exercise books to learn.
3. Encourage students to display their ideas on the blackboard by writing and explaining what they have learned and promote student centred learning.
4. Allow students sufficient time to copy what you wrote.  
(Students should copy only the important points, not necessary to copy all.)



At the end of the lesson, it is time for summary of the lesson. Teachers should summarise using whole blackboard to point out important points.

**Activity**

**Date:** Chapter: 1 Decimal Numbers and Whole Numbers. **Topic:** Structure of the whole and decimal numbers. **Lesson No:** 1/3

**Main Task:** Let's think about how to compare the systems of whole numbers and decimal numbers.

Write each number in the table below.

	Thousands	Hundreds	Tens	Ones	Tenths	Hundredths	Thousandths
Altitude of Kundliawa	1	4	5	6			
Length of laplap				1	4	5	6

Compare the altitude of Kundliawa Town and the length of the laplap. What do you notice about the two numbers?

**Task** (MT) Let's compare the two numbers 1456 and 1.456

The altitude of Kundliawa Town is 1 456 m. The length of the laplap with designs is 1.456 m.

Express each number by expression.

$$1,456 = 1,000 + 400 + 50 + 6 = 1,000 \times + 100 \times + 10 \times + 1 \times$$

$$1,456 = 1 + 0.4 + 0.05 + 0.006 = x \times + 0.1 \times + 0.01 \times + 0.001 \times$$

Compare and discuss the systems of the whole numbers and decimal numbers.

Let's think about the system of numbers.

Let's compare the calculations  $132 + 47$  and  $1.32 + 4.7$

$$\begin{array}{r} 132 \\ +47 \\ \hline 179 \end{array} \quad \begin{array}{r} 1.32 \\ +4.7 \\ \hline 5.02 \end{array}$$

3 sets of , 2 sets of , 7 sets of

**Important Point**

**Exercise**

Let's make numbers using the ten digits from 0 to 9 once each time and a decimal point. Write the smallest number. 0.1

**Summary**

- The structure of the whole numbers shift to the next higher place when multiplied by 10.
- The structure of the whole numbers shift to the next lower place when multiplied by 1/10.

**Summary**

MT: **Main Task mark**

The Main Task is introduced as indicated on the Sample Blackboard Plan according to the lesson flow. In this sample blackboard plan, the teacher writes and explains the main task, then proceeds with **1** (Task 1) **1** and **2** (activities 1 and 2).

## 4. How to Conduct Assessment

Assessment is a fundamental aspect of students mathematical learning and performance. Results of assessment will benefit the students in setting goals, take high responsibility for their own learning and become more independent learners.

There are two main types of assessment used in this book which is in line with the syllabus assessment to assess the students.

They are:

1. Formative Assessment (Assessment For or As)
2. Summative Assessment (Assessment Of)

This should guide teachers to prepare assessment tasks and methods.

You will find summative **S** and formative **F** assessment indicated in every lesson so it is important for you to plan how you want to assess students' learning and performance.

### **F** Formative assessment

Formative assessment examples in the Teacher's Manual:

- Observation checklists
- Correction of exercises
- Analysis of discussions
- Students' participation.

### **S** Summative assessment

Summative assessment examples include:

- Exercise and Problems
- End of Chapter Test
- Projects
- Homework and Assignments.

## 5. Attachments

The Teacher's Manual has four attached pages that the teacher can use when teaching lessons. The pages consist of a Mathematics game information, Contents Chart and dotted grids (5 mm<sup>2</sup> grid, a 1 cm<sup>2</sup> grid, a 1 cm<sup>2</sup> ) and triangle rulers and a protractor.

1. **Mathematics game information**
2. **Content Chart from Elementary Prep to Grade 8**
3. **5 mm<sup>2</sup> grid**

The 5 mm<sup>2</sup> grid can be used for drawing graphs, sketching nets or solids and drawing various figures with 5 mm scale.

4. **1 cm<sup>2</sup> grid**  
The 1 cm<sup>2</sup> grid can be used for drawing graphs, sketching nets or solids and drawing with 1 cm scale.

5. **1 cm<sup>2</sup> dotted grid**  
The 1 cm<sup>2</sup> dotted grid can be used for drawing various lines, shapes or figures.

6. **Triangle rulers and protractor**  
The triangle rulers and protractor can be used to draw shapes and figures, measure and confirm lengths and angles.

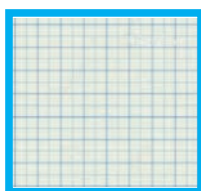

These attachments can be photocopied and given to students when materials are not available in schools.



## 6. Yearly Overview

**Yearly overview** is an essential and systematic plan of the grade content. It is helpful in the preparation of the yearly program to effectively plan for teaching strategies. The strand is outlined and identifies each unit and topic into different strand groups. The units are in sequential order from the first to the last unit.

Strand	Unit #	Unit Name and Sub-unit Name	Lesson #	Page #
Number and Operation	1	<b>Decimal Numbers and Whole Numbers</b>		<b>2</b>
		1. The System of Decimal Numbers and Whole Numbers	1	2,3,4,5
			2	5,6
			3	7
		Exercise, Problems and Evaluation	4,5	8,9
Measurement	2	<b>Amount per Unit Quantity</b>		<b>10</b>
		1. Mean	6	10,11,12
			7	13
			8	14
		2. Amount per Unit Quantity	9	15,16
			10	17
			11	18
			12	19
		Exercise, Problems and Evaluation	13	20,21
		14,15	22,23	
Number and Operation	3	<b>Multiplication of Decimal Numbers</b>		<b>24</b>
		1. Operation of Whole Numbers x Decimal Numbers	16	24,25,26
			17	26,27
		2. Operation of Decimal Numbers x Decimal Numbers	18	28
			19	29,30
		3. Rules for Calculation	20	31
			21	32
		Exercise, Problems, Evaluation and Mathematics Extra	22	33,34
23,24	35,36,37			
Geometric Figures	4	<b>Congruence and Angles of Figures</b>		<b>38</b>
		1. Congruent Figures	25	38,39,40
			26	40,41
			27	42,43
			28	44,45,46
			29	46
		Exercise	30	47
		2. Angles of Triangles and Quadrilaterals	31	48,49,50
			32	50
			33	51,52
			34	53,54,55
			35	55
		Exercise, Problems and Evaluation	36,37	56,57
Number and Operation	5	<b>Division of Decimal Numbers</b>		<b>58</b>
		1. Operation of Whole Numbers ÷ Decimal Numbers	38	58,59,60
			39	61
		2. Operation of Decimal Numbers ÷ Decimal Numbers	40	62,63
			41	64
		3. Division Problems	42	65
			43	66
			44	67
		4. What Kind of Calculation Would It Be? Draw Diagrams to Help You Think	45	68,69
		Exercise, Problems and Evaluation	46,47	70,71
Comparing Lengths	48	72,73		

Under each unit in the Overview, the topics for each lesson are also indicated. For all topics, the actual lesson numbers are given according to the student textbook. Column of Unit Names are highlighted by term colours such as term1: green, term2: orange, term3: blue and term 4: Pink. Finally, page numbers are attached to each lesson to easily identify the lesson topics for planning.  
**Note:** In the Yearly overview, the term 'units' is used while the term 'chapter' is used in the textbook.

Strand	Unit #	Unit Name and Sub-unit Name	Lesson #	Page #
Measurement	6	<b>Volume</b>		<b>74</b>
		1. Volume	49	74,75
			50	76,77
		2. Formula for Volumes	51	78,79
			52	79,80
		3. Large Volumes	53	81
			54	82
			55	83
			55	83,84
				57
		58,59	86,87	
Number and Operation	7	<b>Multiples and Divisors</b>		<b>88</b>
		1. Multiples and Common Multiples	60	88,89,90
			61	91,92,93
			62	94
		2. Divisors and Common Divisors	63	95,96,97
			64	97,98
			65	99,100
			66	100,101
		3. Even Numbers and Odd Numbers	67	102
		Exercise, Problems, Evaluation and Mathematics Extra	68,69	103,104,105
Number and Operation	8	<b>Fractions</b>		<b>106</b>
		1. Equivalent Fractions	70	
			71	110,111
		2. Comparison of Fractions	72	112
			73	113
			74	114,115
		3. Fraction, Decimals and Whole Numbers	75	116,117
			76	117
			77	118
			78	119
		79	120	
Exercise and Evaluation	80,81	121		
Number and Operation	9	<b>Addition and Subtraction of Fractions</b>		<b>122</b>
		1. Addition of Fractions	82	122,123,124
			83	125
		2. Subtraction of Fractions	84	126,127
			85	127,128
Exercise and Evaluation	86,87	129		
Measurement	10	<b>Area of Figures</b>		<b>130</b>
		1. Area of Parallelograms	88	130,131,132
			89	133,134
			90	135
			91	136
		2. Area of Triangles	92	137,138,139
			93	140
			94	141
			95	142
		3. Area of Trapezoids	96	143,144
4. Area of Rhombuses	97	145		
5. Think About How to Find the Area	98	146		
Exercise, Problems, Evaluation and Mathematics Extra	99,100	147,148,149		

Strand	Unit #	Unit Name and Sub-unit Name	Lesson #	Page #
Number and Operation	11	<b>Multiplication and Division of Fractions</b>		<b>150</b>
		1. Operation of Fractions $\times$ Whole Numbers	101	150,151,152
			102	152
			103	153
		2. Operation of Fractions $\div$ Whole Numbers	104	154,155
			105	156
			106	157
		Exercise, Problems, Evaluation and Mathematics Extra	107,108,109	158,159,160,161
Data and Mathematical Relations	12	<b>Proportions</b>		<b>162</b>
		1. Quantities Changing Together	110	162,163
		2. Proportions	111	164,165
			112	166
			113	167
				Exercise, Problems and Evaluation
Geometric Figures	13	<b>Regular Polygons and Circles</b>		<b>170</b>
		1. Regular Polygons	117	170,171,172
			118	173
			119	174
		2. Diameters and Circumferences	120	175
			121	176
			122	177,178
			123	178,179,180
		Exercise and Evaluation	124,125	181
Geometric Figures	14	<b>Solids</b>		<b>182</b>
		1. Prisms and Cylinders	126	182,183
			127	184,185
			128	185,186
		2. Sketches and Nets of Prisms and Cylinders	129	187
			130	188
			131	189
		Exercise, Problems and Evaluation	132,133	190,191
Data and Mathematical Relations	15	<b>Rates and Graphs</b>		<b>192</b>
		1. Rates	134	192,193,194
			135	194,195
			136	196
		2. Percentages	137	197,198
			138	198,199
		3. Problems Using Rates	139	200
			140	201
			141	202
		4. Graphs Expressing Rates	142	203,204
143	205,206			
		Exercise and Evaluation	144,145	207
Summary	16	<b>Summary of Grade 5</b>		<b>208</b>
		1. Applying Mathematics in Daily Life	146	208,209
		2. Numbers and Calculations	147	210,211
		3. Measurement	148	212,213
		4. Shapes and Figures	149	214,215
		5. Relationship among Quantities	150	216
		Supplementary Topic: Mathematics Adventure	151-161	217



# Chapter 1 Decimal Numbers and Whole Numbers

## 1. Content Standard

5.1.3 Use base 10 system representation to compare and convert whole number to decimal numbers.

## 2. Unit Objectives

- To deepen the understanding about whole number and decimal number through considering decimal numeration system.
- Multiply a number by 10 times, 100 times,  $\frac{1}{10}$  or  $\frac{1}{100}$ .

## 3. Teaching Overview

Students learned large whole numbers and decimal numbers with up to thousandths in the previous grades. In this unit, they learn decimal numbers and whole numbers comprehensively in the same binary number system. Number place table will help students to understand how numbers slip off as they make the original number 10 and 100 times or tenths and hundredths though the arrangement of numbers does not change.

## 4. Related Learning Contents

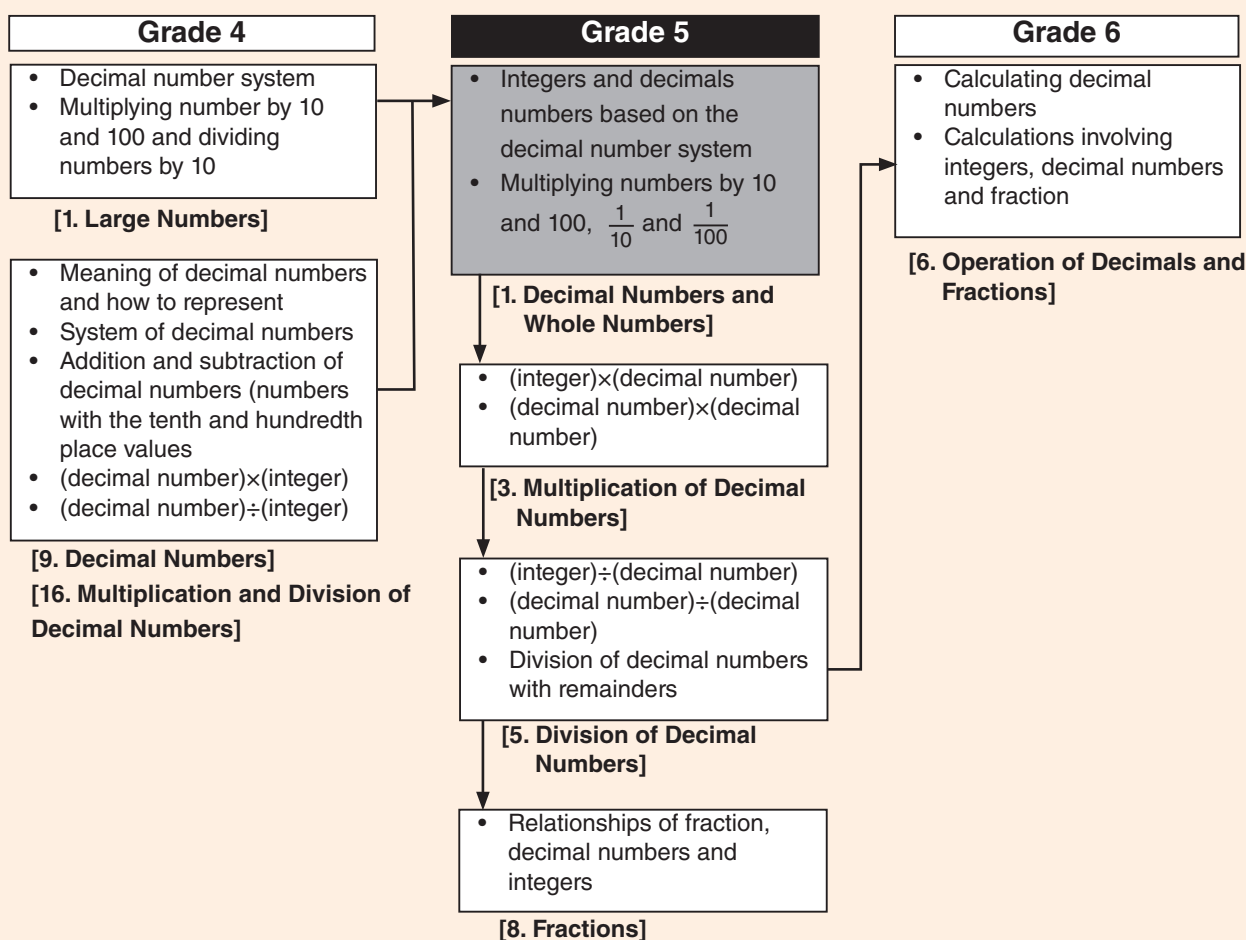

# Unit 1

## Unit: Decimal Numbers and Whole Numbers

### Sub-unit 1: The System of Decimal Numbers and Whole Numbers

#### Lesson 1 of 3

Textbook Pages :  
002 to 005  
Actual Lesson 001

### Sub-unit Objective

- To deepen the understanding about the structure of whole numbers and decimal numbers.

### Lesson Objectives

- To understand that a decimal and whole number have the same structure.
- To deepen understanding about the system of decimal numbers.

### Prior Knowledge

- Decimal numbers up to hundredth place (Grade 4)

### Preparation

- Diagram of the structure of whole numbers and decimal numbers on pages 2 and 3

### Assessment

- Enjoy comparing the structure of whole numbers and decimal numbers. **F**
- Demonstrate the understanding of the structure of decimal numbers by completing the tasks. **S**
- Solve the exercises correctly. **S**

### Teacher's Notes

Notice that the cube diagram in the textbook is magnified. From ones place value on page 2 is further broken down to the thousandths place on page 3.

In fact, the size of the bigger block is reduced to a single cube and when seen through a magnifying lens, the emphasis is to visualise that the structure of the whole number and decimals is the same.

1

## Decimal Numbers and Whole Numbers



The altitude of Kundiawa town is 1456 m above sea level. Simbu Province

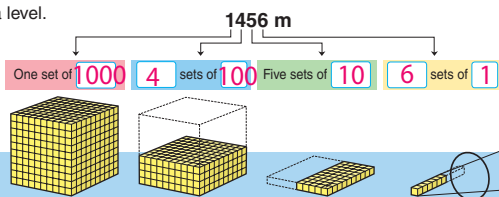

### The System of Decimal Numbers and Whole Numbers

1 Let's compare the two numbers in the pictures, 1456 and 1.456

1 Fill the  with set of numbers as above.

2 Look at the pictures of the blocks and discuss what you have noticed with your friends.

3 Express each number by the expressions as shown below.

$$1456 = 1000 + 400 + 50 + 6$$

$$= 1000 \times 1 + 100 \times 4 + 10 \times 5 + 1 \times 6$$

$$1.456 = 1 + 0.4 + 0.05 + 0.006$$

$$= 1 \times 1 + 0.1 \times 4 + 0.01 \times 5 + 0.001 \times 6$$

We can say that 1.456 is made up from 1 set of 1, 4 sets of  $\frac{1}{10}$ , 5 sets of  $\frac{1}{100}$  and 6 sets of  $\frac{1}{1000}$ .



Ambai

$$2 = \square - \square$$

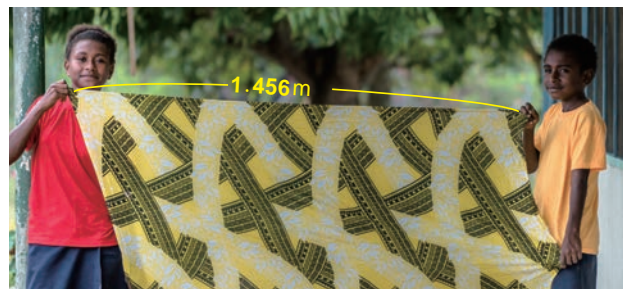

The length of the laplap (material) is 1.456 m.

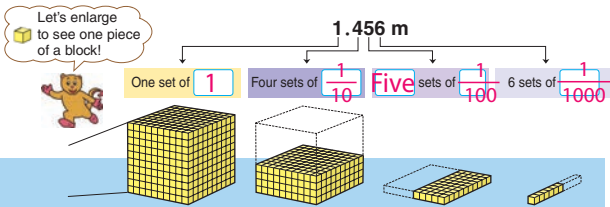

4 Write each number in the table below.

		Place Value Table						
		Thousands	Hundreds	Tens	Ones	Tenths	Hundredths	Thousandths
Altitude of Kundiawa		1	4	5	6			
Length of laplap					1	4	5	6

5 Compare the systems of decimal numbers and whole numbers and discuss what you have noticed with your friends.

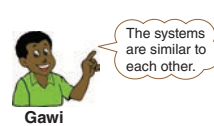

Gawi

The systems are similar to each other.

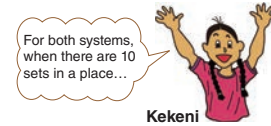

Keken

For both systems, when there are 10 sets in a place...

$$\square \div \square = 3$$

## Lesson Flow

### 1 1 Comparing two numbers 1456 and 1.456

- T** ▶ Ask students to compare the altitude of Kundiawa town and the length of the laplap. What do you notice about the two numbers?
- T** Introduce the Main Task. (Refer to the BP)
- S** 1 Fill in the boxes with sets of numbers for 1456 and 1.456
- T** 2 Look at the picture of the blocks and discuss what they notice.
- S** The structure of blocks for whole numbers and decimal numbers are similar.
- S** 3 Express each number by filling in the boxes.

### 2 Write the whole and decimal number in the place value chart.

- S** 4 Fill in the place value chart with numbers.
- The altitude of Kundiawa town.
  - The length of the laplap.

### 3 5 Discuss the system of whole and decimal numbers.

- T** From the place value chart in 4, compare and discuss what you have noticed with your friends.
- S** There are 10 sets in a place value therefore, the systems are similar.

### 4 2 Think about the system of whole number and decimal number.

- T** Ask students to think about the system of numbers and explain what they think.
- T/S** 1 For whole numbers;
- How many numbers are needed in a place for it to shift to the next higher place? (10)
  - How many equal parts must a number be divided for it to shift to the next lower place? (10 equal parts)
- T/S** 2 For decimal numbers;
- How many numbers are needed in a place for it to shift to the next higher place?(10)
  - How many equal parts must a number be divided for it to shift to the next lower place? (10 equal parts)

### 5 Important Point

- T/S** Explain the important point in the box  .

### 6 3 Investigate the two calculations.

- T** Ask the students to do a comparison of the two ideas in the calculation of whole number and decimal number. What do you think of Yamo's way of calculating?
- S** Explain their opinions to their friends.

### 7 Complete the Exercise

- S** Solve the selected exercises.
- T** Confirm students' answers.

### 8 Summary

- T** What have you learned in this lesson?
- S** Present ideas on what they have learned.
- T** Use students' ideas to confirm the important concepts of this lesson.

2 Let's think about the system of numbers.

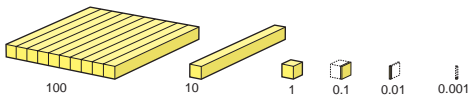

- 1 For whole numbers, how many numbers are needed in a place for it to shift to the next higher place? Also, how many equal parts must a number be divided for it to shift to the next lower place?
- 2 For decimal numbers, how many numbers are needed in a place for it to shift to the next higher place? Also, how many equal parts must a number be divided for it to shift to the next lower place? **10**      **10 equal parts**



For both whole and decimal numbers, a number is shifted to the next higher places when multiplied by 10 in every place and a number is shifted to the next lower places when it is divided by 10 (multiplied by  $\frac{1}{10}$ ). This is the basic idea of the place value system.

By using the place value system, any whole or decimal number can be expressed using the ten digits 0, 1, 2, ..., 9 and a decimal point.

3 Let's compare the calculations  $132 + 47$  and  $1.32 + 4.7$

$132 + 47$  is a calculation of whole numbers in vertical form as shown below.

$$\begin{array}{r} 132 \\ + 47 \\ \hline \end{array}$$

Similarly,  $1.32 + 4.7$  can be calculated in vertical form.

$$\begin{array}{r} 1.32 \\ + 4.7 \\ \hline \end{array}$$



I think, this calculation is wrong. Because...

What do you think of Yamo's way of calculating? Explain your opinions to your friends.



4 = □ - □

Page 5 of the textbook

#### Exercise

Let's make numbers using the ten digits from 0 to 9 once each time and a decimal point. **0.1**

Write the smallest number. Write a number that is smaller than 1 and is nearest to 1. **Ex 2. answer 0.9**

### Sample Blackboard Plan

Lesson 001 Sample Blackboard Plan is on page 7.

# Unit 1

## Unit: Decimal Numbers and Whole Numbers Sub-unit 1: The System of Decimal Numbers and Whole Numbers Lesson 2 of 3

Textbook Pages :  
005 and 006  
Actual Lesson 002

### Lesson Objective

- To find that when we multiply a number by 10, 100, the decimal point and number moves to the right side.

### Prior Knowledge

- The structure of decimal number and whole number.

### Preparation

- Diagram of stickers and place value chart on pages 5 and 6.
- Place value chart for activity 3

### Assessment

- Determine how the decimal point and number moves when multiplying a number by 10 or 100. **F**
- Solve the exercises correctly. **S**

### Teacher's Notes

The meaning of multiplying decimal numbers is given in the table in 3 where each digit in the decimal number moves and not the decimal point.

The technique in application to calculate decimal numbers is given in 5 where we assume that the decimal point moves.

#### Exercise

Let's make numbers using the ten digits from 0 to 9 once each time and a decimal point.  
Write the smallest number. Write a number that is smaller than 1 and is nearest to 1.

### How to move the decimal point when multiplying by 10 or 100.

#### 10 Times and 100 Times of a Number

4 Let's consider numbers multiplied by 10 and 100.

- 1 There are 10 stickers, each one is 1.34 cm wide and are lined up as shown below. How many centimetres (cm) is the total length?

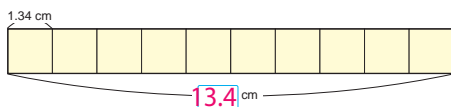

Just add ten of 1.34 together.

Kekeni



It's a lot of work to do repeated addition of 1.34 ten times.

Sare

#### Vavi's Idea

It is ten times of 1.34, so we can solve it by doing

$$\begin{array}{r} 1.34 \\ \times 10 \\ \hline 13.4 \end{array}$$

$$1.34 \times 10 = 13.4$$

- 2 There are 100 stickers, each one is 1.34 cm wide and are lined up. How many cm is the total length?

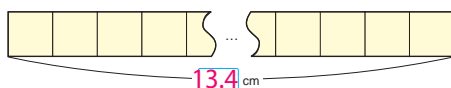

$$\square \div \square = 5$$

- 3 Write the total lengths when there are 10 stickers and 100 stickers in the table below.

	Hundreds	Tens	Ones	Tenths	Hundredths
times 10			1	3	4
10 times of 1.34			1	3	4
times 10			1	3	4
100 times of 1.34	1	3	4		

- 4 What rules are there?

- 5 Write in the decimal points when 1.34 is multiplied by 10 and 100.

$$\begin{array}{r} \times 10 \\ 1.34 \\ \hline 13.4 \\ \hline 134. \\ \hline \end{array}$$



If a number is multiplied by 10, the decimal point moves 1 place to the right.

If a number is multiplied by 100, the decimal point moves to 2 places to the right.

#### Exercise

Let's answer the following questions.

- 1 Write the numbers when 23.47 is multiplied by 10 and 100.  
234.7 and 2347
- 2 How many times of 8.72 are 87.2 and 872?  
10 times and 100 times

## Lesson Flow

**1** Review the previous lesson.

**2** **4** **1** Multiply 1.34 cm by 10.

**T** Introduce the Main Task. (Refer to the BP)

**T** Let's study numbers multiplied by 10.

**S** 10 stickers, each 1.34 cm in length are lined up as shown below.

**S** It's a lot of work to do addition of 1.34 ten times.

**T** How many centimetres is the total length?

**S** We can solve by multiplication using Vavi's idea.

**S**  $1.34 \times 10 = 13.4$

**3** **2** Multiply 1.34 cm by 100.

**T** Let's study numbers multiplied by 100.

**S** It's a lot of work to do addition of 1.34 hundred times.

**T** How many centimetres is the total length?

**S** We can solve by multiplication using Vavi's idea.

**S**  $1.34 \times 100 = 134$

**4** **3** When multiplying by 10 or 100, discuss what they notice and explain using the place value chart.

**T** Put up the place value chart and ask the students to fill in the blank spaces.

**S** Fill in the place value chart using Vavi's idea.

**T** **4** Study the place value chart and share any rules discovered.

**S** 1. When multiplying by 10 each digits in the number moves one place higher.

2. When multiplying by 100 each digits in the number moves two places higher

**T** **5** Write in the decimal points when 1.34 is multiplied by 10 and 100.

**S** 1. When multiplying by 10 the decimal point moves one place to the right.

2. When multiplying by 100 the decimal point moves two places to the right.

**5** Important Point

**T/S** Explain the important point in the box  

**6** Complete the Exercise

**S** Solve the selected exercises.

**T** Confirm students' answers.

**7** Summary

**T** What have you learned in this lesson?

**S** Present ideas on what they have learned.

**T** Use students' ideas to confirm the important concepts of this lesson.

## Sample Blackboard Plan

**Date:** Chapter: 1 Decimal Numbers and Whole Numbers. **Topic:** Multiplying decimal number by 10 and 100. **Lesson No:** 2/3

**Main Task:** Let's think about how to move the decimal point when multiplying by 10 and 100.

**Review**

**MT**

**4** Let's consider numbers multiplied by 10 and 100.

**1** There are 10 stickers, each one is 1.34cm wide, are lined as shown below. How many cm is the total length?

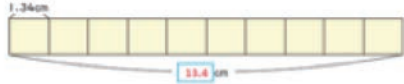

It is a lot of work to add ten of 1.34 or do repeated addition of 1.34 ten times.

$1.34 + 1.34 + 1.34 + 1.34 + 1.34 + 1.34 + 1.34 + 1.34 + 1.34 + 1.34$

Vavi's idea: It is ten times of 1.34, so we can solve it by doing

$$\begin{array}{r} 1.34 \\ \times 10 \\ \hline \end{array}$$

**2** There are 100 stickers, each one is 1.34 cm wide, are lined up. How many cm is the total length?



Using Vavi's idea.: It is 100 times of 1.34 so we can solve it by calculating  $1.34 \times 100 = 134$

**3** Write the total lengths when there are 10 stickers and 100 stickers in the table.

	Hundreds	Tens	Ones	$\frac{1}{10}$	$\frac{1}{100}$
times 10		1	3	4	
10 times of 1.34		1	3	4	
times 10		1	3	4	
100 times of 1.34	1	3	4		

**4** What rules are there?  
Write down students' responses.  
Answer: When multiplying by 10 each digits in the number moves one place higher and multiplying by 100 each digit in the number moves two places higher.

**5** Write in the decimal points when 1.34 is multiplied by 10 and 100.



**Important Point**

**Exercise**

(1) Write the numbers when 23.47 is multiplied by 10 and 100.

$23.47 \times 10 = 234.7$   
 $23.47 \times 100 = 2347$

(2) How many times of 8.72 are 87.2 and 872?  
10 times and 100 times.

**Summary**

The decimal point moves 1 place to the right when a number is multiplied by 10 and 2 places to the right when the number is multiplied by 100.

# Unit 1

## Unit: Decimal Numbers and Whole Numbers Sub-unit 1: The System of Decimal Numbers and Whole Numbers Lesson 3 of 3

Textbook Page :  
007  
Actual Lesson 003

### Lesson Objective

- Understand that when multiplying by  $\frac{1}{10}$  and  $\frac{1}{100}$ , the decimal point moves to the left side.

### Prior Knowledge

- How to move the decimal point when multiplying by  $\frac{1}{10}$  and  $\frac{1}{100}$ .

### Preparation

- Place value chart for ①
- Chart for ③

### Assessment

- Determine how the decimal point moves when multiplying a number by  $\frac{1}{10}$ ,  $\frac{1}{100}$ . **F**
- Solve the exercises correctly. **S**

### Teacher's Notes

For activity ① and ②, let students give their responses and write them down on the blackboard.

Later the teacher can confirm their responses.

### How to move the decimal point when multiplying by $\frac{1}{10}$ or $\frac{1}{100}$

#### $\frac{1}{10}$ and $\frac{1}{100}$ of a Number

⑤ Let's consider the numbers that are  $\frac{1}{10}$  and  $\frac{1}{100}$  of a number.

- ① Calculate  $\frac{1}{10}$  and  $\frac{1}{100}$  of 296 and write the answers in the table below.

	Hundreds	Tens	Ones	$\frac{1}{10}$	$\frac{1}{100}$
$\frac{1}{10}$ of 296 $\rightarrow \frac{1}{10}$	2	9	6		
$\frac{1}{100}$ of 296 $\rightarrow \frac{1}{100}$					

$\frac{1}{10}$  of 296 is as follows:  
 $\frac{1}{10}$  of 200 is 20  
 $\frac{1}{10}$  of 90 is 9  
 $\frac{1}{10}$  of 6 is 0.6  
 $20 + 9 + 0.6 = 29.6$   
 then,  $\frac{1}{10}$  of 296 is 29.6

When multiplying by  $\frac{1}{10}$ , digits move one place to the left.

- ② What rules are there?  
 ③ Write the decimal points of numbers that are  $\frac{1}{10}$  and  $\frac{1}{100}$  of 296 in the  below.

	2	9	6		
$\frac{1}{10}$	2	9	6		
$\frac{1}{100}$	2	9	6		



- $\frac{1}{10}$  of a number moves the decimal point 1 place to the left.  
 $\frac{1}{100}$  of a number moves the decimal point 2 places to the left.

#### Exercise

Let's answer the following questions.

- ① Write the numbers that are  $\frac{1}{10}$  and  $\frac{1}{100}$  of 30.84 **3.084 and 0.3084**  
 ② What are 6.32 and 0.632 as a multiple of 63.2?

$$\frac{1}{10} \quad \frac{1}{100}$$

$$\square \div \square = 7$$

## Lesson Flow

### 1 Review the previous lesson.

**T** Introduce the Main Task. (Refer to the BP)

### 2 **5** Considering the numbers that are $\frac{1}{10}$ and $\frac{1}{100}$ of 296.

**T** **1** Ask students to fill in the place value chart using the hint from the Kapul.

**S** Fill in the place value chart with the answers for  $\frac{1}{10}$  of 296 and  $\frac{1}{100}$  of 296.

**T** **2** From the place value chart in **1**, what rules have you discovered?

- S**
1. When multiplying by  $\frac{1}{10}$  each digit in the number moves one place lower than 1.
  2. When multiplying by  $\frac{1}{100}$  each digit in the number moves two places lower than 1.

**T** **3** Write in the decimal points of numbers that are  $\frac{1}{10}$  and  $\frac{1}{100}$  of 296 in the .

- S**
1. When multiplying by  $\frac{1}{10}$  the decimal point moves one place to the left.
  2. When multiplying by  $\frac{1}{100}$  the decimal point moves two places to the left.

### 3 Important Point

**T/S** Explain the important point in the box  

### 4 Complete the Exercise

**S** Solve the selected exercises.

**T** Confirm students' answers.

### 5 Summary

**T** What have you learned in this lesson?

**S** Present ideas on what they have learned.

**T** Use students' ideas to confirm the important concepts of this lesson.

## Sample Blackboard Plan (Lesson 1)

**Date:**      **Chapter:** 1 Decimal Numbers and Whole Numbers.      **Topic:** Structure of the whole and decimal numbers.      **Lesson No:** 1/3

Main Task: Let's think about how to compare the systems of whole numbers and decimal numbers.

**Let's think about the system of numbers.**



**10 equal parts.**  
**10 equal parts.**

**Important Point**

**1** Write each number in the table below.

	Thousands	Hundreds	Tens	Ones	Tenths	Hundredths	Thousandths
Altitude of Kundliawa	1	4	5	6	.		
Length of laplap.				1	.	4	5
						.	6

**2** Let's compare the two numbers 1456 and 1.456

Activity **1** and **2**

The altitude of Kundliawa Town is 1 456 m.



**3** Express each number by expression.

$1\ 456 = 1\ 000 + 400 + 50 + 6$   
 $= 1\ 000 \times \square + 100 \times \square + 10 \times \square + 1 \times \square$

$1.456 = 1 + 0.4 + 0.05 + 0.006$   
 $= 1 \times \square + 0.1 \times \square + 0.01 \times \square + 0.001 \times \square$

The length of the laplap with designs is 1.456 m.



**4** Compare and discuss the systems of the whole numbers and decimal numbers.

**3** Let's compare the calculations  $132 + 47$  and  $1.32 + 4.7$

$$\begin{array}{r} 132 \\ +47 \\ \hline 179 \end{array}$$

$$\begin{array}{r} 1.32 \\ +4.7 \\ \hline 6.02 \end{array}$$

3 sets of , 2 sets of , 7 sets of

**Exercise**

Let's make numbers using the ten digits from 0 to 9 once each time and a decimal point. Write the smallest number. **0.1**

**Summary**

- The structure of the whole numbers shift to the next higher place when multiplied by 10.
- The structure of the whole numbers shift to the next lower place when multiplied by 1/10.

## Sample Blackboard Plan (Lesson 3)

**Date:**      **Chapter:** 1 Decimal Numbers and Whole Numbers.      **Topic:** Multiplying decimal number by  $\frac{1}{10}$  and  $\frac{1}{100}$       **Lesson No:** 3/3

Main Task: Let's think about how to move the decimal point when multiplying by  $\frac{1}{10}$  and  $\frac{1}{100}$

**Review**

**MT**

**1** Let's consider the numbers that are and

**2** Calculate and 296 and write the answers in the table.

	Tens	Ones	$\frac{1}{10}$	$\frac{1}{100}$
$\frac{1}{10}$ of 296	2	9	6	
$\frac{1}{100}$ of 296	2	9	6	

**3** Write down students responses.

Answer: When multiplying by each digits in the number moves one place lower and when multiplying by each digits in the number moves two places lower.

**4** Write down the decimal points of the numbers that are and of 296 in the

$$\begin{array}{r} 296 \\ \frac{1}{10} \\ \hline 29.6 \\ \frac{1}{100} \\ \hline 2.96 \end{array}$$

**Important Point**

**Exercise**

(1) Write the numbers that are and of 30.84  
3.084 and 0.3084

(2) What are 6.32 and 0.632 as a multiple of 63.2?  
By and respectively.

**Summary**

The decimal point moves 1 place to the left when a number is multiplied by  $\frac{1}{10}$  and 2 places to the left when the number is multiplied by  $\frac{1}{100}$ .

# Unit 1

## Unit: Decimal Numbers and Whole Numbers Exercise, Problems and Evaluation Lesson 1 and 2 of 2

Textbook Pages :  
008 and 009  
Actual Lesson 004 and 005

### Lesson Objective

- To confirm their understanding on the concepts they learned in this unit by completing the Exercise, Problems 1, Problems 2 and the Evaluation Test confidently.

### Prior Knowledge

- All the contents covered in this unit

### Preparation

- Evaluation test copy for each student

### Assessment

- Complete the Exercise and Problems 1 and 2 correctly. **S**

### Teacher's Notes

This is the last lesson of Chapter 1. Students should be encouraged to use the necessary skills learned in this unit to complete all the Exercises and solve the Problems in preparation for the evaluation test. The test can be conducted as assesment for your class after completing all the exercises. Use the attached evaluation test to conduct assesment for your class after finishing all the exercises and problems as a seperate lesson.

### EXERCISE

#### Structure of decimal numbers and whole numbers

- Let's fill the  with numbers.
  - $86.1 = 100 \times 8 + 10 \times 6 + 1 \times 1$
  - $0.0072 = \frac{1}{1000} \times 7 + \frac{1}{10000} \times 2$
- Let's summarise the common features with both decimal numbers and whole numbers.
  - For both whole numbers and decimal numbers, when there are **10** sets of a number, it is shifted one place higher. When a number is divided into **10** parts, it is shifted one place lower. Whole and decimal numbers are both, based on the place value system.
  - Any whole or decimal number can be expressed by using the **ten** digits from 0 to 9 and a decimal point.
  - Let's write numbers that are 10 times and 100 times of 36.05 and numbers that are  $\frac{1}{10}$  and  $\frac{1}{100}$  of 36.05.

#### Find numbers when multiplying by 10, 100, $\frac{1}{10}$ and $\frac{1}{100}$

Summarise what you have learned on your exercise book.

1. Decimal numbers and whole numbers

(1) What I understood.

For both whole numbers and decimal numbers, when there are 10 sets of a number, it is shifted to the next higher place value.

(2) Some interesting facts.

A number that is 10 times or  $\frac{1}{10}$  of a number can be made by moving a decimal point.

10 times 1.34 is 13.4 and  $\frac{1}{10}$  of 1.34 is 0.134

$8 = \square - \square$

### PROBLEMS 1

- Express the following quantities by using the units written in the ( ).
  - 8695 ~~1000~~ <sup>1000 times</sup> 8695 kg
  - 320 mL (L)
  - 3.67 km (m)
  - 67.2 m (cm)
- Let's answer the following questions.
  - Times 0.825 by 10 **8.25**
  - Times 5.67 by 100 **567**
  - $\frac{1}{10}$  of 72.3 **7.23**
  - $\frac{1}{100}$  of 45.2 **0.452**
- Let's find given numbers.
  - When a given number was multiplied by 10 and further multiplied by 100, it became 307.4 **0.3074**
  - When a given number was multiplied by 100 and further divided by  $\frac{1}{10}$ , it became 20.5 **2.05**
  - When a given number was divided by  $\frac{1}{100}$  and further divided by  $\frac{1}{100}$ , it became 0.175 **175**

### PROBLEMS 2

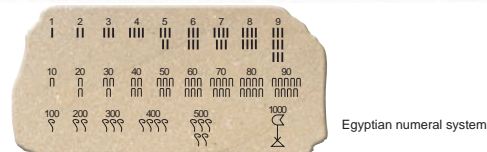

- When 176 is expressed in Egyptian numerals, it is as written below.
  - Write  $\text{𐤀} \text{𐤁} \text{𐤂} \text{𐤃}$  as a whole number.
  - Let's compare the way of Egyptian numeral to the way you have learned to express numbers and write them down.
  - Let's calculate  $\frac{176}{244}$  in Egyptian numerals.

$\square \div \square = 9$



## Lesson Flow

### 1 ① Let's fill in the box with numbers.

- T Ask students to complete activity ① and ② on the board.
- S Write their answers on the board, other students confirm.

### 2 Complete Exercise ② and ③

- T Ask students to work individually to complete task 2 and 3.
- S Work individually to complete task then share their ideas with their friends.
- T Confirm answers with students

### 3 Solve the Problems 1

- S Solve all the problems.
- T Confirm students' answers.

### 3 Solve the Problems 2

- S Solve all the problems.
- T Confirm students' answers.
- TN Collect students' books for marking if time does not allow.

### 4 Complete the Evaluation Test

- TN Use the attached evaluation test to conduct assesment for your class after finishing all the exercises and problems as a seperate lesson.
- S Complete the Evaluation Test.

End of Chapter Test:	Date:	
Chapter 1: Decimal Numbers and Whole Numbers	Name:	Score / 100
[10 x 10 marks = 100 marks]		
1. Fill words or numbers in the <input type="checkbox"/> below.		
(1) The 7 in 3.57 is on the place value of <input type="checkbox"/> .	Answer:	Hundredths
(2) The number of 10 times 0.24 is <input type="checkbox"/> .	Answer:	2.4
2. Fill in numbers in each <input type="checkbox"/> .		
(1) $4651 = \boxed{4} \times 1000 + \boxed{6} \times 100 + \boxed{5} \times 10 + \boxed{1} \times 1$		
(2) $2.174 = 2 \times \boxed{1} + 1 \times \boxed{0.1} + 7 \times \boxed{0.07} + 4 \times \boxed{0.001}$		
3. Find the numbers.		
(1) 10 times 0.618	(2) 100 times 10.25	(3) $\frac{1}{10}$ of 70.3
Answer: <span style="border: 1px solid black; padding: 2px;">6.18</span>	Answer: <span style="border: 1px solid black; padding: 2px;">1025</span>	Answer: <span style="border: 1px solid black; padding: 2px;">7.03</span>
4. You make a decimal number by inserting one digit number in <input type="checkbox"/> of 5.6 <input type="checkbox"/> 7.		
(1) What is the biggest decimal number?	Answer:	5.697
(2) What is the smallest decimal number?	Answer:	5.607
(3) Select all numbers which are greater than 5.66 from the numbers below. 5.687 , 5.637 , 5.60		
		Answer: <span style="border: 1px solid black; padding: 2px;">5.687</span>

**End of Chapter Test****Date:**

Chapter 1: Decimal Numbers and Whole Numbers	Name:	Score / 100
---	-------	----------------

[10 × 10 marks = 100 marks]

1. Fill in the words or numbers in the  below.(1) The 7 in 3.57 is on the place value of .

Answer:

(2) The number of 10 times 0.24 is .

Answer:

2. Fill in the numbers in each .

(1)  $4651 = \square \times 1000 + \square \times 100 + \square \times 10 + \square \times 1$

(2)  $2.174 = 2 \times \square + 1 \times \square + 7 \times \square + 4 \times \square$

3. Find the numbers.

(1) 10 times 0.618

Answer:

(2) 100 times 10.25

Answer:

(3)  $\frac{1}{10}$  of 70.3

Answer:

4. You make a decimal number by inserting one digit number in the  of 5.6  7.

(1) What is the biggest decimal number?

Answer:

(2) What is the smallest decimal number?

Answer:

(3) Select all the numbers which are greater than 5.66 from the numbers below.

5.687 , 5.637 , 5.60

Answer:

# Chapter 2 Amount per Unit Quantity

## 1. Content Standard

5.4.1 Explore proportions in two changing quantities and explain the patterns by using the relation of direct proportionality.

## 2. Unit Objectives

- To understand how to express mean through working with quantity per unit.
- To think about the amount based on measurement of per unit quantity.

## 3. Teaching Overview

### Mean :

Students are given actual situation that require leveling off data such as number of laps run by students for them to understand the concept of averaging.

The action of averaging is a way of finding ideal situations such as “what if everybody ran the same number of laps?” or “what if every cup holds the same amount of water?”

They deal with both discrete quantities for example something countable such as number of people or fruits, and continuous quantities such as lengths, volume, weight etc.

Discrete quantities were easy for students to understand in the previous grades and continuous quantities were not since they had to think of uncountable quantities such as some amount between 1 and 2 litres.

However, it will be rather difficult for students to think about the mean of discrete quantities in this unit than the mean of continuous quantities.

For instance, the mean of water in 3 containers can be expressed in a decimal value.

However, the mean of the number of bananas held by 3 children can be expressed as a decimal value like 2.4 bananas which is not realistic. Students should understand that mean can be expressed in decimal or fraction even though the objects are countable.

### Amount per Unit Quantity :

This is a difficult concept for students since the measurement is called synthetic quantity. In the case of comparing degrees of congestions with different number of people within different areas, they need to make ideal situations such as “same area, different number of people” or “different areas, same number of people”

Finally, they will find out the formula, number of people ÷ area.

## 4. Related Learning Contents

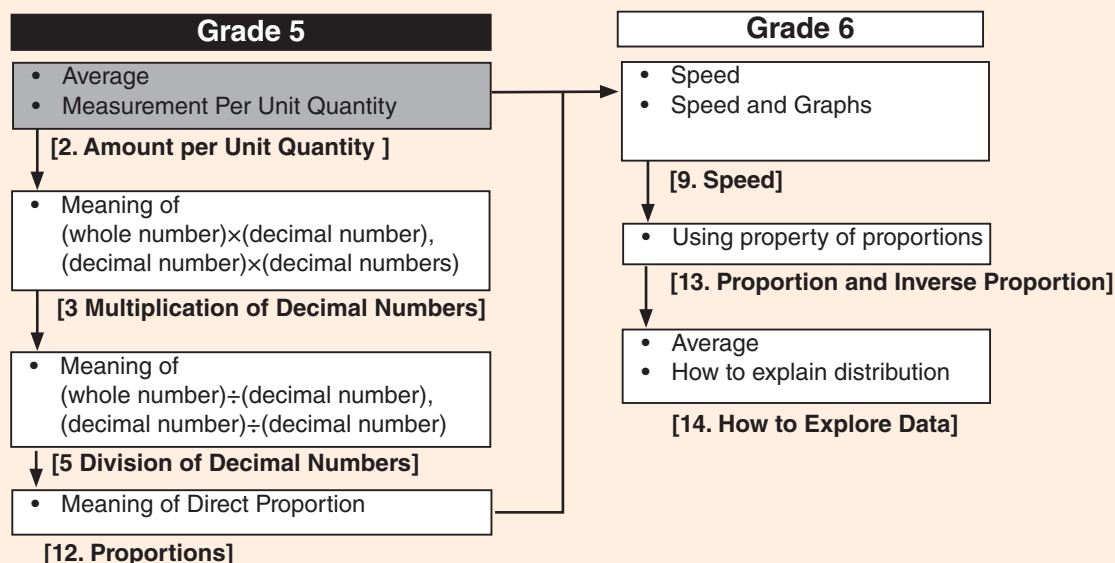

# Unit 2

## Unit: Amount per Unit Quantity Sub-unit 1: Mean Lesson 1 of 3

Textbook Pages :  
010 to 012  
Actual Lesson 006

### Sub-unit Objectives

- To define the meaning of mean and how to use it.
- To find mean from various quantities.

### Lesson objective

- To understand how to balance a quantity.

### Prior Knowledge

- Bar Graph
- Paper Blocks

### Preparation

- Table and Bar Graphs to be placed on the blackboard
- Grid papers to draw bar graph (Students can copy the graphs from the textbook)

### Assessment

- Apply the idea of balancing to compare two quantities. **F**
- Explain averaging. **S**

### Teacher's Notes

- In this lesson, we can balance the laps run by Sam and Yapi. When preparing graphs, make the squares for balancing be movable so it will be easy to show the idea of averaging when balancing.
- Key Phrases
  - 1) Sam ran 5 days making 40 laps
  - 2) Yapi ran 4 days making 36 laps
- The following are important mathematical terms that can be used in their discussions, **If and Then.**

## 2

### Amount per Unit Quantity



- ▶ Every child in the classroom trained for the school carnival. They ran around the field after class. Sam and Yapi made tables of the number of laps they ran around the field last week.
- ▶ Sam trained for all 5 days and Yapi was sick on Friday so he ran for 4 days only.

Number of Laps Sam Ran						
Days	Mon	Tue	Wed	Thu	Fri	Total
Number of laps	9	7	11	6	7	40

Number of Laps Yapi Ran					
Days	Mon	Tue	Wed	Thu	Total
Number of laps	10	8	6	12	36

$10 = \square + \square$



- ▶ Who is more prepared for the sports carnival?  
Is it Sam or Yapi?



If you look at the total, Sam ran more.

Naiko

But can we compare by the total laps if the number of days are different?



Kekeni



If Yapi was not sick on Friday, how many laps would he have done?

Yamo

If Yapi ran 4 laps on the absent day, then the total would have been 40 laps, which is the same as Sam's total.



Sare

Ph <sup>ra</sup> se

"If ~, then ~."

These terms are used when something is assumed or estimated. They are often used in mathematics when the conditions are changed to get the conclusion.

$\square \times \square = 11$

## Lesson Flow

### 1 Think about the laps run by two children.

- T** Ask the students to look at the pictures and have pre-discussion.
- S** Do pre-discussions using the pictures.
- T/S** ▶▶ Read and understand the situation and use the table to discuss.
- T** ① What can you interpret from the two tables?
- S** Possible responses.  
Sam trained for 5 days and made 40 laps.  
Yapi was sick on Friday so he ran for 4 days and made 36 laps.
- T** ▶▶ Who is more prepared for the sports carnival? Is it Sam or Yapi?
- T/S** Discuss the hints from the four friends and estimate which child is more prepared.
- TN** • If two students run the same number of days then we can compare.  
• If they run the same laps then we can compare.
- T** Introduce the Main Task. (Refer to the BP)

- T** ① How can we make the number of laps the same every day? 
- T/S** Discuss and understand that we can easily compare when we have total number of laps (40) and same number of laps per day.
- TN** Bring some of the laps from the larger number of laps to smaller number.
- S** Manipulate the paper blocks to balance the graph.
- S** Draw bar graph to balance the graph for Sam.
- T** How many laps did Sam run each day?
- S** 8 laps per day.
- T** ② How can we make the number of laps the same every day?
- T/S** Discuss and understand that we can easily compare when we have total number of laps (36) and same number of laps per day.
- TN** Bring some of the laps from the larger number of laps to smaller number.
- S** Use the graph and manipulate with the blocks.
- S** Draw bar graph to balance the graph for Yapi.
- T** How many laps did Yapi run each day?
- S** 9 laps per day.

### 2 Understanding the meaning of averaging.

- T/S** ① Read and understand the situation.

#### ① Mean

- ① If Sam and Yapi ran the same number of laps every day, how many laps would it be per day?  
*To understand how to balance a quantity*  
*8 laps for Sam 9 laps for Yapi*
- ① Sam ran the same total number of laps as last week, how many laps would he have run per day if he ran the same number of laps everyday?

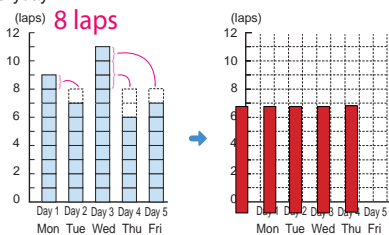

- ② Yapi ran the same total number of laps as last week, how many laps would he have run per day if he ran the same number of laps everyday? *9 laps*

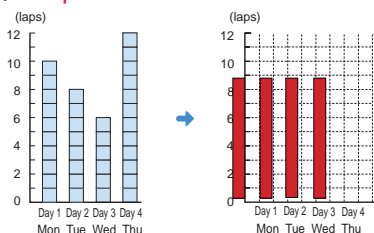

- ③ Which of them trained more? *Yapi*



The process of making different sized measurements to the new measure evenly or equally is called **averaging**.

12 = □ + □

### 3 Comparing their efforts, who trained more?

- T** ③ Which child trained more?
- S** Yapi
- T** Why do you say Yapi?
- S** After balancing we realise that Yapi ran more with a total of 9 laps each day.

### 4 Important Point

- T/S** Explain the important point in the box

### 5 Summary

- T** What have you learned in this lesson?
- S** Present ideas on what they have learned.
- T** Use students' ideas to confirm the important concepts of this lesson.

### Sample Black Board Plan

Lesson 006 Sample Blackboard Plan is on page 15.

**Lesson Objective**

- To think about how to find the mean of some numbers or quantities.

**Prior Knowledge**

- Introduction to averaging

**Preparation**

- Diagram of juice representation
- Diagram of Kekeni's and Mero's ideas

**Assessment**

- Think about how to find the mean measure. **F**
- Define mean and explain how to find mean. **S**

**Teacher's Notes**

- The definition of mean can be explained well using Mero's idea. Teacher use Mero's idea to explain mean. Pour all the juice together (4 + 2 + 1 + 5) and then divide the juice among 4 containers.
- Notice that when calculating the mean, brackets are used, so apply BODMAS in the calculation.
- Average is the process of making different sized measures to new measure evenly or equally.
- Mean is the same number of measure which is averaged from some numbers or measures.
- The concept of averaging is used in everyday life therefore, it is important for students to understand how averaging is done in this lesson.

**To understand the meaning of 'mean'**

- 2 There are some juice in the containers on the right.
- 1 Let's average them so that each container has the same amount of juice.

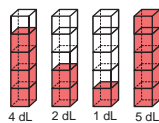

**Kekeni's Idea**

Move from larger to smaller amounts of juice.

**Mero's Idea**

Pour all the juice together and then divide the juice among the containers.

**Understand how to calculate 'mean'**

- 2 Think about how to calculate the averaged measure.

$$(4 + 2 + 1 + 5) \div 4 = 3$$

Total juice in 4 containers    Number of containers    Averaged juice per container

To average the measure for 4 containers, we divide the total amount of juice equally in all containers by the number of containers.

The same number or measure which is averaged from some numbers or measures is called **mean** of the original numbers or measures.

**Mean = total ÷ number of items**

$\square \times \square = 13$

## Lesson Flow

**1** Review the previous lesson.

**T** Make emphasis on Kekeni's and Mero's ideas.

**2** Think about how to balance the amount of juice with various dL.

**3** **2** Discuss how to calculate the mean.

**T/S** **2** Read and understand the situation.

**T** Can we express how to find the mean in a mathematical sentence?

**T** Ask students to observe the chart and think about ways to balance.

**S** Yes, by using Mero's idea, the mathematical sentence can be written as  $(4 + 2 + 1 + 5) \div 4 = 3$

**S** Think of ways on how to balance the amounts of juice and present their ideas.

**4** Important Point

**T** Introduce the Main Task. (Refer to the BP)

**T/S** Explain the important point in the box  

**T** **1** Let's average them so that each container has the same amount of juice.

**5** Summary

**TN** Let students to observe Kekeni's and Mero's ideas while the teacher explains.

**T** What have you learned in this lesson?

**S** Briefly explain Kekeni's and Mero's ideas to make conclusions on how to calculate the mean.

**S** Present ideas on what they have learned.

**T** Use students' ideas to confirm the important concepts of this lesson.

### Sample Blackboard Plan (Lesson 6)

**Date:** \_\_\_\_\_  
**Chapter:** 2 Amount per Unit Quantity.  
**Topic:** Mean **Lesson No:** 1/3

**MT: Let's think about how to balance a quantity using laps run by two children.**

►► Pre-discussion and students' responses using the pictures and the tables.

Days	Mon	Tue	Wed	Thu	Fri	Total
No. of laps	9	7	11	6	7	40

Days	Mon	Tue	Wed	Thu	Total
No. of laps	10	8	6	12	36

**MT: Introduce the main task here.**

[1] If Sam and Yapi had run the same number of laps every day, how many laps would it be per day?

● Sam ran the same total number of laps as last week, how many laps would he have run per day if he ran the same number of laps everyday? **8 laps**

● Yapi ran the same total number of laps as last week, how many laps would he have run per day if he ran the same number of laps everyday? **9 laps**

● Which of them trained more? **Yapi because after balancing it is obvious he ran more with a total of 9 laps each day.**

**Important Point.**

**Summary**

\*To balance a quantity per unit, level all the data from the total quantity.

### Sample Blackboard Plan (Lesson 7)

**Date:** \_\_\_\_\_  
**Chapter:** 2 Amount per Unit Quantity.  
**Topic:** Mean **Lesson No:** 2/3

**MT: Let's think about how to average measure.**

**Review**

[2] There are some juice in the containers on the right.

● Let's average them so that each container has the same amount of juice.

Write down students ideas using ideas from the previous lesson.

**MT: Introduce the main task here.**

**IDEAS IN THE TEXT BOOK.**

**KEKENI'S IDEA:** Move from larger to smaller amounts of juice.

**MERO'S IDEA:** Pour all the juice together and then divide the juice among the containers.

● Think about how to calculate the averaged measure.

$$(4 + 2 + 1 + 5) \div 4 = 3$$

Total juice in 4 containers.      Number of containers.      Averaged juice per container.

To average the measure for 4 containers, we divide the total amount of juice equally in all containers by the number of containers.

**Important Point.**

**Summary**

To find the mean of numbers or quantities:

\* We move from larger to smaller amounts of quantity (juice) to make it even.

\* We total the amounts (juice) and then divide by the total number of items (containers).

Mean = total ÷ number of items.

**Lesson Objectives**

- To understand that mean can be used to express measurement which cannot be averaged in reality.
- To understand that mean can be expressed in decimal numbers.

**Prior Knowledge**

- Averaging
- Definition of mean

**Preparation**

- Diagram representation 3
- Table for 4

**Assessment**

- Understand and explain that mean is applicable for measurements which cannot be averaged in reality. **F**
- Calculate mean for measurements which cannot be averaged in reality. **S**

**Teacher's Notes**

- Lesson Objective one refers to discrete quantity.
- The mean can be expressed in decimal when we are comparing two or more quantities.
- Calculators can be used to calculate the mean in this lesson.
- For task 4, explain the use of zero (the number of books Ken read) in the equation of mean that it is included in the 'number of items'.
- The answer in task 4 as 2.8 can be said as almost 3.

**Calculating 'mean' to express measurement that cannot be averaged in reality**

- 3 There were 2 chickens, one laid brown and the other laid white eggs. The weights are shown below.  
Which of the eggs are heavier? Compare by calculating the mean weight of their eggs.

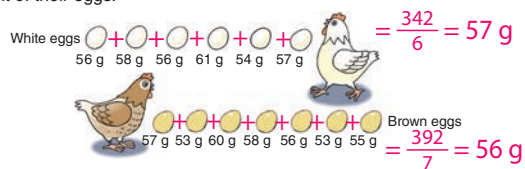

Even for things that cannot be averaged in real life, if the number and amount is known, the mean can be calculated.

**Understanding the expression of 'mean' as a decimal number**

- 4 The table below shows the number of books 5 students read in August. What is the mean number of books read by the 5 students? **2.8**

Number of Books Read					
Name	Boni	Yata	Ken	Sawa	Yaling
Number of books read	4	3	0	5	2

$= \frac{14}{5} = 2.8$

Even for things that are impossible to be expressed in decimal numbers, like number of books, the mean can be expressed in decimal numbers.



## Lesson Flow

**1** Review the previous lesson.

**2** Calculating mean to express measurement that cannot be averaged in reality.

**T** Introduce the Main Task. (Refer to the blackboard plan)

**T/S** **3** Read and understand the situation.

**T** Compare by calculating the mean weight of white eggs and mean weight of yellow eggs.

**S** Compare the weight by calculating mean using: Mean = total ÷ number of items

**S** White eggs  $56 + 58 + 56 + 61 + 54 + 57 = 342 \div 6 = 57$  answer : 57 g

Brown eggs  $57 + 53 + 60 + 58 + 56 + 53 + 55 = 392 \div 7 = 56$  answer : 56 g

Therefore, white eggs are heavier.

**T** Confirm answers with students'

**3** Important Point

**T/S** Explain the important point in the box  .

**4** Understanding the expression of mean as a decimal number.

**T/S** **4** Read and understand the situation.

**T** Study the table given in **4** and calculate the mean number of books read by 5 students.

**S** Use Mean = total ÷ number of items,  $4 + 3 + 0 + 5 + 2 = 14 \div 5 = 2.8$

**TN** Through the process of calculating, realise that the answer is between 2 – 3 books. Book cannot be divided though we can still use mean.

**5** Important Point

**T/S** Explain the important point in the box  .

**6** Summary

**T** What have you learned in this lesson?

**S** Present ideas on what they have learned.

**T** Use students' ideas to confirm the important concepts of this lesson.

### Sample Blackboard Plan

**Date:**  
**Chapter:** 2 Amount per Unit Quantity.  
**Topic:** Mean                      **Lesson No:** 3/3

**MT:** Let's think about how to average things in real life situations.

**Review**  
**MT:** Introduce the main task here.

[3] 2 chickens laid white and brown eggs. Which of the eggs are heavier? Compare by calculating the mean weight of their eggs.

white eggs: = 342 = 57g  
56 g 58 g 56 g 61 g 54 g 57 g

Brown eggs: = 392 = 56g  
57 g 53 g 60 g 58 g 56 g 53 g 55 g

The white eggs are heavier.

**Important Point.**

[4] The table shows the number of books 5 students in Boni's group read in August. What is the mean number of books read by the 5 students?

Number of Books Read.

Name	Boni	Yata	Ken	Sawa	Yaling
Number of books read.	4	3	0	5	2

What is the mean number of books read by 5 students?  
 $4 + 3 + 0 + 5 + 2 = 14 \div 5 = 2.8$

We cannot say 2.8 books read, however we can say 2 to 3 books were read by each student.

**Important Point.**

**Summary**

\* Mean can be calculated even if they cannot be averaged in real life situation.  
 \* Mean can be expressed in decimal numbers.

# Unit 2

## Unit: Amount per Unit Quantity Sub-unit 2: Amount per Unit Quantity Lesson 1 of 5

Textbook Page :  
015 and 016  
Actual Lesson 009

### Sub-unit Objectives

- To recognise the relationships between multiplicands, multipliers and products based on the features of multiplication table and identify rules and patterns.
- To understand cumulative law of multiplication.

### Lesson Objectives

- To understand that when comparing the crowd, the size of area and number of people are related.
- To understand that we can compare the quantity per area when we adjust number of people or area.

### Prior Knowledge

- Averaging quantity
- Calculating mean

### Preparation

- Task 1 information for (A), (B) and (C)
- Chart with blank Table for 1 and 2

### Assessment

- Think about and explain how to compare crowdedness using pictures. **F**
- Compare using same measure; number of students and area. **S**

### Teacher's Notes

To find the quantity per unit, we need to find the total quantity and divide. In the example of textbook page 15, we find the average number of students for a mat. This is the first time for students to learn measurement per unit, followed by population density (people/km<sup>2</sup>), speed (km/h) etc. Take enough time in the introduction or conclusion for students to understand this idea otherwise students might be left behind. In this case they should think and find the crowdedness with 2 quantities: number of students and number of mats.

## 2 Amount per Unit Quantity

- 1 Students are standing on the mats. Each mat is of the same size. Which one of (A), (B) and (C) is more crowded?
- (A) 2 mats, 12 students.  
(B) 3 mats, 12 students.  
(C) 3 mats, 15 students.

(A) 2 mats, 12 students.



(B) 3 mats, 12 students.



(C) 3 mats, 15 students.



Let's think about how to compare crowdedness.

$$\square \times \square = 15$$

$$16 = \square + \square$$

- 1 Let's compare which one is more crowded?

	Number of mats	Number of students
(A)	2	12
(B)	3	12
(C)	3	15

(A) or (B) → (A)

When the number of students are the same, the one with **Less** mats is more crowded.

(B) or (C) → (C)

When the number of mats are the same, the one with **More** students is more crowded.

Compare (A) or (C) → (A)



Both the number of mats and students are different.

If we make the number of mats equal...



- 2 Let's find out how many students are on each of the mats. To understand cumulative law of multiplication.

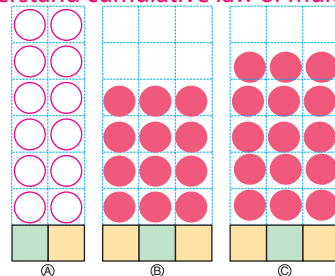

## Lesson Flow

### 1 Review the previous lesson.

### 2 Discuss the pictures (A), (B) and (C) and identify which is more crowded.

**T/S** 1 Read and understand the situation.

**T** Allow students to discuss and compare the crowdedness in (A), (B) and (C).

**S** Possible responses;

(A) 2 mats with 12 students is very crowded.

(B) 3 mats with 12 students is less crowded.

(C) 3 mats with 15 students is very crowded.

**TN** Confirm the answer in 2.

**T** Introduce the Main Task. (Refer to the BP)

### 3 Think about how to compare the crowdedness of students.

**TN** Refer to the table to compare.

**T** 1 Compare (A) and (B), which is more crowded and why?

**S** (A) is more crowded. When the number of students are the same the one with less mats is more crowded.

**T** Compare (B) and (C), which is more crowded and why?

**S** (C) is more crowded. When the number of mats are same, the mat with more students is more crowded.

**T** Compare (A) and (C), which is more crowded and why?

**S** It is difficult to compare because both number of students and mats are different.

### 4 Find out the crowdedness of (A) and (C) using the unit idea.

**T** 2 Find out how many students are on each mat.

**TN** Draw circles in each square as shown for (A) and complete for (B) and (C) to compare (A) and (C).

**S** (A) is more crowded because 6 students can share one mat whereas in (C) 5 students can share one mat.

### 5 Summary

**T** What have you learned in this lesson?

**S** Present ideas on what they have learned.

**T** Use students' ideas to confirm the important concepts of this lesson.

## Sample Blackboard Plan

**Date:**  
**Chapter:** 2 Amount per Unit Quantity.  
**Topic:** Measurement per Unit Quantity. **Lesson No:** 1/5

**MT: Let's think about how to compare the crowdedness.**

**Review**

[1] Children are standing on mats. Which one of A, B and C is more crowded?

A. 2 mats 12 children  
 B. 3 mats 12 children  
 C. 3 mats 15 children

} Observe the pictures, discuss and describe the crowdedness using the text book.

**MT: Introduce the main task here.**

● Which is more crowded?

	Mat	No. of Children.
A	2	12
B	3	12
C	3	15

Compare A or B → **A**

When the number of children are the same, the one with less mats is more crowded.

Compare B or C → **C**

When the number of mats are the same, the one with more children is more crowded.

Compare A or C → **A**

● Let's find out how many children are on each of the mats.

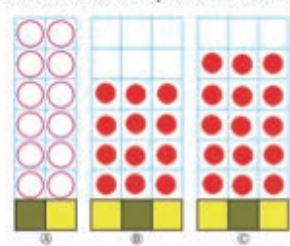

**A:** 6 children per mat.  
**B:** 4 children per mat.  
**C:** 5 children per mat.

**Summary**

\* When comparing the number of students in a given area, we understand that the crowdedness of people and size of area are related.

\* We can then say the number of people per area is the amount per unit quantity.

# Unit 2

## Unit: Amount per Unit Quantity Sub-unit 2: Amount per Unit Quantity Lesson 2 of 5

Textbook Page :  
017  
Actual Lesson 010

### Lesson Objective

- To understand how to compare the crowdedness by using amount per unit quantity.

### Prior Knowledge

- Averaging quantity
- Calculating mean

### Preparation

- Chart of the important point

### Assessment

- Compare the crowdedness through calculation using same unit. **F**
- Solve the exercises correctly. **S**

### Teacher's Notes

- We introduce the unit of area in this lesson. The students should understand that the level of crowding can be measured by number of people per 1 m<sup>2</sup> or per 1 km<sup>2</sup>.
- A** and **B** - same number of students, different number of mats.
- B** and **C** - same number of mats different number of students.
- A** and **C** - different number of mats and students.

### Understand how to compare crowding using per unit quantity

3 The area of 1 mat is 1 m<sup>2</sup>.

How many students are there in per 1 m<sup>2</sup> ?

**A**  $12 \div 2 = 6$

**B**  $12 \div 3 = 4$

**C**  $15 \div 3 = 5$

Number of students

Area (m<sup>2</sup>)

Number of students per 1 m<sup>2</sup>



The level of crowding is expressed by 2 measures, the number of students and the area.

Usually we compare the level of crowding by using the same unit, such as 1 m<sup>2</sup> or 1 km<sup>2</sup>.

When people are not grouped in an organised way, the number of people per 1 m<sup>2</sup> expresses the mean of crowding.



### Exercise

- ① Two groups of children are playing in two different garden shelters. One group has 10 children playing in a 8 m<sup>2</sup> garden shelter and the other group has 13 children playing in a 10 m<sup>2</sup> garden shelter.

Which garden shelter is more crowded?

**10 m<sup>2</sup> garden shelter is more crowded**

- ② There are two communities. Samuel's community with 7 km<sup>2</sup> and 1260 people and Robert's community with 10 km<sup>2</sup> and 1850 people.

Which community is more populated?

**1260 ÷ 7 = 180      1850 ÷ 10 = 185**

**Robert's community is more crowded**

□ × □ = 17

$10 \div 8 = 1.25$

$13 \div 10 = 1.3$

## Lesson Flow

### 1 Review the previous lesson

### 2 Understanding how to compare crowdedness using amount per unit quantity.

- T** Introduce the Main Task. (Refer to the Blackboard Plan)
- T** How can we compare the number of students per  $1 \text{ m}^2$ ?
- S** Identify that area of 1 mat is equal to  $1 \text{ m}^2$ , 2 mats is equal to  $2 \text{ m}^2$  and 3 mats is equal to  $3 \text{ m}^2$ .
- T** **3** How can we find the number of students in per  $1 \text{ m}^2$ ?
- S** Explain that the mathematics sentences is the number of students divided by the area of mat.
  - A. is  $12 \div 2 = 6$  students per  $\text{m}^2$ .
  - B. is  $12 \div 3 = 4$  students per  $\text{m}^2$ .
  - C. Is  $15 \div 3 = 5$  students per  $\text{m}^2$ .
- TN** We are using:  $\text{Number of students} \div \text{Area} (\text{m}^2) = \text{Number of students per } 1 \text{ m}^2$ .

### 3 Important Point

- T/S** Explain the important point in the box  .

### 4 Complete the Exercise

- S** Solve the selected exercises.
- T** Confirm students' answers.

### 5 Summary

- T** What have you learned in this lesson?
- S** Present ideas on what they have learned.
- T** Use students' ideas to confirm the important concepts of this lesson.

## Sample Blackboard Plan

**Date:**  
**Chapter:** 2 Amount per Unit Quantity.  
**Topic:** Measurement per Unit Quantity. **Lesson No:** 2/5

**MT:** Let's compare the crowding using per unit quantity.

**Review**

**MT:** Introduce the main task here.

● The area of 1 mat is  $1 \text{ m}^2$ . How many children are there in per  $1 \text{ m}^2$ ?

(A)  $12 \div 2 = \boxed{6}$

(B)  $12 \div 3 = \boxed{4}$

(C)  $15 \div 3 = \boxed{5}$

Number of children

Area ( $\text{m}^2$ )

Number of children per  $1 \text{ m}^2$

**Important Point.**

**Exercise**

(1) Two groups of children are playing in two different garden shelters. One group has 10 children playing in a  $8 \text{ m}^2$  garden shelter and the other group has 13 children playing in a  $10 \text{ m}^2$  garden shelter. Which garden shelter is more crowded?

$10 \div 8 = 1.25$        $13 \div 10 = 1.3$

Answer:  $10 \text{ m}^2$  garden shelter is more crowded.

(2) There are two communities. Samuel community with  $7 \text{ km}^2$  and 1 260 people, Robert's community with  $10 \text{ km}^2$  and 1 850 people. Which community is more populated?

Samuel's Community:  $1\,260 \div 7 = 180$  people per  $1 \text{ km}^2$ .  
Robert's Community:  $1\,850 \div 10 = 185$  people per  $1 \text{ km}^2$ .  
Answer: Robert's Community is more populated.

**Summary**

\* We can express the level of crowdedness by using the number of students in an area of  $1 \text{ m}^2$ .

\* When the number of people are not organised, the number of people per unit quantity is the mean of crowding.

Lesson Objective

- To understand the meaning of population density and find population density.

Prior Knowledge

- Large numbers (Grade 3)
- Decimal Numbers and Whole Numbers (Grade 4)
- Working with two units, number of people and the area (1 m<sup>2</sup> and 1 km<sup>2</sup>)

Preparation

- Chart of task 2
- Chart of table for exercise
- Calculator

Assessment

- Compare population and landmass. **F**
- Explain the meaning of population density. **S**
- Calculate population density correctly. **S**

Teacher's Notes

- Students may use their prior knowledge on division with large numbers to work out their answers or they may use a calculator.
- 2** **TN** For students to visualise the area of the landmass in square km to compare and see which town is bigger before actual calculation.
- The focus is to understand the meaning of population density and to find the population density.
- Students may use calculators to calculate since the numbers are too large to divide with remainders.

Meaning and calculation of population density

2 The table on the right shows the population and the area of East Town and West Town.

1 Let's calculate the number of people per 1 km<sup>2</sup>. Which one is more crowded?

3 800 people/km<sup>2</sup>  
1 300 people/km<sup>2</sup>

Population and Area		
	Population (people)	Area (km <sup>2</sup> )
East Town	273 600	72
West Town	22 100	17



The population per 1 km<sup>2</sup> is called **population density**. The crowdedness of the number of people living in a country or province is compared using population density.

$$\text{Number of people} \div \text{Area (km}^2\text{)} = \text{Number of people per 1 km}^2$$

2 Let's calculate the population density of each province and make a table. Round the first decimal place and give the answers in whole numbers. Find the relationship between population density and area?

Province	Population Density
----------	--------------------

Refer to the answers on the table

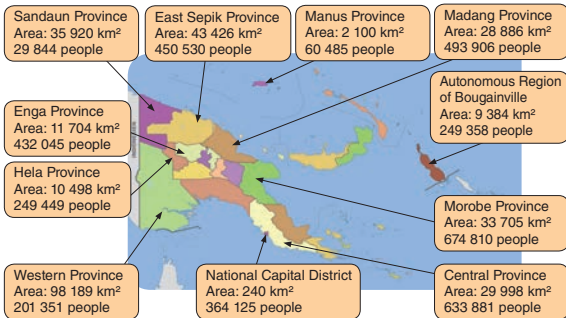

18 = □ + □

Province	Population	Area(km <sup>2</sup> )	Population Density people/km <sup>2</sup>
Sandaun	29 844	35 920	1
ESP	450 530	43 426	10
Manus	60 485	2 100	29
Madang	493 906	28 886	17
AROB	249 358	9 384	27
Morobe	674 810	33 705	20
Central	633 811	29 998	21
NCD	364 125	240	1 517
Western	201 351	98 189	2
Hela	249 449	10 498	24
Enga	432 045	11 704	37

## Lesson Flow

### 1 Review the previous lesson.

### 2 Defining the meaning of population density.

- T** Introduce the Main Task. (Refer to the BP)
- T/S** **2** Read and understand the situation.
- T** Which town has the largest land mass, East town or West town?
- TN** Help students to identify that 72 km<sup>2</sup> is around 9 km × 9 km and 17 km<sup>2</sup> is around 4 km × 4 km.
- S** East town has the largest land mass of 72 km<sup>2</sup> compared to West town which is 17 km<sup>2</sup>.
- T** Comparing East town and West town, which of them has the largest population (number of people).
- S** East town has the largest largest population of 273 600 people compared to West town with 22 100 people.
- T** **1** Let students calculate the number of people per 1 km<sup>2</sup>.
- S** 1. East town  $273\ 600 \div 72 = 3\ 800$  people per km<sup>2</sup>.  
2. West town  $22\ 100 \div 17 = 1\ 300$  people per km<sup>2</sup>.
- T** Which town is more crowded?
- S** East town is more crowded than West town.

### 3 Important Point

- T/S** Explain the important point in the box

### 4 Calculating the population density for each province.

- S** **2** Calculate the population density given in the textbook by using calculators.
- TN** Draw the table and allow the students to fill in the table with the correct information.
- T** Confirm students answers by correcting the exercise with students in class.

### 5 Comparing the population density and the area.

- T** Find the relationship between the population density and area.
- S** The larger the land mass, the population density is smaller, the smaller the land mass, the population density is larger.
- TN** Refer to the Blackboard Plan.

### 6 Summary

- T** What have you learned in this lesson?
- S** Present ideas on what they have learned.
- T** Use students' ideas to confirm the important concepts of this lesson.

## Sample Blackboard Plan

**Date:**  
**Chapter:** 2 Amount per Unit Quantity.  
**Topic:** Measurement per Unit Quantity. **Lesson No:** 3/5

**MT:** Let's compare and calculate population density.

**Review**

**MT:** Introduce the main task here.

[2] The table shows the population and the area of East Town and West Town.

	Population (People)	Area (km <sup>2</sup> )
East Town	273 600	72
West Town	22 100	17

**1** Let's calculate the number of people per 1 km<sup>2</sup>. Which one is more crowded?  
 East Town:  $273\ 600 \div 72 = 3\ 800$  people per 1km<sup>2</sup>.  
 West Town:  $22\ 100 \div 17 = 1\ 300$  people per 1km<sup>2</sup>.  
 Answer: East Town is more crowded.

**Important Point.**

**2** Let's calculate the population density of each province and make a table. Round the first decimal place and give the answers in whole numbers.  
 Find the relationship between population density and area.

Province	Population	Area (km <sup>2</sup> )	Population Density. People /km <sup>2</sup>
Sandau n	29 844	35 920	1
ESP	450 530	43 426	10
Manus	60 485	2 100	29
Madan g	493 906	28 886	17
AROB	249 358	9 384	27
Morobe	674 810	33 705	20
Central	633 811	29 998	21
NCD	364 125	240	1 517
Western	201 351	98 189	2
Hela	249 449	10 498	24
Enga	432 045	11 704	37

**We should conclude from the table that:**

- a) Sandaun and Western Province have the lowest population density.
- b) NCD has the highest population density.
- c) Comparing the population density and the area, the larger the land mass the population density is smaller and the smaller the land mass the population density is big.

**Summary**

- \* The population per 1 km<sup>2</sup> is called the population density.
- \* The number of people ÷ area per km<sup>2</sup> = population density.

Page 23

23

# Unit 2

## Unit: Amount per Unit Quantity Sub-unit 2: Amount per Unit Quantity Lesson 4 of 5

Textbook Page :  
019  
Actual Lesson 012

### Lesson Objectives

- To understand the meaning of per unit quantity.
- To find the whole amount using the per unit quantity.

### Prior Knowledge

- Population Density

### Preparation

- Chart of task 3
- Tape diagrams and tables

### Assessment

- Compare the length and the weight of a wire. **F**
- Identify that the relationship between density and weight per 1 m. **S**

### Teacher's Notes

Students may use their knowledge on division to work out their answers.

The focus is to understand the meaning of **amount per unit quantity**.

### Find the relationship between weight and length

3 A wire is 8 m long and weighs 480 g.

1 How many grams (g) does this wire weigh per 1 m? Let's find the relationship of the numbers from the diagram and the table.

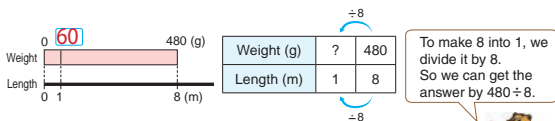

Expression :  $480 \div 8$  Answer: 60 g

### Understanding the meaning of per unit quantity

2 How many g will 15 m of that wire weigh?

Let's develop an expression by drawing a diagram and a table.

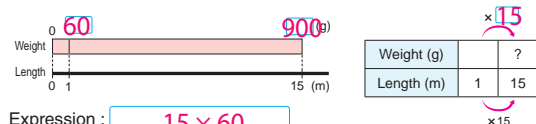

Expression :  $15 \times 60$   
Answer:  $15 \times 60 = 900$  g

### Finding whole amount using the per unit quantity

3 We cut part of the wire and it weighed 300 g.

How many metres (m) long is this piece of wire?

Let's develop an expression by drawing a tape diagram and a table.

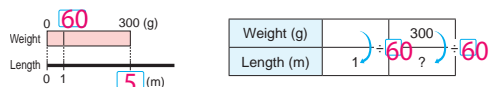

Expression :  $300 \div 60$   
Answer:  $300 \div 60 = 5$  m

Population density and weight per 1 m are called **amount per unit quantity**.

$\square \times \square = 19$



## Lesson Flow

### 1 Review the previous lesson.

### 2 Find the relationship between weight and length.

**T** Introduce the Main Task. (Refer to the Blackboard Plan)

**T/S** **3** Read and understand the situation.

**T** **1** How many grams does per 1 m of this wire weigh?

**S** Use the tape diagram and table to write a mathematical expression. ( $480 \div 8$ )

**TN** Assist the students to identify that, to get 1 m we divide 8 m by 8.

So we can get the answer by using the mathematical expression,  $480 \div 8$ .

**S**  $480 \div 8 = 60$  g so the weight of the wire is 60 g/m.

**T** **2** How many grams will 15 m of that wire weigh?

**S** Using the tape diagram and table, 1 m is 60 g so for 15 m the weight will be  $15 \times 60$

Answer:  $15 \times 60 = 900$  g.

**T** **3** How many m long will the same piece of wire with a weight of 300 g?

**S** From **2**, 1 m is 60 g so 300 g wire will have the length of  $300 \div 60$ .

Answer:  $300 \div 60 = 5$  m.

**T** Assist students to identify that, to find the whole amount, we use the amount per unit quantity in **2**.

### 3 Important Point

**T/S** Explain the important point in the box  .

### 4 Summary

**T** What have you learned in this lesson?

**S** Present ideas on what they have learned.

**T** Use students' ideas to confirm the important concepts of this lesson.

## Sample Blackboard Plan

**Date:**  
**Chapter:** 2 Amount per Unit Quantity.  
**Topic:** Measurement per Unit Quantity. **Lesson No:** 4/5

**MT:** Let's find the relationship between the weight and length and finding the whole amount using the per unit quantity.

**Review**  
**MT: Introduce the main task here.**  
 [3] A wire that is 8 m long and weighs 480g.

**1** How many grams (g) does the wire weigh per 1m. Let's find the relationship of the numbers on the diagram and the table.

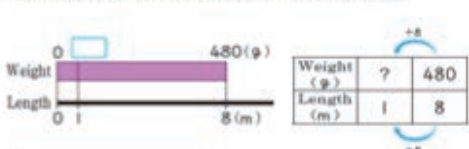

Expression:  $480 \div 8$

$480 \div 8 = 60$   
 Answer: 60 grams.

**2** How many grams will 15 m of that wire weigh? Let's develop an expression by drawing a tape diagram and a table.

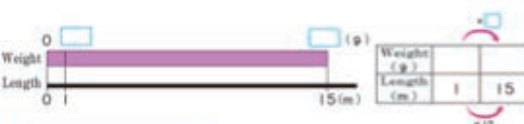

Expression:  $60 \times 15$

$60 \times 15 = 900$   
 Answer: 900 grams.

**3** We cut a piece of wire and it weighed 300g. How many metres long is this piece of wire? Let's develop an expression by drawing a tape diagram and a table.

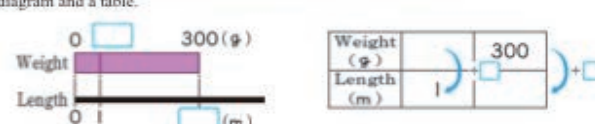

Expression:  $300 \div 60$

$300 \div 60 = 5$   
 Answer: 5 meters.

**Important Point.**

**Summary**

\* Population density and weight per 1 m are called amount per unit quantity.  
 \* First we understand the relationship between known amounts then we find the amount per unit quantity which will help to find the missing amount.

Page 25

# Unit 2

## Unit: Amount per Unit Quantity Sub-unit 2: Amount per Unit Quantity Lesson 5 of 5

Textbook Page :  
020 and 021  
Actual Lesson 013

### Lesson Objectives

- To apply per unit quantity to find the unknown amount.
- To find the amount per unit quantity in various situations.

### Prior Knowledge

- Definition of amount per unit quantity

### Preparation

- Chart of definition for amount per unit quantity on page 20 and 21
- Tape diagrams and tables for all tasks

### Assessment

- Calculate and compare measures per unit quantity. **F**
- Solve the exercises correctly. **S**

### Teacher's Notes

Through these tasks in this lesson the students should be able to understand and apply the meaning of **amount per unit quantity**. For **4** and **5** help the students to interpret the relationship between the known numbers and use them to find the amount per unit quantity.

We can find the amount of unknown quantity when we know the unit per quantity.

For **6** and **7** assist the students to find the known and the unknown numbers to fill in the table.

**4** Ayleen's family grew sweet potatoes in their garden. They harvested 43.2 kg of sweet potatoes from a 6 m<sup>2</sup> at east side and 62.1 kg sweet potatoes from a 9 m<sup>2</sup> at west side. Which side of the garden is good harvest? Compare by using the number of sweet potatoes per 1 m<sup>2</sup>.

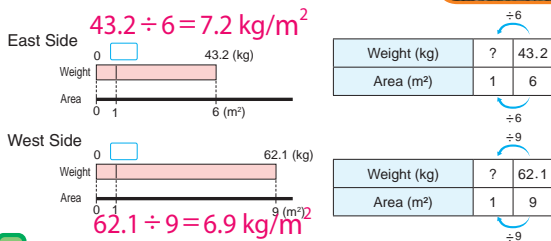

**5** There are two brands of mobile phones. Brand A phone costs 1200 kina for 10 mobile phones. Brand B phone costs 1040 kina for 8 mobile phones. Which one is more expensive?

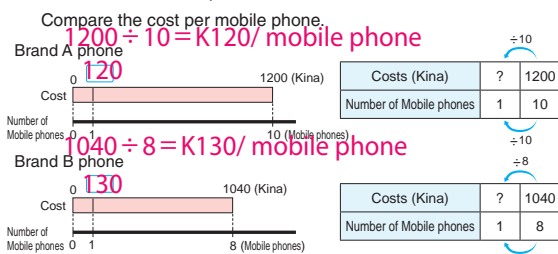

8 mobile phones at K1040 is more expensive

**6** Brand A machine can pump 240 L of water in 8 minutes and Brand B machine can pump 300 L of water in 12 minutes. Which machine pumps more water per minute?

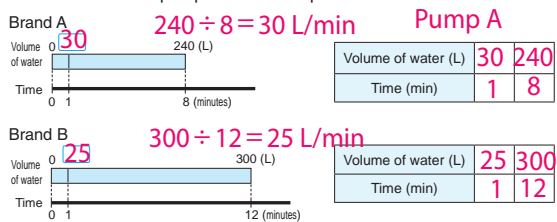

**7** Copier A copies 300 sheets of paper in 4 minutes and copier B copies 380 sheets of paper in 5 minutes.

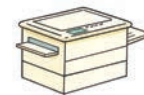

**1** Which copier is faster? **B**

**2** How many sheets of paper can copier A copy in 7 minutes?

**3** How many minutes does it take for copier B to copy 1140 sheets of paper?

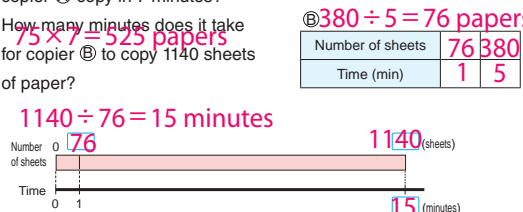

### Exercise

A small tractor ploughs 900 m<sup>2</sup> in 3 hours. How many square metres (m<sup>2</sup>) can it plough in 8 hours?

$900 \div 3 = 300 \text{ m}^2/\text{hr}$

$300 \times 8 = 2400 \text{ m}^2$  Answer: 2400 m<sup>2</sup> in 8 hr

## Lesson Flow

**1** Review the previous lesson.

**2** Compare using the number of sweet potatoes per 1 m<sup>2</sup>.

- T** **4** Introduce the Main Task. (Refer to the BP)
- T/S** Read and understand the situation.
- S** Write mathematical expressions.
- T** Assist students to see the relationship between weight and area and identify which side of the garden is better.
- S** Find the weight of sweet potatoes for 1 m<sup>2</sup> in the East side of the garden and fill in the box. ( $43.2 \div 6 = 7.2$  kg per m<sup>2</sup>)
- S** Find the weight of sweet potatoes for 1 m<sup>2</sup> in the West side of the garden and fill in the box. ( $62.1 \div 9 = 6.9$  kg per 1 m<sup>2</sup>)
- T** Which side of the garden is better?
- S** East side of the garden with 7.2 kg per m<sup>2</sup>.
- T** Confirm students' answers.

**3** Using unit per quantity to compare which mobile phone is more expensive.

- T/S** **5** Read and understand the situation.
- S** Write mathematical expressions.
- S** Find the cost of brand A and fill in the box. ( $1200 \div 10$  to get 120 kina per mobile phone)
- S** The cost of brand B, ( $1040 \div 8 = 130$  kina per mobile phone)
- T** Which brand is more expensive?
- S** Brand B is more expensive.
- T** Confirm students' answers.

**4** Find the unit per quantity for time and volume.

- T/S** **6** Read and understand the situation.

- S** Write mathematical expressions.
- S** Find the volume of water for machine A and fill in the table. ( $240 \div 8 = 30$  L per minute)
- S** Find the volume of water for machine B and fill in the table. ( $300 \div 12 = 25$  L per minute)
- T** Which machine pumps more water per minute?
- S** Machine A.
- T** Confirm students' answers.

**5** Compare the speed of two copiers.

- T/S** **7** Read and understand the situation.
- S** Write mathematical expressions.
- T** **1** Which copier is faster?
- S** Answer is B, 76 papers per minute (refer to board plan for calculation)
- T** **2** How many sheets of paper can copier A copy in 7 minutes?
- S** 75 papers per minute. So for 7 minutes is  $75 \times 7 = 525$  papers.
- T** **3** How many minutes does it take for copier B to copy 1140 sheets of paper?
- S** 76 papers per minute. So for 1140 papers, it will take  $1140 \div 76 = 15$  minutes.
- T** Confirm students' answers.

**6** Complete the Exercise

- S** Solve the exercise.
- T** Confirm students' answers.

**7** Summary

- T** What have you learned in this lesson?
- S** Present ideas on what they have learned.
- T** Use students' ideas to confirm the important concepts of this lesson.

## Sample Blackboard Plan

**Date:**  
Chapter: 2 Amount per Unit Quantity.  
Topic: Measurement per Unit Quantity. Lesson No: 5/5

**MT:** Let's calculate and compare measure per unit quantity in various situations.

**Review**  
**MT:** Introduce the main task here.

[4] Been's family grew sweet potatoes in their garden. They harvested 43.2kg of sweet potatoes from a 6m<sup>2</sup> at east side and 62.1kg from a 9m<sup>2</sup> at west side. Which field is better?

Weight	?	43.2
Area(m <sup>2</sup> )	1	6

Weight	?	62.1
Area(m <sup>2</sup> )	1	9

Expression: East side:  $43.2 \div 6$  and West side:  $62.1 \div 9$

East side:  $43.2 \div 6 = 7.2$  kg/m<sup>2</sup>  
West side:  $62.1 \div 9 = 6.9$  kg/m<sup>2</sup>  
Answer: East side field is better.

[5] There are two types of mobile phones. The first type cost 1 200 kina for 10 mobile phones. The second type cost 1 040 kina for 8 mobile phones. Which one is more expensive?

Cost	?	1200
Number of mobile phones	1	10

Cost	?	1040
Number of mobile phones	1	8

First Type:  $1\ 200 \div 10 = 120$  kina/mobile phone.  
Second Type:  $1\ 040 \div 8 = 130$  kina/mobile phone  
Answer: Second type is more expensive.

[6] Brand A machine can pump 240 L of water in 8 minutes and brand B machine can pump 300 L of water in 12 minutes. Which one pumps more water per minute?

Volume of water (L.)	?	240
Time (Min.)	1	8

Volume of water (L.)	?	300
Time (Min.)	1	12

Brand A:  $240 \div 8 = 30$  L/minute.  
Brand B:  $300 \div 12 = 25$  L/minute.  
Answer: Brand A pumps more water per minute.

[7] Copier A copies 300 sheets of paper in 4 minutes and copier B copies 380 sheets of paper in 5 minutes.

Number of sheets	?	300
Time (Min.)	1	4

Number of sheets	?	380
Time (Min.)	1	5

**Summary**  
\* Tape diagram and table representation are used to compare the amount per unit quantity in various situations.

**1** Which copier is faster?  
Copier A:  $300 \div 4 = 75$  papers/minute.  
Copier B:  $380 \div 5 = 76$  papers/minute.  
Answer: Copier B is faster.

**2** How many sheets of paper can copier A copy in 7 minutes?  $75 \times 7 = 525$  Answer: 525 sheets of papers.

**3** How many minutes does it take for copier B to copy 1 140 sheets of papers?  
 $1\ 140 \div 76 = 15$  Answer: 15 minutes

**Exercise:**  $900 \div 3 = 300$  m<sup>2</sup>/hour.  $300 \times 8 = 2\ 400$  m<sup>2</sup>  
Answer: 2 400 m<sup>2</sup> in 8 hours.

Page 27

# Unit 2

## Unit: Amount per Unit Quantity Excercise, Problems and Evaluation Lesson 1 and 2 of 2

Textbook Pages :  
022 and 023  
Actual Lesson 014 and 015

### Lesson Objective

- To confirm their understanding on the concepts they learned in this unit by completing the Exercise, Problems and the Evaluation Test confidently.

### Prior Knowledge

- All the contents covered in this unit

### Preparation

- Evaluation test copy for each student

### Assessment

- Complete the Exercise and Problems correctly. **S**

### Teacher's Notes

This is the last lesson of Chapter 2. Students should be encouraged to use the necessary skills learned in this unit to complete all the Exercises and solve the Problems in preparation for the evaluation test. The test can be conducted as assesment for your class after completing all the exercises. Use the attached evaluation test to conduct assesment for your class after finishing all the exercises and problems as a seperate lesson.

### EXERCISE

- 1 The table below shows the number of empty cans Anita collected in 5 days. What is the mean number of cans she collected per day? Page 14

Number of Empty Cans Collected					
Days	Day 1	Day 2	Day 3	Day 4	Day 5
Number of cans	6	7	5	8	8

- $34 \div 5 = 6.8$  cans/day
- 2 There are two schools with same size classrooms. Which school (A) or (B) is more crowded? Pages 15 to 17
- $1080 \div 6 = 180$  students/class  
 $1640 \div 8 = 205$  students/class
- (A) 1080 students in 6 classes.  
(B) 1640 students in 8 classes.  
**Answer: School (B) is more crowded**
- 3 A shop sells colour paints. The black paint costs 600 kina for 12 tins and the white paint costs 440 kina for 8 tins. Which colour paint is more expensive? Page 19
- $600 \div 12 = K50$ /paint     $440 \div 8 = K55$ /paint  
**Answer: Second type is more expensive**
- 4 A 180 m<sup>2</sup> plantation produced 432 kg cocoa. How many kilograms (kg) of cocoa were harvested per 1 m<sup>2</sup>? Page 20
- $2.4$  kg/m<sup>2</sup>

Let's calculate.

- ①  $52 \times 27 = 14.04$     ②  $86 \times 67 = 5762$     ③  $35 \times 78 = 2730$   
④  $154 \times 48 = 7392$     ⑤  $565 \times 64 = 36160$     ⑥  $927 \times 32 = 29664$   
⑦  $5.4 \times 4 = 21.6$     ⑧  $6.2 \times 9 = 55.8$     ⑨  $2.5 \times 8 = 20$

22 = □ + □

### PROBLEMS

- 1 The population of a district in PNG is about 39 000 people and the area is about 50 km<sup>2</sup>. Calculate the population density of this district.  
**780 people/km<sup>2</sup>**  
Understanding how to calculate the population density.
- 2 An optical fiber cable costs 480 kina per 4 m.   
Understanding the meaning of measurements per unit.
- ① How much does 1 m of this cable cost? **K120/m**  
② How much does 5 m of this cable cost? **K600**  
③ A company IC Net bought the cable worth 1440 kina. How many metres did the company buy? **12 m**
- 3 A printer can print 350 sheets of paper in 5 minutes.  
Understanding the meaning of amount of work per unit.
- ① How many sheets of paper can it print in 1 minute? **70 sheets /min**  
② How many sheets of paper can it print in 8 minutes? **560 sheets**  
③ How many minutes will it take to print 2100 sheets of paper? **30 min**
- 4 Anton's goal is to read 25 pages of a book per day. He read an average of 23 pages for 6 days from Sunday to Friday. To reach his goal over the 7 days from Sunday, how many pages must he read on Saturday? **25 × 7 - 23 × 6 = 175 - 138 = 37 pages**  
Understanding the relationship between mean, total and number of item.
- 5 The table below shows the duration of handstand and number of grade 5 students at Joyce's school. From this table, let's calculate the average duration of handstand per student in grade 5.  
Understanding the meaning of mean and measurement per unit and applying it to solve problems.

Duration of Handstand and the Number of Grade 5 students

Duration of handstand (second)	0	1	2	3	4	5	6	7	8	9	10
Number of students	3	0	2	4	5	16	9	10	4	6	1

$336 \div 60 = 5.6$  handstand/child

□ × □ = 23

## Lesson Flow

### 1 Complete the Exercise

- S Solve all the exercises.
- T Confirm students' answers.

### 2 Solve the Problems

- S Solve all the problems.
- T Confirm students' answers.
- TN Collect students books for marking if time does not allow.

### 3 Complete the Evaluation Test

- TN Use the attached evaluation test to conduct assesment for your class after finishing all the exercises and problems as a seperate lesson.
- S Complete the Evaluation Test.

<b>End of Chapter Test:</b>	<b>Date:</b>
Chapter 2: Decimal Amount per Unit Quantity	Name:
	Score / 100

[5 x 10 marks for maths expression and 5 x 10 marks for answer]

1. Mr. Pau's flower bed of 15 m<sup>2</sup> has 120 seedlings and Ms. Koro'i's flower bed of 18 m<sup>2</sup> has 135 seedlings. Which flower bed is more crowded?
 

Mathematical Expressions $120 \div 15 = 8.33$ $135 \div 18 = 7.5$	Answer: 15 m <sup>2</sup> flowerbed
---	--
  
2. There are 2 cars, A and B. Car A travels 700 km with 35 Litres of petrol. Car B travels 800km on 50 L of petrol. Which car can travel further if they use same amount of petrol?
 

Mathematical Expressions $700 \div 35 = 20$ $800 \div 50 = 16$	Answer: Car A
--	------------------
  
3. A car drives 150 km with 12 L of petrol. How many km can it drive with 60 L of petrol?
 

Mathematical Expressions $150 \div 12 = 12.5$ $12.5 \times 60 = 750$	Answer: 750 km
--	-------------------
  
4. Kila harvested 63 kg of potatoes from the 50 m<sup>2</sup> field at his house. Asa harvested 108 kg of potatoes from the 80 m<sup>2</sup> field at his house. Which field had a better harvest?
 

Mathematical Expressions $63 \div 50 = 1.26$ $108 \div 80 = 1.35$	Answer: 80m <sup>2</sup> field
---	-----------------------------------
  
5. Betty's result of 5 tests are 81, 95, 78, 86 and 85. What is the average score?
 

Mathematical Expressions $(81+95+78+86+85) \div 5 = 85$	Answer: 85 marks
--	---------------------

**End of Chapter Test****Date:**

Chapter 2: Decimal Amount per Unit Quantity	Name:	Score / 100
--	-------	----------------

[5 × 10 marks for maths expression and 5 × 10 marks for answer]

1. Mr. Pau's flowerbed of 15 m<sup>2</sup> has 120 seedlings and Ms. Koroi's flowerbed of 18 m<sup>2</sup> has 135 seedlings. Which flowerbed is more crowded?.

Mathematical Expressions

Answer:

2. There are 2 cars, A and B. Car A travels 700 km with 35 Litres of petrol. Car B travels 800km with 50 L of petrol. Which car can travel further if both cars use the same amount of petrol?

Mathematical Expressions

Answer:

3. A car travels 150 km with 12 L of petrol. How many km can it travel with 60 L of petrol?

Mathematical Expressions

Answer:

4. Kila harvested 63 kg of potatoes from the 50 m<sup>2</sup> field at his garden. Asa harvested 108 kg of potatoes from the 80 m<sup>2</sup> field at his garden. Whose garden had a better harvest?

Mathematical Expressions

Answer:

5. Betty's result of 5 tests are 81, 95, 78, 86 and 85. What is her average test score?

Mathematical Expressions

Answer:

# Chapter 3 Multiplication of Decimal Numbers

## 1. Content Standard

5.1.4 Apply the process of multiplication to multiply decimal numbers by a decimal number and whole number by a decimal number

## 2. Unit Objectives

- To understand the meanings of and how to calculate multiplication of decimal numbers.
- To solve the problem by applying the method of multiplying decimal numbers.
- To understand that commutative law, associative law and distributive law also apply in the calculation of decimal numbers.

## 3. Teaching Overview

Students learned decimal number  $\times$  whole number in the previous grades.

They will learn operation of whole numbers  $\times$  decimal numbers and operation of decimal numbers  $\times$  decimal numbers in this unit.

### Operation of Whole Numbers $\times$ Decimal Numbers :

Students find out that whole number multiplied by decimal number can be taught as the same as they solved whole number multiplied by whole number.

They can apply the rules of multiplication learned in the previous grades.

### Decimal Number $\times$ Decimal Number :

They apply the learning of the previous sub-unit. In this sub-unit, one of the important learning points is to understand that if a number multiplied by a decimal number less than 0, the answer will be smaller than the first number.

Rules of Calculation : They find out the 3 calculation rules (commutative, associative and distributive laws) are also applied for multiplication of decimal numbers.

## 4. Related Learning Contents

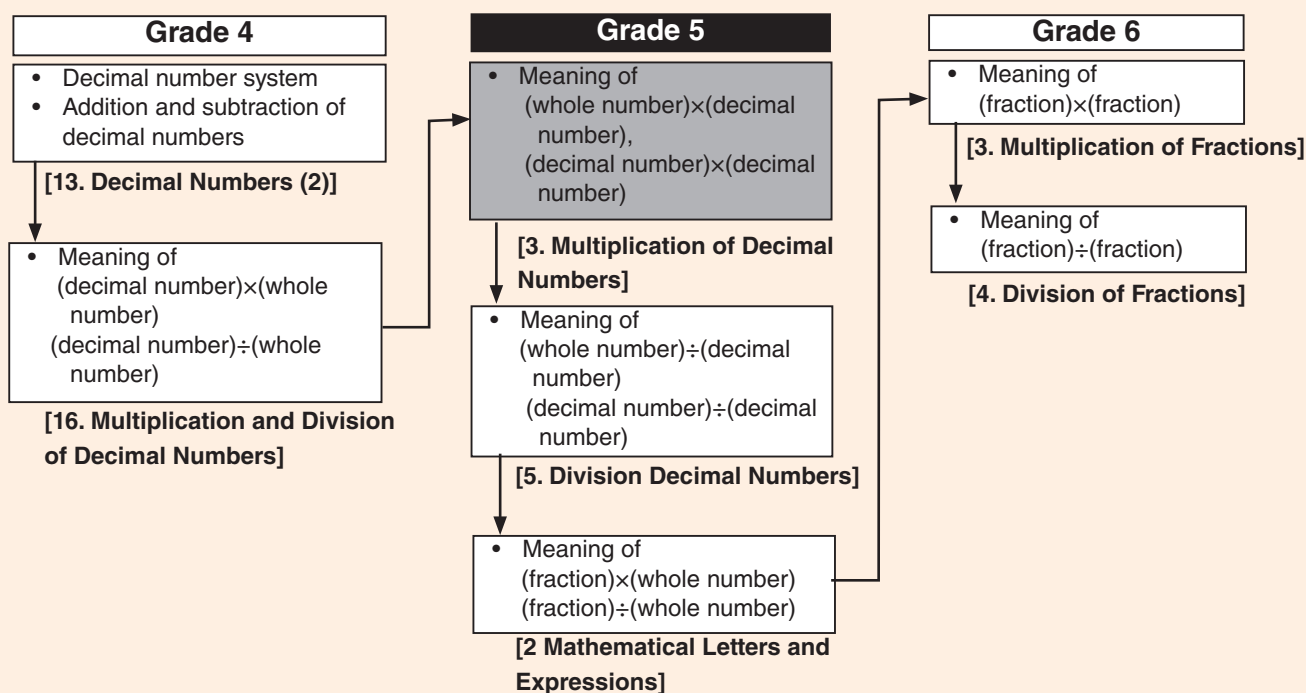

# Unit 3

## Unit: Multiplication of Decimal Numbers Sub-unit 1: Operation of Whole Numbers $\times$ Decimal Numbers Lesson 1 of 2

Textbook Page :  
024 to 026  
Actual Lesson 016

### Sub-unit Objectives

- To understand the meaning of multiplication of decimal number.
- To apply the calculation of multiplication of decimal numbers in vertical form.
- To apply the correct process of multiplying decimal numbers in vertical form.

### Lesson Objective

- To think about how to calculate decimal number  $\times$  decimal number.

### Prior Knowledge

- Multiplication and Division of Decimal Numbers (Grade 4)

### Preparation

- Box and ribbons
- Prepare 6 pieces of 1 metre ribbon

### Assessment

- Think about how to calculate whole number  $\times$  decimal number. **F**
- Explain how to calculate whole number  $\times$  decimal number. **S**

### Teacher's Notes

#### How to convert toea and kina.

100 toea is one kina. Use idea of amount per unit quantity.

In the case where there is no ribbon, improvise with other materials, such as ropes, strings, etc...

3

## Multiplication of Decimal Numbers



### 1 Operation of Whole Numbers $\times$ Decimal Numbers

Moris is thinking about wrapping a present box with a ribbon around it. He needs 2.4 m of ribbon.

#### Meaning and how to calculate Whole number $\times$ Decimal number

- The price of the ribbon is 80 toea per 1 m. Let's find out how much it would cost for 2.4 m.

- Draw a number line with a tape diagram.

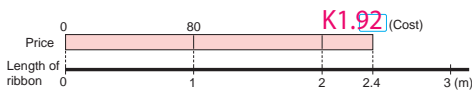

- Write a mathematical expression.

Price (toea)	80	?
Length of ribbon (m)	1	2.4

Expression:  $80 \times 2.4$

$24 = \square \times \square$

- Approximately, how much would the cost be?

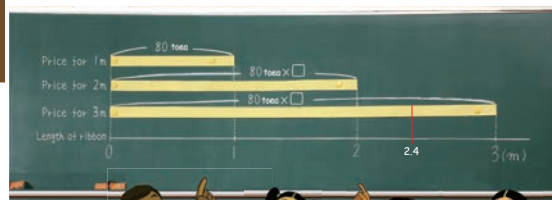

It's more expensive than the price for 2 m and cheaper than the price for 3 m, so it would be around 200 toea (K2).

It should be less than the price between 160 toea (K1.60) and 240 toea (K2.40).

2.4 m is about a half of 5 m and 5 m costs 400 toea (K4), so half of it would be around K2.



As shown with the length of the ribbon, when the multiplier is a decimal number instead of a whole number, the expression is the same as for multiplication of whole numbers.

- Let's think about how to calculate.



$\square - \square = 25$



## Lesson Flow

### 1 Introduction

- T** Ask a student to demonstrate how to wrap a box with a 1 m ribbon around it in front of the class.
- T** Is the ribbon long enough to wrap the box?
- S** Give responses from their observation.

### 2 How to calculate whole number $\times$ decimal number.

- T** Introduce the Main Task. (Refer to the BP)
- T/S** **1** Read and understand the situation.
- T** The price of the ribbon is 80 toea per metre. Let's find out how much 2.4 m will it.
- S** **1** Draw a number line with a tape diagram.
- T** **2** Write a mathematical expression.
- S**  $80 \times 2.4$

### 3 Estimating how much the total cost will be.

- T** **3** Approximately, how much would the cost be?
- TN** Put up the three tapes of 1 m, 2 m and 3 m.
- S** Give various responses according to their own estimations corresponding to the tapes and the cost.
- T** Check students' estimations and relate to the speech bubbles.

### 4 Important Point

- T/S** Explain the important point in the box  .

### 5 Think about how to calculate.

- T** Let the students to think about and present their ideas.
- S** Present their ideas.

### 6 Explain Kekeni's and Vavi's Ideas.

- T** **5** Direct the students attention to look at how Kekeni's and Vavi's Ideas are expressed.
- T** Explain Kekeni's and Vavi's ideas.
- S** Kekeni's Idea:

Firstly, I thought about the price of 0.1 m. According to the price of 0.1 m ( $80 \div 10 = 8$  toea), therefore, 2.4 is 24 of 0.1 m. So now the price of 2.4 is  $8 \times 24 = \text{K}192$ . Another similar sample is from the table of information.

Vavi's Idea: I used the rules of multiplication to multiplying by whole numbers. If 2.4 is the amount for 1 ribbon, then the amount for 10 ribbons would be 24 m.

If the cost of 10 ribbons is  $80 \times 24 = 1920$  (K19.20)

Then, the cost for 1 ribbon would be  $\frac{1}{10}$  of  $1920 = 192$  (K1.92)

Another sample is shown on the number line.

- S** Understand and make meaning of the two ideas.
- TN** Interact with students through the explanations.

### 7 Summary

- T** What have you learned in this lesson?
- S** Present ideas on what they have learned.
- T** Use students' ideas to confirm the important concepts of this lesson.

## Sample Blackboard Plan

Lesson 016 Sample Blackboard Plan is on page 35.

**5** Let's explain the ideas below.

**Kekeni's Idea**

1 m = 80 toea  
 Price of 0.1 m  $80 \div 10 = 8$  (toea)  
 2.4 m is 24 of 0.1 m, so,  
 Price of 2.4 m  
 $8 \times 24 = 192$  (toea)

Firstly, I thought about the price of 0.1 m.

**Vavi's Idea**

Suppose 2.4 m is needed to wrap 1 box, then 24 m is needed for wrapping 10 boxes.

I used the rules of multiplication for multiplying by whole numbers.

Cost for 1 ribbon  $80 \times 2.4 = 192$   
 $\times 10$   
 Cost for 10 ribbons  $80 \times 24 = 1920$

$\times 10$  means 10 times and  $\frac{1}{10}$  means  $\frac{1}{10}$  of a number.

**6** Let's explain how to multiply  $80 \times 2.4$  in vertical form.

$$\begin{array}{r} 80 \\ \times 2.4 \\ \hline 320 \\ 160 \\ \hline 192.0 \end{array}$$

$$\begin{array}{r} 80 \\ \times 10 \\ \hline 800 \end{array}$$

Which idea in **5** is the same as this?

26 =

**Lesson Objective**

- To understand how to calculate whole number x decimal number in vertical form.

**Prior Knowledge**

- Meaning of Whole Number x Decimal Number and how to calculate.

**Preparation**

- Chart of How to multiply  $80 \times 2.4$  in vertical form
- Chart showing the diagram interpretation of unit idea for Task 2 2.

**Assessment**

- Think about how to calculate whole number x decimal number in vertical form. **F**
- Think about how to calculate whole number x decimal number in vertical form. **F**
- Explain how to calculate whole number x decimal number in vertical form. **S**
- Explain how to calculate whole number x decimal number in vertical form. **S**
- Solve the exercise correctly. **S**
- Solve the exercise correctly. **S**

**Teacher's Notes**

When converting decimal numbers to whole numbers for easier calculations, always write the products as original decimal numbers. Explain and present the problem in vertical form. To change the decimal number to a whole number, we multiply by 10 because there is one number after the decimal point, when calculations are done the result or answer is the product.

The decimal point should be placed on the number of places from the left to the right.

In this case it is one place after the decimal point.

The product is 192.0

5 Let's explain the ideas below.

**Kekeni's Idea**

1 m = 80 toea  
Price of 0.1 m  $80 \div 10 = 8$  (toea)  
2.4 m is 24 of 0.1 m, so,  
Price of 2.4 m  $8 \times 24 = 192$  (toea)

8 x  $\square = \square$  (toea)

**Vavi's Idea**

Suppose 2.4 m is needed to wrap 1 box, then 24 m is needed for wrapping 10 boxes.

Cost for 1 ribbon  $80 \times 2.4 = \square$   
Cost for 10 ribbons  $80 \times 24 = 1920$

$\times 10$  means 10 times and  $\frac{1}{10}$  means  $\frac{1}{10}$  of a number.

**How to calculate Whole number x Decimal number in vertical form**

6 Let's explain how to multiply  $80 \times 2.4$  in vertical form.

Which idea in 5 is the same as this?

**Multiplication Algorithm of Decimal Numbers in Vertical Form**

- We ignore the decimal points and calculate as whole numbers.
- We put the decimal point of the product in the same position from the right as the decimal point of the multiplier.

...Number of digits after the decimal point is 1.  
...Number of digits after the decimal point is 1.

- What is the area in  $m^2$  of a rectangular flowerbed that is 3 m wide and 2.5 m long?

- Write a mathematical expression.  
 $3 \times 2.5$
- Approximately what is the area in  $m^2$ ?

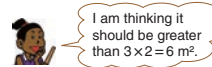

- Calculate the answer in vertical form.

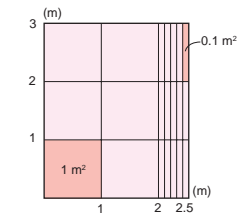

6 of  $1 m^2$  is  $6 m^2$   
15 of  $0.1 m^2$  is  $1.5 m^2$   
Total  $7.5 m^2$

**Exercise**

Let's multiply in vertical form.

- $60 \times 4.7 = 282$
- $50 \times 3.9 = 195$
- $7 \times 1.6 = 11.2$
- $6 \times 2.7 = 16.2$
- $24 \times 3.3 = 79.2$
- $13 \times 2.8 = 36.4$

## Lesson Flow

**1** Review the previous lesson.

**2** **6** Let's explain how to multiply whole number  $\times$  decimal number in vertical form

**S** Explain in their own words how to multiply  $80 \times 2.4$  in vertical form.

**TN** Refer to Teacher's Notes for explanation.

**T** Introduce the Main Task. (Refer to the BP)

**3** How to multiply  $80 \times 2.4$  in vertical form.

**S** Explain in their own understanding on how to calculate  $80 \times 2.4$  in vertical form.

**T** Refer students to the textbook and confirm how to multiply in vertical form.

**4** Calculate  $3 \times 2.5$  in vertical form.

**T/S** **2** Read and understand the given situation

**T** **1** Write a mathematical expression.

**S**  $3 \times 2.5$

**T** **2** Approximately what is the area in  $m^2$  ?

**S** Estimate that the area should be greater than  $3 \times 2 = 6 m^2$ .

**T** **3** Ask students to calculate the answer in vertical form.

**S** Carefully think through the calculation process in vertical form and fill in the boxes.

**TN** Refer to board plan for answers.

**T/S** Explain the diagram representation and confirm with the vertical calculation.

**5** Complete the Exercise

**S** Solve the selected exercises.

**T** Confirm students' answers.

**6** Summary

**T** What have you learned in this lesson?

**S** Present ideas on what they have learned.

**T** Use students' ideas to confirm the important concepts of this lesson.

## Sample Blackboard Plan (Lesson 16)

**Date:**  
**Chapter:** 3 Multiplication of Decimal Numbers.  
**Topic:** Calculating of Whole Numbers  $\times$  Decimal Numbers  
**Lesson No:** 1/2

**MT:** Let's think about how to calculate whole numbers  $\times$  decimal numbers.

**Introduction:**

**MT:** introduce the main task here.

[1] The price of the ribbon is 80 toea per meter. Let's find out how much would it cost for 2.4m

**1** Draw a number line with a tape diagram.

**2** Write a mathematical expression.

Price (Cost)	80	?
Length of ribbon (m)	1	2.4

$\times$

Expression:  $80 \times 2.4$

**3** Approximately, how much would be the cost? Students responses and estimations based on the speech bubbles.

**Important Point.**

**4** Let's think about how to calculate. Students present their ideas.

**5** Let's explain the ideas in the textbook.

Refer to the text book for the explanations.

**Summary**

\*Even when the multiplier is a decimal number, the expression will be the same as multiplication of whole numbers.

## Sample Blackboard Plan (Lesson 17)

**Date:**  
**Chapter:** 3 Multiplication of Decimal Numbers.  
**Topic:** Calculating Whole Numbers  $\times$  Decimal Numbers  
**Lesson No:** 2/2

**MT:** Let's think about how to calculate whole numbers  $\times$  decimal numbers in vertical form.

**Review**

**MT:** Introduce the main task here.

**1** Let's explain how to multiply  $80 \times 2.4$  in vertical form.

Write down students ideas.

$$\begin{array}{r} 80 \\ \times 2.4 \\ \hline 320 \\ 160 \\ \hline 192.0 \end{array}$$

One  $\times$  10  $\rightarrow$  times 10  $\rightarrow$

$$\begin{array}{r} 80 \\ \times 24 \\ \hline 320 \\ 160 \\ \hline 1920 \end{array}$$

One  $\div$  10  $\rightarrow$

**How to Multiply  $80 \times 2.4$  in Vertical Form**

(1) We ignore the decimal points and calculate as whole numbers.

(2) We put the decimal point of the product in the same position from the right as the decimal point of the multiplier.

		3
$\times$	2	5
	1	5
	6	
	7	5

6 of  $1m^2$  is  $6 m^2$   
15 of  $0.1m^2$  is  $1.5 m^2$   
Total  $7.5 m^2$

[2] What is the area in  $m^2$ , of a rectangle flower bed that is 3m wide and 2.5m long?

**1** Write a mathematical expression.  $3 \times 2.5$

**2** Approximately what is the area in  $m^2$ ?  
The estimation area should be greater than  $3 \times 2 = 6 m^2$ .

**3** Calculate the answer in vertical form.

**Exercise**  
Let's multiply in vertical form.

①  $60 \times 4.7 = 282$

④  $6 \times 2.7 = 18.2$

②  $50 \times 3.9 = 195$

⑤  $24 \times 3.3 = 79.2$

③  $7 \times 1.6 = 11.2$

⑥  $13 \times 2.8 = 36.4$

**Summary**

When multiplying whole numbers with decimal numbers in vertical form:

- We ignore the decimal point and multiply as whole numbers.
- Then put the decimal point of the product in the same position from the right as the decimal point of the multiplier.

**Sub-unit Objectives**

- To think about how to calculate decimal number × decimal number.
- To understand how to calculate decimal number × decimal number in vertical form.

**Lesson Objective**

- To think about how to calculate decimal number × decimal number.

**Prior Knowledge**

- How to calculate Whole number × Decimal Number in vertical form
- Calculating Whole numbers × Decimal Numbers

**Preparation**

- A chart of the number line and the table of information

**Assessment**

- Think about how to multiply decimal number × decimal number. **F**
- Explain how to calculate decimal number × decimal number. **S**

**Teacher's Notes**

In this problem, both Sare's and Yamo's ideas include the rule of multiplication.

- If multiplicand is multiplied by 10, the product should be multiplied by  $\frac{1}{10}$ .
- If both multiplicand and multiplier are multiplied by 10, the product is multiplied by  $\frac{1}{100}$ .

**Meaning of Decimal number × Decimal Number**

**2 Operation of Decimal Numbers × Decimal Numbers**

**1** Hiro can paint 2.1 m<sup>2</sup> of wall with 1 dL paint. How many m<sup>2</sup> of wall can he paint with 2.3 dL?



**1** Let's draw a tape diagram and then write a mathematical expression.

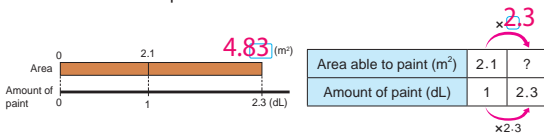

Mathematical expression.  $2.1 \times 2.3$

**2** Let's think about how to calculate.

**Sare's Idea**

We learned how to calculate (Decimal number) × (Whole number), thus using the rule of multiplication.

$$2.1 \times 2.3 = 4.83$$

$$2.1 \times 23 = 48.3$$

**Yamo's Idea**

Then, it's better to change it into (Whole number) × (Whole number).

$$2.1 \times 2.3 = 4.83$$

$$21 \times 23 = 483$$

## Lesson Flow

**1** Review the previous lesson.

**2** Making meaning of decimal number  $\times$  decimal number

**T** Introduce the Main Task. (Refer to the Blackboard Plan)

**T/S** **1** Read and understand the given situation.

**T** **1** Assist the students to understand the given situation and draw a diagram, then, make a mathematical expression.

**T** If 1 dL can paint 2.1 m<sup>2</sup>, how many m<sup>2</sup> of wall will be painted with 2.3 dL?

**S** Using their prior knowledge, draw a line diagram similar to the drawing in the textbook.

**S** Mathematical expression:  $2.1 \times 2.3$

**3** To think about how to calculate  $2.1 \times 2.3$  using prior knowledge.

**T** Discuss in their groups or in pairs about how to calculate  $2.1 \times 2.3$

**S** Present their ideas and explain.

**4** **2** Let's think about how to calculate  $2.1 \times 2.3$

**S** Think about and explain Sare's and Yamo's ideas.

**T** Emphasise the ideas above with explanations to clarify any misconceptions.

**5** Summary

**T** What have you learned in this lesson?

**S** Present ideas on what they have learned.

**T** Use students' ideas to confirm the important concepts of this lesson.

## Sample Blackboard Plan

**Date:**  
**Chapter:** 3 Multiplication of Decimal Numbers.  
**Topic:** Operation of Decimal Numbers x Decimal Numbers  
**Lesson No:** 1/3

: Let's think about how to calculate decimal numbers x decimal numbers.

**Review**  
**MT: Introduce the main task here.**

[1] We can paint 2.1m<sup>2</sup> of wall with 1 dL paint. How many m<sup>2</sup> of wall will we paint with 2.3 dL?

**1** Let's draw a tape diagram then write a mathematical expression.

Area able to paint (m <sup>2</sup> )	2.1	?
Amount of paint (dL)	1	2.3

Mathematical Expression.

2.1

x

2.3

Area able to paint with 1dL.      Amount of paint.

**2** Let's think about how to calculate. Write down students' ideas.

Refer to the text book and explain the two ideas.

Asa's Idea: Prior knowledge Decimal Number x whole Number using rule of multiplication.

$$\begin{array}{r} 2.1 \times 2.3 = \\ \downarrow \times 10 \\ 2.1 \times 23 = \end{array}$$

$$\begin{array}{r} 4.83 \\ \uparrow \\ 48.3 \end{array}$$

Raka's Idea: Change the two decimal numbers to Whole Number x Whole Number

$$\begin{array}{r} 2.1 \times 2.3 = \\ \downarrow \times 10 \quad \downarrow \times 10 \\ 21 \times 23 = \end{array}$$

$$\begin{array}{r} 4.83 \\ \uparrow \\ 48.3 \end{array}$$

**Summary**  
 When calculating decimal numbers by decimal numbers ;

- We can apply the rule of multiplication.
- We can change to whole numbers x whole numbers then multiply the product by 1/10 or 1/100 to move the decimal point of the product.

Page: \_\_\_\_\_

# Unit 3

## Unit: Multiplication of Decimal Numbers Sub-unit: 2. Operation of Decimal Numbers × Decimal Numbers Lesson 2 of 3

Textbook Page :  
029 and 030  
Actual Lesson 019

### Lesson Objective

- To understand how to calculate decimal number × decimal number in vertical form.

### Prior Knowledge

- The product of the right end number becomes 0
- Calculating Decimal Number × Decimal Number

### Preparation

- A chart expressing the unit idea in a diagram

### Assessment

- Explain decimal number × decimal number in vertical form. **F**
- Solve the exercise correctly. **S**

### Teacher's Notes

In task 2, the calculation is done in vertical form applying the prior knowledge about the unit idea (diagram of the rectangular flowerbed).

Assist the students to visualise the area using the unit idea to understand how the decimal point is arranged and calculated.

### How to multiply Decimal number × Decimal number in vertical form

Let's explain how to multiply  $2.1 \times 2.3$  in vertical form.

$$\begin{array}{r} 2.1 \\ \times 2.3 \\ \hline 42 \\ 483 \\ \hline 483 \end{array}$$

One  $\times 10 \rightarrow 21$   
One  $\times 10 \rightarrow 23$   
Two  $\times 100 \rightarrow 483$

What is the area in  $m^2$  of a rectangular flowerbed that is 2.4 m wide and 3.1 m long?

Let's write a mathematical expression.

$$2.4 \times 3.1$$

Let's multiply in vertical form.

$$\begin{array}{r} 2.4 \\ \times 3.1 \\ \hline 24 \\ 72 \\ \hline 7.44 \end{array}$$

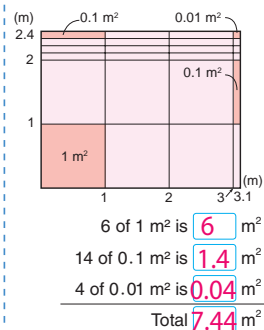

The area of rectangles can be calculated by using the formula even if the lengths of the sides are decimal numbers.

#### Exercise

Let's multiply in vertical form.

- ①  $1.2 \times 2.4$  **2.88**    ②  $8.6 \times 1.3$  **11.18**    ③  $6.4 \times 3.5$  **22.4**  
④  $2.5 \times 2.8$  **7**    ⑤  $0.2 \times 1.6$  **0.32**    ⑥  $0.8 \times 2.5$  **2**

### Calculating Decimal number × Decimal number in vertical form

Let's think about how to multiply  $5.26 \times 4.8$  in vertical form.

$$\begin{array}{r} 5.26 \\ \times 4.8 \\ \hline 4208 \\ + 2104 \\ \hline 25.248 \end{array}$$

Two  $\times 100 \rightarrow 526$   
One  $\times 10 \rightarrow 48$   
Three  $\times 1000 \rightarrow 25248$

When multiplying in vertical form, place the decimal point on the product by adding the number of digits after the decimal point of the multiplicand and the multiplier and count from the right end of the product.

The product where the right of the decimal point becomes zero (0)

Let's think about how to multiply  $4.36 \times 7.5$

$$\begin{array}{r} 4.36 \\ \times 7.5 \\ \hline 2180 \\ 3052 \\ \hline 32700 \end{array}$$

$\times 100 \rightarrow 436$   
 $\times 10 \rightarrow 4360$   
 $\times 1000 \rightarrow 32700$

The position of decimal point in the product. Let's put decimal points on the products for the following calculations.

①  $\begin{array}{r} 5.6 \\ \times 4.3 \\ \hline 168 \\ 224 \\ \hline 2408 \end{array}$     ②  $\begin{array}{r} 3.27 \\ \times 1.2 \\ \hline 654 \\ 327 \\ \hline 3924 \end{array}$     ③  $\begin{array}{r} 1.48 \\ \times 2.5 \\ \hline 740 \\ 296 \\ \hline 3700 \end{array}$

#### Exercise

Let's multiply in vertical form.

- ①  $3.14 \times 2.6$  **8.164**    ②  $4.08 \times 3.2$  **13.056**    ③  $7.24 \times 7.5$  **54.3**  
④  $1.4 \times 4.87$  **6.818**    ⑤  $4.8 \times 2.87$  **13.776**    ⑥  $8.2 \times 2.25$  **18.45**

## Lesson Flow

### 1 Review the previous lesson.

### 2 Explain how to multiply $2.1 \times 2.3$

**T** ① ③ Explain how to multiply  $2.1 \times 2.3$  in vertical form while students follow through using the textbook.

**TN** One decimal place number  $\times$  one decimal place number gives a total of two decimal places number as the product.

**T** Introduce the Main Task. (Refer to the BP)

### 3 Explain how to calculate $2.4 \times 3.1$

**S** ② ① Read and understand the situation and write a mathematical expression as  $2.4 \times 3.1$

**T** ② Let's multiply  $2.4 \times 3.1$  in vertical form.

**S** Calculate  $2.4 \times 3.1$  in vertical form.

**T** Explains the area diagram representation.

**S** Correspond with the explanation to fill in the box for the diagram representation.

**T** Confirm answers in relation to the diagram representation and vertical calculation.

### 4 Important Point

**T/S** Explain the important point in the box  .

### 5 Complete the Exercise

**S** Solve the selected exercises.

**T** Confirm students' answers.

### 6 Think about how to multiply $5.26 \times 4.8$ in vertical form.

**T** ③ Let's think about how to multiply  $5.26 \times 4.8$

**S** Explain how to multiply  $5.26 \times 4.8$  in vertical form using the textbook.

**TN** Two decimal place number  $\times$  one decimal place number gives a total of three decimal place number as the product.

### 7 Important Point

**T/S** Explain the important point in the box  .

### 8 Think about how to multiply $4.36 \times 7.5$ in vertical form when the product of the right end becomes 0.

**T** Refer to ③ as an example to complete ④.

**TN** Emphasise on the answer where zeros (0) at the end of the product of the decimal numbers are insignificant.

**S** Fill in the boxes.

### 9 To think about the position of decimal points.

**T** ⑤ Let's put decimal points on the products for the following calculations.

**S** 1.)  $5.6 \times 4.3 = 24.08$     2.)  $3.27 \times 1.2 = 3.924$   
3.)  $1.48 \times 2.5 = 3.700$

### 10 Complete the Exercise

**S** Solve the selected exercises.

**T** Confirm students' answers.

### 11 Summary

**T** What have you learned in this lesson?

**S** Present ideas on what they have learned.

**T** Use students' ideas to confirm the important concepts of this lesson.

## Sample Blackboard Plan

**Date:**  
**Chapter:** 3 Multiplication of Decimal Numbers.  
**Topic:** Operation of Decimal Numbers  $\times$  Decimal Numbers  
**Lesson No:** 2/3

**MT:** Let's think about how to calculate decimal numbers  $\times$  decimal numbers in vertical form.

**Review**

**MT:** Introduce the main task here.

① Let's explain how to multiply  $2.1 \times 2.3$  in vertical form.

$$\begin{array}{r} 2.1 \\ \times 2.3 \\ \hline 63 \\ 420 \\ \hline 4.83 \end{array}$$

One  $\rightarrow$  10 times  $\rightarrow$  21  
One  $\rightarrow$  10 times  $\rightarrow$  23  
Two  $\rightarrow$  100  $\rightarrow$  42

[2] What is the area in  $m^2$  of a rectangular flower bed that is 2.4m wide and 3.1m long?

① Let's write a mathematical expression.  $2.4 \times 3.1$

② Let's multiply in vertical form.

$$\begin{array}{r} 2.4 \\ \times 3.1 \\ \hline 24 \\ 720 \\ \hline 7.44 \end{array}$$

① of  $1m^2$  in  $3m^2$   
② of  $0.1m^2$  in  $1.4m^2$   
④ of  $0.01m^2$  in  $0.04m^2$   
Total  $7.44m^2$

**Important Point.**

**Exercise**

Let's multiply in vertical form.

①  $1.2 \times 2.4 = 2.88$     ②  $8.6 \times 1.3 = 11.18$     ③  $6.4 \times 3.5 = 22.4$   
④  $2.5 \times 2.6 = 6.5$     ⑤  $0.2 \times 1.6 = 0.32$     ⑥  $0.8 \times 2.5 = 2$

[3] Let's think about how to multiply  $5.25 \times 4.8$  in vertical form.

$$\begin{array}{r} 5.25 \\ \times 4.8 \\ \hline 2104 \\ 4200 \\ \hline 25.200 \end{array}$$

Two  $\rightarrow$  100 times  $\rightarrow$  525  
One  $\rightarrow$  10 times  $\rightarrow$  48  
Three  $\rightarrow$  1000  $\rightarrow$  25248

**Important Point.**

**Exercise**

Let's multiply in vertical form.

①  $3.14 \times 2.6 = 8.164$     ②  $4.08 \times 3.2 = 13.056$     ③  $7.24 \times 7.5 = 54.3$   
④  $1.4 \times 4.87 = 6.818$     ⑤  $4.8 \times 2.87 = 13.776$     ⑥  $8.2 \times 2.25 = 18.45$

**Summary**

When multiplying a decimal number  $\times$  decimal number;

- Multiply as whole numbers ignoring the decimal point.
- Add the number of decimal places in the multiplier and multiplicand.
- Count from the right end of the product and place the decimal

**Important Point.**

[4] Let's think about how to multiply  $4.36 \times 7.5$

$$\begin{array}{r} 4.36 \\ \times 7.5 \\ \hline 2180 \\ 3052 \\ \hline 32.700 \end{array}$$

$\times 100 \rightarrow$   $\begin{array}{r} 436 \\ \times 75 \\ \hline 2180 \\ 3052 \\ \hline 32700 \end{array}$   
 $\div 1000$

[5] Let's put decimal points on the products for the following calculations.

①  $5.6$   
 $\times 4.3$   
 $\hline 168$   
 $224$   
 $\hline 2408$

②  $3.27$   
 $\times 1.2$   
 $\hline 654$   
 $327$   
 $\hline 3924$

③  $1.48$   
 $\times 2.5$   
 $\hline 740$   
 $296$   
 $\hline 3700$

# Unit 3

## Unit: Multiplication of Decimal Numbers Sub-unit 2: Operation of Decimal Numbers × Decimal Numbers Lesson 3 of 3

Textbook Page :  
031  
Actual Lesson 020

### Lesson Objective

- To understand the relationship between the product and the multiplicand.

### Prior Knowledge

- Calculating Decimal Number × Decimal Number in vertical form

### Preparation

- A chart of a Tape diagram (Number Line) and Table of Information for task 6

### Assessment

- Explain the relationship between the product and the multiplicand. **F S**
- Solve the exercises correctly. **S**

### Teacher's Notes

- When the multiplier is more than 1, the product is more than the multiplicand.  
 $25 \times 6 = 150$   
multiplicand multiplier product
- When the multiplier is a decimal number less than 1, the product is less than the multiplicand.  
 $25 \times 0.6 = 15$   
multiplicand multiplier product
- When the multiplier is more than 1, the product is more than the multiplicand.  
 $0.25 \times 6 = 1.5$   
multiplicand multiplier product
- When the multiplier is a decimal number less than 1, the product is less than the multiplicand.  
 $0.25 \times 0.6 = 0.15$   
multiplicand multiplier product

#### Multiplication of Decimal Numbers Smaller than 1

- 6 There is a metal bar that weighs 3.1 kg per metre.  
What is the weight of 1.2 m and 0.8 m of this bar respectively?

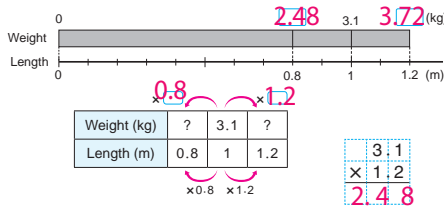

- Let's find the weight of 1.2 m metal bar.  
 $3.1 \times 1.2 = 3.72$  Answer: 3.72 kg
- Let's find the weight of 0.8 m metal bar.  
 $3.1 \times 0.8 = 2.48$  Answer: 2.48 kg
- Let's compare the sizes of the products and the multiplicands.

**When the multiplier decreases, the product decreases.**

When the multiplier is a decimal number smaller than 1, the product becomes smaller than the multiplicand.  
If the multiplier is a decimal number larger than 1, Multiplicand < Product.  
If the multiplier is a decimal number less than 1, Multiplicand > Product.

- 7 Put decimal points on the products and compare the products and the multiplicands.

$$\begin{array}{r} 1 \quad 25 \\ \times 6 \\ \hline 150 \end{array} \quad \begin{array}{r} 2 \quad 25 \\ \times 0.6 \\ \hline 15.0 \end{array}$$

#### Exercise

Let's multiply in vertical form.

- ①  $4.2 \times 0.7 = 2.94$     ②  $6.8 \times 0.4 = 2.72$     ③  $0.8 \times 0.3 = 0.24$   
④  $2.17 \times 0.6 = 1.302$     ⑤  $0.14 \times 0.5 = 0.07$     ⑥  $0.07 \times 0.2 = 0.014$

$\square - \square = 31$



## Lesson Flow

**1** Review the previous lesson.

**2** Find the relationship between the length and the weight.

**T/S** Read and understand the situation.

**T** Introduce the Main Task. (Refer to the BP)

**T** **6** Ask students to interpret the tape diagram and the table.

**S** Interpret the tape diagram and the table and fill in the boxes.

**T** **1** Let's find the weight of 1.2 m metal.

**S** Write the mathematical expression as  $3.1 \times 1.2$  and calculate in vertical form.

**TN** Having the idea that  $3.1 \text{ kg} = 1 \text{ m}$ .

Then,  $3.1 \times 1.2 = 3.72$  Answer: 3.72 kg

**T** **2** Let's find the weight of 0.8 m metal.

**S** Write the mathematical expression as  $3.1 \times 0.8$  and calculate in vertical form.

**S** So  $3.1 \times 0.8 = 2.48$  Answer: 2.48 kg

**3** **3** Compare the size of the product and the multiplicand.

**T** Let's compare the size and understand the relationship between the product and the multiplicand.

**S** Explain the relationship between the product and the multiplicand. (Refer to the Teacher's Notes)

**4** Important Point

**T/S** Explain the important point in the box  .

**5** **7** Positions of the decimal points and comparing.

**S** Complete **1** and **2** and compare the products and the multiplicands.

**TN** **1** a.)  $25 \times 6 = 150$

When the multiplier is more than 1, the product is more than the multiplicand.

b.)  $25 \times 0.6 = 15.0$  Answer: 15

When the multiplier is a decimal number and its less than 1, the product is less than the multiplicand.

**TN** **2** a.)  $0.25 \times 6 = 1.50$  Answer: 1.5

When the multiplier is more than 1, the product is more than the multiplicand.

b.)  $0.25 \times 0.6 = 0.150$  Answer: 0.15

When the multiplier is a decimal number and its less than 1, the product is less than the multiplicand.

**6** Complete the Exercise

**S** Solve the selected exercises.

**T** Confirm students' answers.

**7** Summary

**T** What have you learned in this lesson?

**S** Present ideas on what they have learned.

**T** Use students' ideas to confirm the important concepts of this lesson.

## Sample Blackboard Plan

**Date:**  
**Chapter:** 3 Multiplication of Decimal Numbers.  
**Topic:** Operation of Decimal Numbers x Decimal Numbers  
**Lesson No:** 3/3

**MT:** Let's compare the size and understand the relationship between the product and the multiplier in the multiplication of decimal numbers smaller than 1.

**Review**

**MT:** Introduce the main task here.

[6] There is a metal bar that weighs 3.1 kg per meter. What is the weight of 1.2m and 0.8m of this bar respectively?



Weight (kg)	?	3.1	?
Length (m)	0.8	1	1.2

**1** Let's find the weight of 1.2m metal.  
**Mathematical Expression:**  $3.1 \times 1.2$

3	1	
x	1	2
6		
3	1	
3		
3	7	2

Answer: 3.72 kg

**2** Let's find the weight of 0.8m metal.  
**Mathematical Expression:**  $3.1 \times 0.8$

3	1	
x	0	8
2		
2	4	8

Answer: 2.48 kg

**Important Point.**

[7] Put decimal points on the products and compare the products and the multiplicands.

$25$	$25$	$0.25$	$0.25$
$\times 6$	$\times 0.6$	$\times 6$	$\times 0.6$
150	15.0	1.50	0.150

**Exercise**

Let's multiply in vertical form.

Ⓐ  $8.2 \times 0.7 = 2.94$     Ⓑ  $6.8 \times 0.4 = 2.72$     Ⓒ  $0.8 \times 0.3 = 0.24$   
 Ⓓ  $2.17 \times 0.6 = 1.302$     Ⓔ  $0.14 \times 0.5 = 0.07$     Ⓕ  $0.07 \times 0.2 = 0.014$

**Summary**

\* When the multiplier is a decimal number smaller than 1, the product becomes smaller than the multiplicand.

\* When the multiplier is a decimal number larger than 1, the product is larger than the multiplicand.

Page 41

**Sub-unit Objective**

- To understand that commutative law and associative law can be applied in decimal numbers.

**Lesson Objective**

- To understand and apply commutative law and the associative law in calculating decimal numbers.

**Prior Knowledge**

- Multiplication of decimal numbers smaller than 1
- Commutative and Associative laws (Grades 3 and 4)

**Preparation**

- A diagram of a rectangle drawn in Task 1
- Chart of Calculation Rule (1)

**Assessment**

- Understand and apply commutative law and the associative law in calculating with decimal numbers. **F S**

**Teacher's Notes**

- In this lesson, students do not have to know the term “commutative” and “associative” laws but instead learn the process of applying the rules such as;
- Commutative law is when 2 numbers are multiplied or added even when their order is reversed, the product or sum is the same.
- Associative law is when 3 numbers are multiplied or added, the order of calculation does not change the product or sum.

**Commutative Law in multiplication of decimal numbers**  
**Rules for Calculation**

- 1 Vavi and Kekeni calculated the area of the rectangle on the right. Compare their answers.

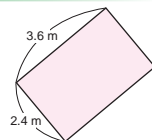

**Vavi's Idea**  
 $3.6 \times 2.4 = 8.64 \text{ (m}^2\text{)}$

**Kekeni's Idea**  
 $2.4 \times 3.6 = 8.64 \text{ (m}^2\text{)}$

**Associative Law in multiplication and addition of decimal numbers**

- 2 Problems A and B were calculated easily. Explain the reason why the right hand side methods are appropriate.

A  $3.8 + 2.3 + 2.7 \rightarrow 3.8 + (2.3 + 2.7)$

B  $1.8 \times 2.5 \times 4 \rightarrow 1.8 \times (2.5 \times 4)$

**Calculation Rule (1)**

- Addition**
- When 2 numbers are added, the sum is the same even if the order of the numbers added is reversed.  
 $\blacksquare + \blacktriangle = \blacktriangle + \blacksquare$  **Commutative Law**
  - When 3 numbers are added, the sum is the same even if the order of addition is changed.  
 $(\blacksquare + \blacktriangle) + \bullet = \blacksquare + (\blacktriangle + \bullet)$  **Associative Law**
- 
- Multiplication**
- When 2 numbers are multiplied, the product is the same even if the multiplicand and the multiplier are reversed.  
 $\blacksquare \times \blacktriangle = \blacktriangle \times \blacksquare$  **Commutative Law**
  - When 3 numbers are multiplied, the product is the same even if the order of multiplication is changed.  
 $(\blacksquare \times \blacktriangle) \times \bullet = \blacksquare \times (\blacktriangle \times \bullet)$  **Associative Law**

32 = □ × □

## Lesson Flow

### 1 Review the previous lesson.

### 2 Think about how to calculate the area of the rectangle.

- T/S** 1 Read and understand the situation.
- T** Introduce the Main Task. (Refer to the Blackboard Plan)
- T** Ask the students to find the area of the rectangle.
- S** Think about how to calculate the area of the rectangle and present their ideas.
- T** Compare students' ideas with Vavi's and Kekeni's ideas.
- TN** Vavi's Idea:  $3.6 \times 2.4 = 8.64$     Answer:  $8.64 \text{ m}^2$   
 Kekeni's Idea:  $2.4 \times 3.6 = 8.64$     Answer:  $8.64 \text{ m}^2$
- T** What did you notice from these two orders of calculations?
- S** Even when changing the order of calculation, the answer is still the same.

### 3 Think about how to use the rules of calculation in multiplication and addition.

- T/S** 2 Read and understand the situation.
- T** What do you think about the calculation on the right hand side for (A) and (B)?
- S** In both (A) and (B), the order of calculation is changed so that the answer in the bracket becomes a whole number as 5 and 10 respectively and makes the calculation more easier.

### 4 Calculation rule (1)

- T** Ask students to discuss and explain the calculation rule from the textbook or chart.
- S** Discuss and explain their ideas to their friends.
- T** Confirms the understanding of the calculation rule 1.
- TN** Students need to understand that the calculation rules apply to decimal numbers as well.

### 5 Summary

- T** What have you learned in this lesson?
- S** Present ideas on what they have learned.
- T** Use students' ideas to confirm the important concepts of this lesson.

## Sample Blackboard Plan

**Date:**  
**Chapter:** 3 Multiplication of Decimal Numbers.  
**Topic:** Rules for Calculation. **Lesson No:** 1/2

**MT:** Let's think about how to find an effective way for easier calculations.

**Review**

**MT:** Introduce the main task here.

[1] Vavi and Kekeni calculated the area of the rectangle on the right. Compare their answers.

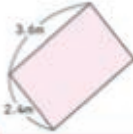

**Students' Ideas.**

Vavi's Idea  
 $3.6 \times 2.4 = 8.64 \text{ (m}^2\text{)}$

Kekeni's Idea  
 $2.4 \times 3.6 = 8.64 \text{ m}^2$

Even changing the order of calculation the answer is still the same.

[2] Problems (A) and (B) were calculated easily. Explain the reason why the right hand side methods are appropriate.

(A)  $3.8 + 2.3 + 2.7 \rightarrow 3.8 + (2.3 + 2.7)$   
 (B)  $1.8 \times 2.5 \times 4 \rightarrow 1.8 \times (2.5 \times 4)$

In both A and B the order of calculation is changed so that the operation in the brackets becomes a whole number as 5 and 10 respectively which makes the calculation easier.

Calculation Rule (1)

Addition

(i) When 2 numbers are added, the sum is the same even if the order of the numbers is reversed.  
 $a + b = b + a$

(ii) When 3 numbers are added, the sum is the same even if the order of addition is changed.  
 $(a + b) + c = a + (b + c)$

Multiplication

(i) When 2 numbers are multiplied, the product is the same even if the multiplicand and the multiplier are reversed.  
 $a \times b = b \times a$

(ii) When 3 numbers are multiplied, the product is the same even if the order of multiplication is changed.  
 $(a \times b) \times c = a \times (b \times c)$

**Summary**  
 \* The order of calculation for addition and multiplication with decimal numbers does not change the sum or product.

Page 27

**Lesson Objective**

- To understand that distributive law can be applied in the calculation of decimal numbers.

**Prior Knowledge**

- Multiplication of decimal numbers
- Distributive law in whole numbers (Grade 4)

**Preparation**

- Diagram representation of 3, 4 and 5
- Chart of Calculation Rule (2)

**Assessment**

- Make mathematical expression by observing the figure. **F**
- Calculate using distributive law. **F S**
- Solve the exercise correctly. **S**

**Teacher's Notes**

- In this lesson, students do not have to know the term "distributive" laws but instead learn the process of applying the rules.
- When using operations of addition and multiplication or subtraction and multiplication with brackets, expand the operation in the brackets before calculation.
- Consider the correct order of operations when calculating.

**Distributive Law 2 in the case of multiplication of decimal number**

3 The answer to  $1.4 \times 3$  can be calculated by thinking as follows. Let's explain the method by using this diagram.

$$1.4 \times 3 = (1 + 0.4) \times 3$$

$$= 1 \times 3 + 0.4 \times 3$$

$$\begin{array}{r} 1.4 \\ \times 23 \\ \hline 4.2 \end{array}$$

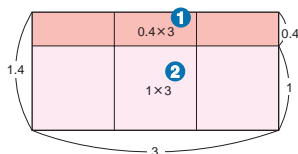

**Distributive Law 2 in the case of multiplication of decimal number**

4 The answer to  $1.8 \times 3$  can be calculated by thinking as follows. Let's explain the method by using this diagram.

$$1.8 \times 3 = (2 - 0.2) \times 3$$

$$= 2 \times 3 - 0.2 \times 3$$

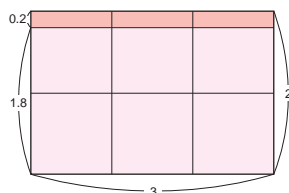

**Distributive Law**

**Calculation Rule (2)**

$$(\square + \triangle) \times \bullet = \square \times \bullet + \triangle \times \bullet$$

$$(\square - \triangle) \times \bullet = \square \times \bullet - \triangle \times \bullet$$

$\square - \square = 33$

5 Let's explain how the calculation rules are used for easier calculations.

1  $3.6 \times 2.5 \times 4$

$$= 3.6 \times (2.5 \times 4)$$

$$= 3.6 \times 10$$

$$= 36$$

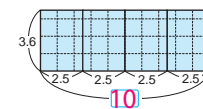

2  $7.2 \times 3.5 + 7.2 \times 6.5$

$$= 7.2 \times (3.5 + 6.5)$$

$$= 7.2 \times 10$$

$$= 72$$

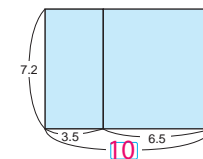

It is useful to remember the multiplications that have products such as 1 and 10.

$0.25 \times 4 = 1$      $1.25 \times 8 = 10$      $2.5 \times 4 = 10$

**Exercise**

Let's calculate using the calculation rules. Write down how you calculated.  $6.9 \times 10 = 69$      $3.8 \times (4.8 + 5.2) = 3.8 \times 10 = 38$

- ①  $6.9 \times 4 \times 2.5 = 69$     ②  $3.8 \times 4.8 + 3.8 \times 5.2 = 38$
- ③  $0.5 \times 4.3 \times 4 = 8.6$     ④  $3.6 \times 1.4 + 6.4 \times 1.4 = 14$

## Lesson Flow

### 1 Review the previous lesson.

### 2 Think about how to calculate $1.4 \times 3$

**T/S** 3 Read and understand the situation.

**T** Introduce the Main Task. (Refer to the BP)

**T** Ask students to explain the mathematical sentence by observing the figure.

**S** 1.4 is divided by 2 parts, 1 and 0.4. Calculated separately,  $1 \times 3$  and  $0.4 \times 3$

**S** When calculating the area separately, the whole area is 4.2

### 3 Think about how to calculate $1.8 \times 3$

**T/S** 4 Read and understand the situation.

**T** Ask students to explain mathematical sentences by observing the figure.

**S**  $1.8 = 2 - 0.2$  so  $1.8 \times 3 = (2 - 0.2) \times 3$

**S** When subtracting small area ( $0.2 \times 3$ ) from the large area ( $2 \times 3$ ), we can find the area ( $1.8 \times 3$ )

### 4 Calculation rule (2).

**T/S** Based on tasks 3 and 4, explain that calculation rule (2) can be applied in the calculation of decimal numbers.

### 5 Explain how calculation rule (2) is used.

**S** 1  $2.5 \times 4 = 10$ , so when calculating  $2.5 \times 4$  first, the whole calculation become easier.

**S** 2  $3.5 + 6.5 = 10$ , so when calculating  $3.5 + 6.5$  first, the whole calculation becomes easier.

### 6 Important Point

**T/S** Explain the important point in the box  

### 7 Complete the Exercise

**S** Solve the selected exercises.

**T** Confirm students' answers.

### 8 Summary

**T** What have you learned in this lesson?

**S** Present ideas on what they have learned.

**T** Use students' ideas to confirm the important concepts of this lesson.

## Sample Blackboard Plan

**Date:**  
**Chapter:** 3 Multiplication of Decimal Numbers.  
**Topic:** Rules for Calculation. **Lesson No:** 2/2

**Main Task:** Let's think about how distributive law is used for easier calculation.

**Review**

**MT:** Introduce the main task here.

[3] The answer to  $1.4 \times 3$  can be calculated by thinking as follows. Let's explain the method by using this diagram.

$$1.4 \times 3 = (1 + 0.4) \times 3$$

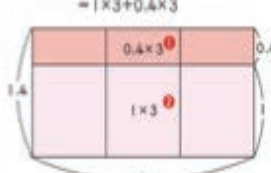
$$= 1 \times 3 + 0.4 \times 3$$

[4] The answer to  $1.8 \times 3$  can be calculated by thinking as follows. Let's explain the method by using this diagram.

$$1.8 \times 3 = (2 - 0.2) \times 3$$

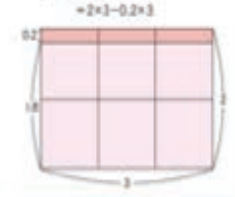
$$= 2 \times 3 - 0.2 \times 3$$

**Calculation Rule (2)**

①  $(a+b) \times c = a \times c + b \times c$

②  $a \times (b+c) = a \times b + a \times c$

**Important Point.**

**Exercise**

Let's calculate using the calculation rules. Write down how you calculated.

①  $6.9 \times 4 \times 2.5$   
 $6.9 \times 10 = 69$

②  $3.8 \times 4.8 + 3.8 \times 5.2$   
 $3.8 \times (4.8 + 5.2) = 3.8 \times 10 = 38$

③  $0.5 \times 4.3 \times 4$   
 $= 4.3 \times (0.5 \times 4)$   
 $= 4.3 \times 2$   
 $= 8.6$

④  $3.6 \times 1.4 + 6.4 \times 1.4$   
 $= 1.4 \times (3.6 + 6.4)$   
 $= 1.4 \times 10$   
 $= 14$

**Summary**

\* Refer to the Kapul for the summary.

# Unit 3

## Unit: Multiplication of Decimal Numbers Exercise, Problems and Evaluation Lesson 1 and 2 of 2

Textbook Page :  
035 and 036  
Actual Lesson 023 and 024

### Lesson Objective

- To confirm their understanding on the concepts they learned in this unit by completing the Exercise, Problems and the Evaluation Test confidently.

### Prior Knowledge

- All the contents covered in this unit

### Preparation

- Evaluation test copy for each student

### Assessment

- Complete the Exercise and Problems correctly. **S**

### Teacher's Notes

This is the last lesson of Chapter 3. Students should be encouraged to use the necessary skills learned in this unit to complete all the Exercises and solve the Problems in preparation for the evaluation test. The test can be conducted as assessment for your class after completing all the exercises. Use the attached evaluation test to conduct assessment for your class after finishing all the exercises and problems as a separate lesson.

### EXERCISE

1 Let's multiply in vertical form. Pages 29 to 33

- ①  $50 \times 4.3 = 215$    ②  $6 \times 1.8 = 10.8$    ③  $26 \times 3.2 = 83.2$    ④  $3 \times 1.4 = 4.2$   
 ⑤  $31 \times 5.2 = 161.2$    ⑥  $62 \times 0.7 = 43.4$    ⑦  $0.6 \times 0.8 = 0.48$    ⑧  $3.5 \times 0.9 = 3.15$   
 ⑨  $1.5 \times 3.4 = 5.1$    ⑩  $0.3 \times 0.25 = 0.075$    ⑪  $1.26 \times 2.3 = 2.898$    ⑫  $4.36 \times 1.5 = 6.54$

2 Let's find the area of the rectangle. Pages 33 and 34

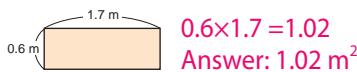

3 There is a wire that weighs 4.5 g per 1 m. Page 31

Let's find the weight of 8.6 m and the weight of 0.8 m of this wire.

$4.5 \times 8.6 = 38.7$    Answer: 38.7g    $4.5 \times 0.8 = 3.6$    Answer: 3.6g

4 Let's fill the  with equal or inequality signs. Page 31

- ①  $3.5 \times 3.5 > 3.5$    ②  $3.5 \times 0.1 < 3.5$   
 ③  $3.5 \times 0.9 < 3.5$    ④  $3.5 \times 1 = 3.5$

5 Choose numbers from the  below and make problems for multiplications of decimal numbers. Exchange your problems with your friends and solve. Page 34

1.5   7   0.8   30   2.3   5

Find the sizes of the following angles (A) to (D).

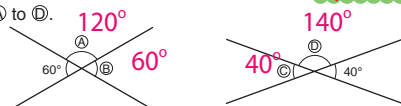

$\square - \square = 35$

### PROBLEMS

1 Summarize how to calculate with decimal numbers.

Understanding how to calculate with decimal numbers.

To calculate  $2.3 \times 1.6$  first multiply 2.3 by 10 and multiply 1.6 by 10, then calculate  $23 \times 16$  and then the answer is  $\frac{\square}{100}$  of 368.

2 Let's multiply in vertical form.

Multiplying decimal numbers in vertical form.

- ①  $28 \times 1.3 = 36.4$    ②  $19 \times 1.2 = 22.8$    ③  $3.2 \times 1.8 = 5.76$   
 ④  $0.4 \times 0.6 = 0.24$    ⑤  $3.5 \times 0.7 = 2.45$    ⑥  $7.6 \times 0.5 = 3.8$   
 ⑦  $2.87 \times 4.3 = 12.341$    ⑧  $1.08 \times 2.1 = 2.268$    ⑨  $0.07 \times 0.8 = 0.056$

3 There is a copper wire that costs 90 kina per 1 m.

Estimating the product with multipliers should be larger or smaller than 1.

- ① How much will it cost for 3.2 m?  $3.3 \times 90 = 288$    Answer: 288 toea / K2. 88  
 ② How much will it cost for 0.6 m?  
 $0.6 \times 90 = 54$    Answer: 54 toea

4 Let's calculate in easier ways. Show how you calculated.

Using the calculation rules.

- ①  $0.5 \times 5.2 \times 8 = 5.2 \times (8 \times 0.5) = 5.2 \times 4 = 20.8$   
 ②  $2.8 \times 15 = (3 - 0.2) \times 15 = 45 - 3 = 42$

5 Let's put decimal points on the products for the following calculations.

Using operations of decimal numbers  $\times$  decimal numbers

- ① 
$$\begin{array}{r} 0.15 \\ \times 2.8 \\ \hline 120 \\ 30 \\ \hline 420 \end{array}$$
   ② 
$$\begin{array}{r} 6.43 \\ \times 2.4 \\ \hline 2572 \\ 1286 \\ \hline 15432 \end{array}$$

## Lesson Flow

### 1 Complete the Exercise

- S Solve all the exercises.
- T Confirm students' answers.
- TN
  - ② Area of rectangle
  - ③ Word problems of decimal number
  - ④ Comparison of decimal numbers
  - ⑤ Making word problems of decimal numbers

### 2 Solve the Problems

- S Solve all the problems.
- T Confirm students' answers.
- TN
  - ① Explain how to multiply decimal number by decimal number.
  - ② Multiplication of decimal number in vertical form.

- ③ Understand the relation between product and 2<sup>nd</sup> number in the operation.
- ④ Apply commutative law and distributive law.
- ⑤ Explain the structure of multiplication of decimal number.

### 3 Complete the Evaluation Test

- TN Use the attached evaluation test to conduct assesment for your class after finishing all the exercises and problems as a seperate lesson.
- S Complete the Evaluation Test.

**End of Chapter Test:** **Date:** \_\_\_\_\_

Chapter 3: Multiplication of Decimal Numbers	Name: _____	Score / 100
---	-------------	----------------

[10 marks for each question]

1. Calculate .

(1)  $63 \times 2.4$

$$\begin{array}{r} 63 \\ \times 2.4 \\ \hline 252 \\ 362 \\ \hline 387.2 \end{array}$$

Answer: 387.2

(3)  $40 \times 0.37$

$$\begin{array}{r} 40 \\ \times 0.37 \\ \hline 280 \\ 120 \\ \hline 14.8 \end{array}$$

Answer: 14.8

(2)  $85 \times 4.02$

$$\begin{array}{r} 85 \\ \times 4.02 \\ \hline 4016 \\ 4016 \\ \hline 441.7 \end{array}$$

Answer: 441.7

(4)  $7.3 \times 8.2$

$$\begin{array}{r} 7.3 \\ \times 8.2 \\ \hline 146 \\ 584 \\ \hline 59.86 \end{array}$$

Answer: 59.86

2. The following calculations show the processes of making the calculations easy. Fill numbers in the  $\square$ . [20 marks for each question]

(1)  $2.5 \times 7.6 \times 4$

$$= (2.5 \times 4) \times 7.6$$

$$= 10 \times 7.6$$

$$= 76$$

(2)  $7.5 \times 4.6 \times 2.4$

$$= 7.5 \times (4.6 + 2.4)$$

$$= 7.5 \times 7$$

$$= 52.5$$

3. Answer the following questions. [10 marks for mathes expression and 10 marks for answer]

(1) What is the area of a rectangle whose length is 4.5 m and width is 8.02 m?

Mathematical Expressions:

$4.5 \times 8.02$

Answer:

$32.481 \text{ m}^2$

**End of Chapter Test**

**Date:**

Chapter 3: Multiplication of Decimal Numbers	Name:	Score / 100
---	-------	----------------

1. Calculate.

[10 marks for each question]

(1)  $63 \times 2.4$

(2)  $85 \times 4.02$

Answer:

Answer:

(3)  $40 \times 0.37$

(4)  $7.3 \times 8.2$

Answer:

Answer:

2. The following calculations show the processes of making the calculations easy.

Fill numbers in the .

[20 marks for each question]

(1)  $2.5 \times 7.6 \times 4$

$= (\text{ } \times 4) \times \text{ }$

$= \text{ } \times 7.6$

$= \text{ }$

(2)  $7.5 \times 4.6 \times 2.4$

$= 7.5 \times (\text{ } + \text{ } )$

$= 7.5 \times 7$

$= \text{ }$

3. Answer the following questions.

[10 marks for maths expression and 10 marks for answer]

(1) What is the area of a rectangle with length is 4.5 m and width is 8.02 m?

Mathematical Expressions:

Answer:



# Chapter 4 Congruence and Angles of Figures

## 1. Content Standard

5.3.1 Investigate and understand the properties of congruent triangles and quadrilaterals.

## 2. Unit Objectives

- To deepen students' understanding of plane geometrical figures through observing and composing figures.
- To understand congruence of geometrical figures.

## 3. Teaching Overview

Students already learned that figures are categorised by their elements.

They also learned that they can draw specific figures by paying attention to the features of each element. In this unit, students observe figures by the perspective of congruency.

### **Congruent Figures :**

Students understand that two congruent figures can fit exactly on top of each other.

They learn that congruent figures can be identified by minimum conditions.

They also learn that they can draw congruent figures by the minimum conditions given.

Note that they should be given enough opportunity for constructions.

### **Angles of Triangles and Quadrilaterals :**

First, students focus on the interior angles of a triangle and their sum.

Then they expand the knowledge on the sum of interior angles of quadrilaterals and other polygons.

## 4. Related Learning Contents

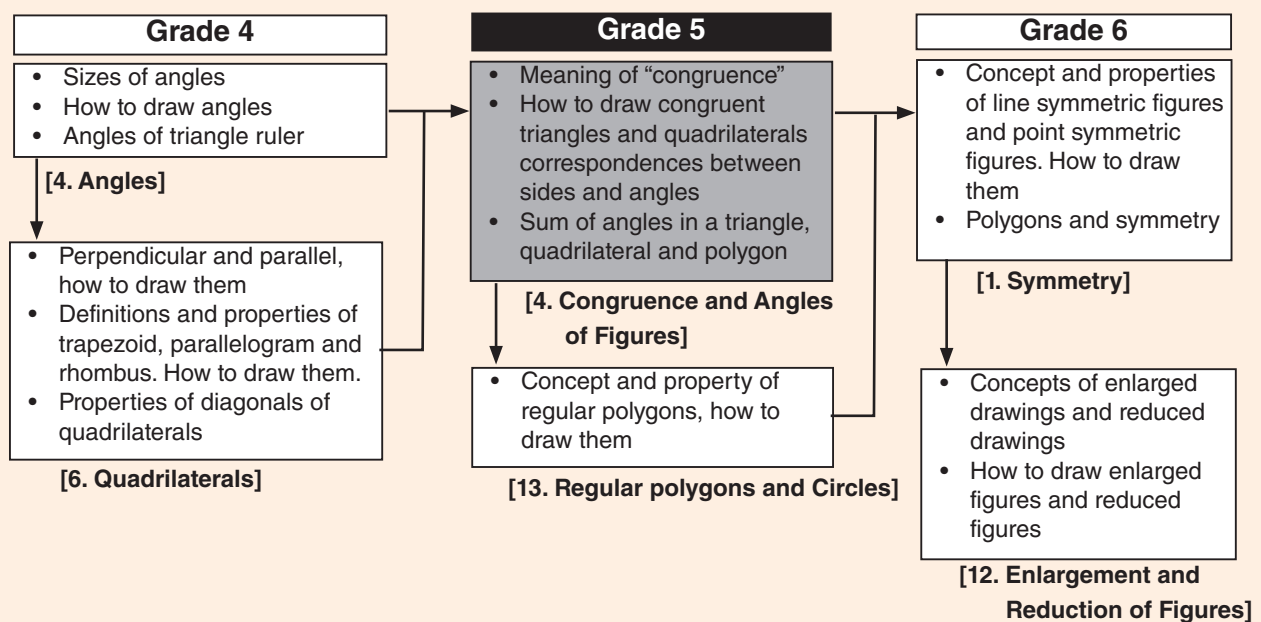

**Sub-unit Objectives**

- To understand the meaning of congruence.
- To understand how to draw a congruent triangle and a congruent quadrilateral.
- To understand the term corresponding.

**Lesson Objectives**

- To understand and define the meaning of congruent.
- To think about the properties that determine congruency of plane figures.

**Prior Knowledge**

- Rectangles, squares and right triangles (Grade 3)
- Perpendicular lines, parallel lines and quadrilaterals (Grade 4)
- Angles (Grade 4)

**Preparation**

- Protractor, compass and 1 cm grid sheets.

**Assessment**

- Draw a congruent triangle by using a compass and a protractor. **F**
- Explain the meaning of congruent. **S**

**Teacher's Notes**

When two geometrical figures overlap each other and have the same shape and size, they are congruent. The corresponding side lengths and corresponding angle sizes are the same.

Students should be able to determine and verify the properties of geometrical figures through activities such as finding, drawing and constructing congruent geometrical figures.

**4**

**Congruence and Angles of Figures**

▶▶ Is it possible to tell the shape only by words?  
 Joyce drew a triangle on a 1 cm grid sheet.  
 In order for her friends to draw the same figure,  
 she is explaining the shape only by words on the board.

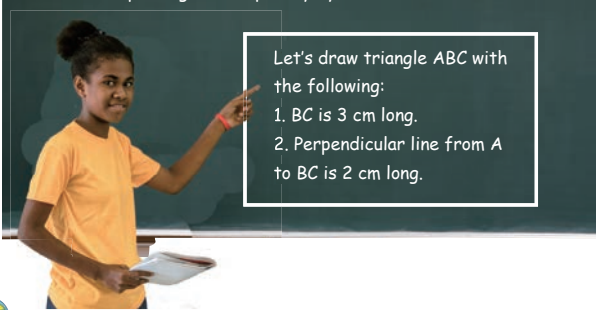

Let's draw triangle ABC with the following:  
 1. BC is 3 cm long.  
 2. Perpendicular line from A to BC is 2 cm long.

What kinds of triangle can you draw from Joyce's explanation?

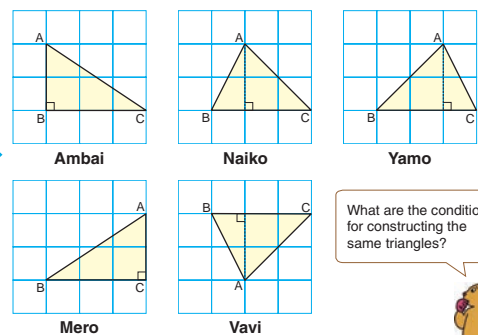

Naiko's, Yamo's and Vavi's triangles

What are the conditions for constructing the same triangles?



- 1 Let's think about how to use a compass and a protractor to draw a triangle congruent to triangle ABC.

**Using compass and protractor to draw congruent triangles**



I drew the same line as BC.

Now we need to determine the position of point A.



Two figures are congruent if they fit by lying on top of one another.

**Thinking about how to draw a congruent triangles**

**1 Congruent Figures**

- 1 Let's think about how to draw a triangle congruent to triangle ABC as shown on the right.

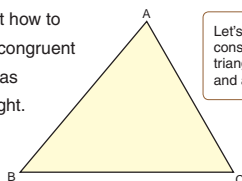

Let's think about constructing a congruent triangle with a compass and a protractor.



Let's explore how to draw congruent figures and their properties.

## Lesson Flow

### 1 Understand the term congruence and its meaning.

- T** Introduce the Main Task. (Refer to the BP)
- S** ▶▶ Discuss the situation on the blackboard and draw a triangle using the given instructions on the 1 cm grid paper.
- S** Compare the triangles drawn with other members of the class and the examples on page 38.
- T** Can the same triangle be drawn using the same instructions?
- S** Explain that some triangles are exactly the same but not all triangles are exactly alike.
- T** Select two triangles that are exactly alike and inform the students that these triangles are congruent.
- S** Explain the term congruent based on their observation of the 2 triangles shown.

### 2 Important Point

- T/S** Explain the important point in the box  .

### 3 1 Think about how to draw a triangle congruent to triangle ABC shown.

- T** How can we draw a triangle congruent to triangle ABC?
- S** Explain in groups how to draw a triangle congruent to ABC.
- TN** Ask students' to think about how to use the compass and protractor to construct the triangle.
- S** 1 Investigate and think about using a protractor and compass to determine the exact position of point A, when points B and C are given.

### 4 Discuss how to locate point A.

- S** 2 Discuss and identify how point A can be located using a protractor or compass.
- T** Which sides and angles and how many sides and angles did you use?
- S** Share ideas with the class on how to draw triangles congruent to triangle ABC.

### 5 Summary

- T** What have you learned in this lesson?
- S** Present ideas on what they have learned.
- T** Use students' ideas to confirm the important concepts of this lesson.

**2** Let's discuss how to locate point A to draw a triangle congruent to triangle ABC.

Which sides and angles did you use?

How many sides and angles did you use?

**3** If you know angle C and the length of sides AB and BC, then you can draw triangle ABC easily.

You drew two different triangles, didn't you?

**4** Let's summarise how to draw a congruent triangle.

### Sample Blackboard Plan

Lesson 025 Sample Blackboard Plan is on page 53.

Lesson Objective

- To understand how to draw congruent triangles.

Prior Knowledge

- Perpendicular lines, parallel lines and quadrilaterals (Grade 4)
- Angles (Grade 4)
- How to draw congruent triangle

Preparation

- Protractor and compass

Assessment

- Investigate and explain how to draw a triangle congruent to triangle ABC. **F**
- Draw a congruent triangle by using the properties of the side lengths and angles. **F S**

Teacher's Notes

When drawing a congruent triangle, consider the ideas discussed in Yamo's, Sare's and Ambai's ideas to get a better understanding of how to draw congruent triangles using a protractor and compass. These ideas highlight the importance of having exactly the same corresponding side lengths and angles.

2 Let's discuss how to locate point A to draw a triangle congruent to triangle ABC.

Write down students ideas here.

Which sides and angles did you use?

How many sides and angles did you use?

3 If you know angle C and the length of sides AB and BC, then you can draw triangle ABC easily.

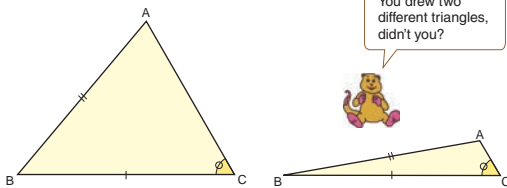

Concluding way of drawing a congruent triangle

4 Let's summarise how to draw a congruent triangle.

Let's explain.

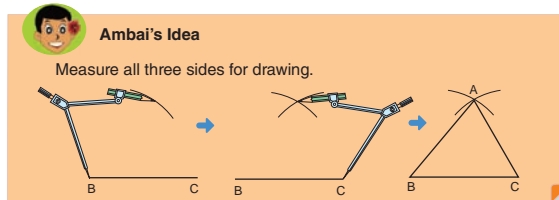
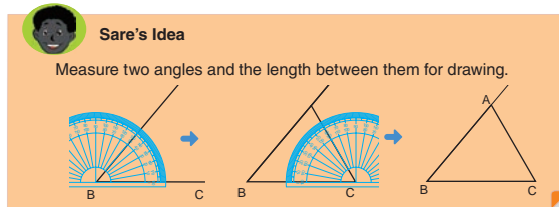
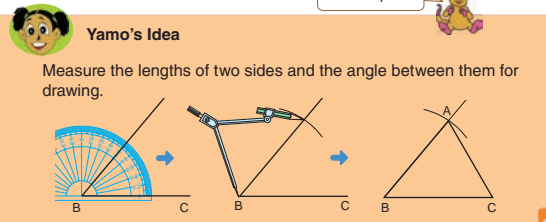

Drawing a congruent triangle

5 Let's draw a triangle congruent to triangle ABC as shown on the right.

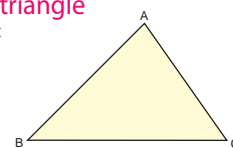

## Lesson Flow

**1** Review the previous lesson.

**2** **3** Compare two different triangles where 2 side lengths and 1 angle is given.

- T** Introduce the Main Task. (Refer to the BP)
- TS** Discuss and confirm that knowing 2 sides (AB) and (BC), and 1 angle (C) is not enough to determine the congruency of triangles.
- T** Why aren't these triangles congruent?
- S** Explain that side (AC) of both triangles are different in length.

**3** Summarise how to draw a congruent triangle.

- S** **4** Discuss some specific ways of drawing congruent triangles.
- S** Practice drawing congruent triangles using compasses and protractors using Yamo's, Sare's and Ambai's ideas.

**TN** Remind the students to use the compass and protractor correctly when constructing triangles.

**4** Draw a triangle congruent to triangle ABC.

- S** **5** Draw triangles congruent to triangle ABC using the three ideas to get a better understanding of how to draw congruent triangles in various ways.
- T** Allow the students to present their drawings and briefly explain how they drew their congruent triangles.

**5** Summary

- T** What have you learned in this lesson?
- S** Present ideas on what they have learned.
- T** Use students' ideas to confirm the important concepts of this lesson.

### Sample Blackboard Plan (Lesson 25)

**Date:**  
**Unit:** Congruence and Angles of Figures  
**Sub-unit:** 1. Congruent Figures

**MT:** Let's think and explain how to draw a triangle congruent to triangle ABC using compass and protractors.

► Discuss Joyce situation and answer the questions below.  
 Let's draw triangle ABC with the following:  
 1. BC is 3cm long.  
 2. Perpendicular line from A to BC is 2cm long.

What kinds of triangle can you draw from Joyce's explanation?  
 Display students' drawings and compare with below.  
 Tati, Yamo and Vavi's triangles.

Ambai

Tati

Yamo

**Two figures are congruent if they fit by lying on top of one another.**

**Congruent Figures**

**1** Let's think about how to draw a triangle congruent to triangle ABC.

**2** Let's think about how to use a compass and a protractor to draw a triangle congruent to triangle ABC. Complete drawing.

**3** Let's discuss how to locate point A.

**Possible ways to determine point A:**

Measure 3 sides with compass to determine point A from point B & C.

Measure 2 sides and their angle (vertex)

**B**

Measure the 2 angles of vertex B and C from line BC.

**C**

Measure 3 sides AB, AD & BD and confirm that line AD is perpendicular (90°) to line BC.

**D**

**Summary**  
 Two figures are congruent if they fit exactly on one another with all corresponding sides and angles equal.

P 53

### Sample Black Board Plan (Lesson 26)

**Date:**  
**Unit:** Congruence and Angles of Figures  
**Sub-unit:** 1. Congruent Figures

**Review**

**3** If you know angle C and the lengths of AB and BC. Let's draw triangle ABC.

**MT:** Let's think about how to draw congruent triangles.

The two figures are not congruent.

**4** Let's explain how to draw a congruent triangle.

**Yamo's idea:** Measure the lengths of two sides and the angle between them for drawing.

**Sare's idea:** Measure two angles and the lengths between them for drawing.

**Ambai's idea:** Measure all three sides for drawing.

**5** Let's draw a triangle congruent to triangle ABC.

**Summary**  
 Congruent triangles can be drawn accurately using protractors and compasses.

Lesson Objectives

- To understand the meaning of the term correspond.
- To understand the characteristics of edges and angles in congruent figures.

Prior Knowledge

- Perpendicular lines, parallel lines and quadrilaterals (Grade 4)
- Angles (Grade 4)
- How to draw congruent triangles

Preparation

- Protractor, compass and ruler

Assessment

- Compare and measure the length and size of corresponding sides and angles in congruent triangles. **F**
- Understand the characteristics of congruent figures. **S**

Teacher's Notes

- When two matching geometrical figures overlap each other having the same shape and size, they are congruent. The corresponding side lengths and corresponding angle sizes are the same.
- Students should be able to determine and verify the properties of geometrical figures through activities such as finding, drawing and constructing congruent geometrical figures.

2 Triangle DEF below is the reverse of triangle ABC.

Confirm that triangle DEF is the reverse of triangle ABC.

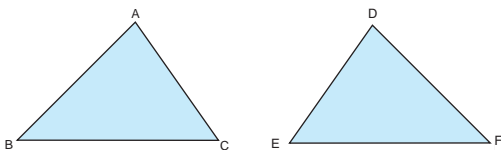

The meaning of congruent figures

1 Let's confirm whether the two triangles match when they fit by lying on one another.



Two figures are also congruent if they match by reverse. In congruent figures, the matching points, the matching sides and the matching angles are called: **corresponding vertices, corresponding sides and corresponding angles**, respectively.

2 In the above triangles ABC and DEF, find the corresponding sides and compare the lengths.

3 Find the corresponding angles and compare their sizes.



In congruent figures, the corresponding sides are equal in length and the corresponding angles are also equal in size. Congruent figure is a figure which is identical in shape, size and angles.

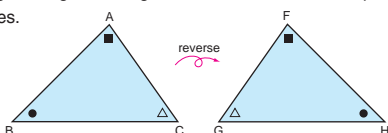

Concluding the characteristics of congruent triangles

**Congruent Triangle** Put the title on top for showing what topic you learned.

**Date** Don't forget to write the date.

1 Findings

- Two figures are congruent if they fit by lying on top of one another.
- There are three ways for drawing a congruent triangle. The diagrams on the right shows the place for measuring.
- Two triangles are also congruent if they match by flipping over.
- Compass can be used as a tool to copy the same lengths.
- Matching sides and angles are called **corresponding sides** and **'corresponding angles'**, respectively.

2 Interesting points

- The rotated or reversed figure is also congruent.
- There are three conditions for congruence between two triangles. Are there four conditions for quadrilaterals?
- It is interesting that two triangles with all three equal angles are not always congruent.

3 What was difficult

- Finding corresponding sides and angles when the figure is reversed.

4 Good ideas from Friends

- Ambai's idea for drawing a congruent triangle requires only a compass and does not need to measure angles.

If you recognised good ideas from your friends, write them down.

## Lesson Flow

**1** Review the previous lesson.

**2** Investigate triangle ABC and DEF to confirm that one is the reverse of the other.

**T** Introduce the Main Task. (Refer to the Blackboard Plan)

**S** **1** Do the activity by tracing Triangle ABC and placing it over triangle DEF.

**T** Are they congruent?

**S** Recognise that the triangles fit exactly on top of each other.

**T** Confirm through demonstration.

**3** Important Point

**T/S** Explain the important point in the box  .

**4** Identify and compare the lengths of corresponding sides in triangle ABC and DEF.

**S** Measure and compare the lengths of corresponding sides and briefly explain.

**T** Confirm that corresponding sides are equal in length.

**5** Identify and compare the sizes of corresponding angles in triangle ABC and DEF.

**S** Measure and compare the sizes of corresponding angles and briefly explain.

**T** Confirm that corresponding angles are equal in size.

**6** Important Point

**T/S** Explain the important point in the box  .

**7** Summary

**T** What have you learned in this lesson?

**S** Present ideas on what they have learned.

**T** Use students' ideas to confirm the important concepts of this lesson.

### Sample Blackboard Plan

**Date:**  
**Unit:** Congruence and Angles of Figures  
**Sub-unit:** 1. Congruent Figures

**Review**

**2** Triangle DEF is the reverse of triangle ABC.

**MT:** Let's compare corresponding vertices, sides and angles in congruent triangles.

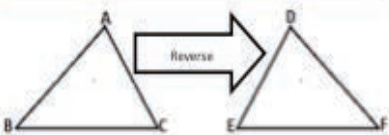

**1** Let's confirm whether the two triangles match when they fit by lying on one another.

Two figures are also congruent if they match by reverse. In congruent figures, the matching points, the matching sides and the matching angles are called; **corresponding vertices, corresponding sides and corresponding angles, respectively.**

**3** In the above figures; triangle ABC is congruent to triangle DEF. Name the corresponding sides and compare the lengths of the corresponding sides.

Corresponding sides:

- BC and EF
- AB and DF
- AC and DE

When comparing all the corresponding sides the lengths of the corresponding sides are equal.

**3** Name the corresponding angles and compare their sizes.

Corresponding angles:

- A and D
- B and F
- C and E

When comparing all the corresponding angles the size of the corresponding angles are equal.

In congruent figures, the corresponding sides are equal in length and the corresponding angles are also equal in size.



**Congruent Triangles**

**1. Definition.**

- Two figures are congruent if they fit by lying on top of one another.
- There are three ways for drawing a congruent triangle. The diagrams on the right show the ways for drawing.
- Two triangles are also congruent if they match by fitting over.
- Concave can be used as a tool to copy the same lengths.
- Matching sides and angles are called 'corresponding sides' and 'corresponding angles', respectively.

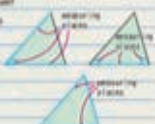

**2. Congruence rules.**

- Two related or identical figures are also congruent.
- There are three conditions for congruence between two triangles. See these four conditions for quadrilaterals.
- It is interesting that two triangles with all three equal angles are not always congruent.



**3. The use of paper.**

- Placing corresponding sides and angles when the figure is reversed.

**4. Use of the compass.**

- What's idea for drawing a congruent triangle requires only a compass and does not need to measure angles.

**Summary**

Two congruent triangles have matching points, sides and angles called corresponding vertices, sides and angles.

55

### Lesson Objective

- To understand how to draw a congruent quadrilateral.

### Prior Knowledge

- Perpendicular lines, parallel lines and quadrilaterals (Grade 4)
- Angles (Grade 4)
- Drawing congruent triangles

### Preparation

- Protractor, compass and ruler

### Assessment

- Investigate and explain how to draw a quadrilateral congruent to quadrilateral ABCD. **F S**
- Draw a congruent quadrilateral by using the properties of the side lengths and angles. **F S**

### Teacher's Notes

Students should be able to determine and verify the properties of geometrical figures through activities such as finding, drawing and constructing congruent geometrical figures. In this lesson, students will be able to build on what they have learned on drawing congruent triangles from lesson #2 by using a compass, protractor and ruler to draw figures.

#### Congruent Quadrilaterals

#### Thinking about how to draw a congruent quadrilateral

- 3 Let's think about how to draw a quadrilateral which is congruent to quadrilateral ABCD as shown on the right.

Can we adopt the way on how to draw a congruent triangle?

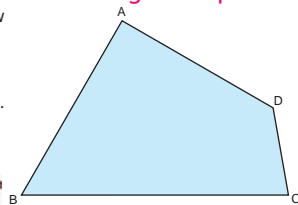

- 1 If you measure four sides of the quadrilateral for drawing, can you draw a congruent quadrilateral?



I measured the four sides and drew but I got various shapes.

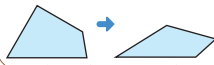

Using the diagonal, I split the quadrilateral into two triangles.

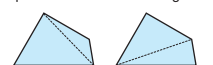

#### Concluding the way on how to draw a congruent quadrilateral

- 2 Let's discuss how to draw a congruent quadrilateral with your friends. How can we locate the fourth point?



#### Mero's Idea

Measure angles A and C and determine point D.

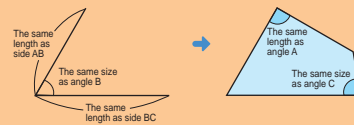

#### Keken's Idea

Use Ambai's idea (page 41) for drawing a congruent triangle to determine point D on quadrilateral. Measure sides AD and CD.

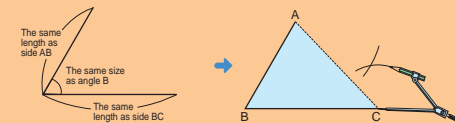

#### Naiko's Idea

Use Sare's idea (page 41) for drawing a congruent triangle to determine point D on quadrilateral. Measure angles which are subtended by diagonals AC and sides.

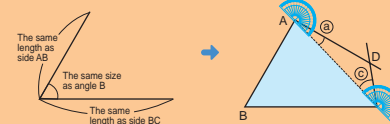

- 3 Use the ideas above to draw a congruent quadrilateral for quadrilateral ABCD.



## Lesson Flow

**1** Review the previous lesson.

**2** Investigate quadrilateral ABCD and discuss how to draw a quadrilateral congruent to ABCD.

**T** Introduce the Main Task. (Refer to the BP)

**TS** **3** Read and understand the situation.

**S** **1** Measure the four sides of quadrilateral ABCD and draw a quadrilateral congruent to ABCD using the length of sides.

**T** Are they congruent?

**S** Find out that drawing using the side lengths will not result in a quadrilateral congruent to ABCD like triangles.

**3** Discuss how to draw congruent quadrilaterals.

**T** **2** Discuss how you can draw a quadrilateral congruent to ABCD.

**S** Discuss the possibility of dividing the quadrilaterals into 2 triangles or using angles.

**TS** Explain how the three ideas are used to draw congruent quadrilaterals.

I. Mero's Idea:

Measure angles A and C and extend the lines to determine point D.

II. Kekeni's Idea:

Split the quadrilateral into 2 triangles and use a compass to determine point D from points A and C.

III. Naiko's Idea:

Split the quadrilateral into 2 triangles and measure the angle from diagonal AC to determine point D.

**T** Ask the students to try out the ideas discussed to draw a quadrilateral congruent to ABCD.

**S** **3** Draw a congruent quadrilateral using the ideas discussed.

**4** Draw a congruent quadrilateral.

**S** **4** Draw a quadrilateral congruent to the one in the textbook by applying the ideas learned.

**5** Summary

**T** What have you learned in this lesson?

**S** Present ideas on what they have learned.

**T** Use students' ideas to confirm the important concepts of this lesson.

### Drawing a congruent quadrilateral

**4** Let's draw a congruent quadrilateral to the one shown below.

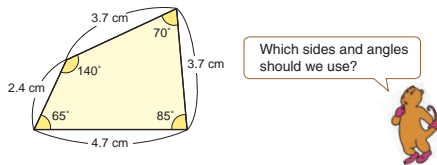

**5** The two quadrilaterals below are congruent. Describe the corresponding vertices, sides and angles.

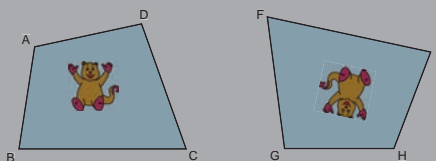

**1** The corresponding vertex to A is H. Write down in your exercise book the other corresponding vertices.

**2** The corresponding side to AB is HI. Write down in your exercise book the other corresponding sides.

**3** The corresponding angle to A is H. Write down in your exercise book the other corresponding angles.

46 = □ × □

### Sample Blackboard Plan

Lesson 028 Sample Blackboard Plan is on page 59.

# Unit 4

## Unit: Congruence and Angles of Figures Sub-unit 1: Congruent Figures Lesson 5 of 5

Textbook Page :  
046  
Actual Lesson 029

### Lesson Objective

- To identify and confirm that pairs of vertices, sides and angles in congruent quadrilaterals correspond to each other.

### Prior Knowledge

- Perpendicular lines, parallel lines and quadrilaterals (Grade 4)
- Angles (Grade 4)
- Drawing congruent triangles and quadrilateral

### Preparation

- Protractor, compass and ruler

### Assessment

- Investigate and identify corresponding vertices, sides and angles in congruent figures. **F**
- Identify congruent quadrilateral by using their properties. **S**

### Teacher's Notes

Students should be able to determine and verify the properties of congruent figures through activities of investigating congruency by comparing corresponding vertices, sides and angles.

In congruent figures, all corresponding vertices, side lengths and angles are equal either in length or size.

4 Let's draw a congruent quadrilateral to the one shown below.

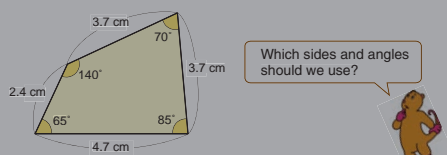

5 The two quadrilaterals below are congruent. Describe the corresponding vertices, sides and angles.

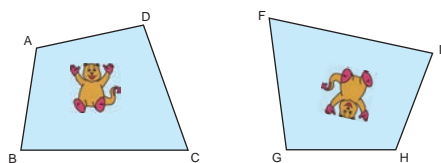

1 The corresponding vertex to A is H.  
Write down in your exercise book the other corresponding vertices.

**D is G, B is I and C is F**

2 The corresponding side to AB is HI.  
Write down in your exercise book the other corresponding sides.

**BC is IF, CD is FG and AD is GH**

3 The corresponding angle to A is H.  
Write down in your exercise book the other corresponding angles.

**Angle B corresponds to angle I  
Angle C corresponds to angle F  
Angle D corresponds to angle G**

46 = □ × □

## Lesson Flow

**1** Review the previous lesson.

**2** Investigate quadrilateral ABCD and FGHI and identify the properties that make them congruent.

**TS** **5** Read and understand the situation.

**T** Introduce the Main Task. (Refer to the BP)

**T** **1** Allow the students to identify the corresponding vertices on both quadrilaterals.

**S** D is G, B is I and C is F.

**3** **2** Investigate and identify the corresponding sides of quadrilateral ABCD and FGHI.

**T** Allow the students to identify the corresponding sides of both quadrilaterals.

**S** BC is IF, CD is FG and AD is GH.

**4** **3** Investigate and identify the corresponding angles of quadrilateral ABCD and FGHI.

**T** Allow the students to identify the corresponding angles of both quadrilaterals.

**S** Angle B corresponds to Angle I, Angle C corresponds to Angle F and Angle D corresponds to Angle G.

**5** Summary

**T** What have you learned in this lesson?

**S** Present ideas on what they have learned.

**T** Use students' ideas to confirm the important concepts of this lesson.

## Sample Blackboard Plan (Lesson 28)

**Date:**  
**Unit:** Congruence and Angles of Figures  
**Sub-unit:** 1. Congruent Figures

**Review**

**3** Let's think about how to draw a quadrilateral which is congruent to quadrilateral ABCD as shown.

**MT:** Let's think about and explain how to draw a congruent quadrilateral.

**1** If you measure four sides of the quadrilateral for drawing, can you draw a congruent quadrilateral?

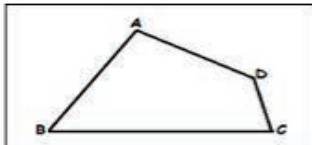

Lengths of sides will be the same but not congruent to ABCD.  
(Individual drawings will vary.)

**2** How can we locate the fourth point (D)?  
Refer to the three ideas in the text book for explanation.

**3** Use the three ideas to draw a congruent quadrilateral to quadrilateral ABCD.  
Individual drawings using the three ideas.

**4** Draw the congruent quadrilateral to the one shown in the text book.



**Summary**

Congruent quadrilaterals can be drawn using:

- side, angle, side
- angle, angle, angle
- side, side, side
- angle, side, angle

## Sample Blackboard Plan (Lesson 29)

**Date:**  
**Unit:** Congruence and Angles of Figures  
**Sub-unit:** 1. Congruent Figures

**Review**

**5** The two quadrilaterals are congruent. Describe the corresponding vertices, sides and angles.

**MT:** Let's investigate congruent Quadrilaterals by identifying their corresponding vertices, sides and angles.

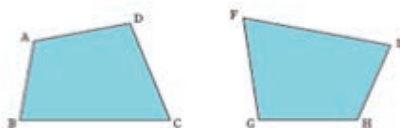

**1** The corresponding vertex to A is H.

**Other corresponding Vertices.**  
Vertex B and I  
Vertex C and F  
Vertex D and G

**2** The corresponding side to AB is HI.

**Other corresponding Sides.**  
Side BC and FI  
Side CD and FG  
Side AD and GH

**3** The corresponding angle to A is H.

**Other corresponding Angles.**  
Angle B and I  
Angle C and F  
Angle D and G

**SUMMARY**

We can say that two quadrilaterals are congruent when their pair of corresponding vertices, sides and angles are equal in size or length.

# Unit 4

## Unit: Congruence and Angles of Figures Exercise Lesson 1 of 1

Textbook Page :  
047  
Actual Lesson 030

### Lesson Objective

- To confirm what students learned about congruent figures.

### Prior Knowledge

- All the contents covered in sub-unit 1

### Preparation

- Enlarged diagrams of figures given in the Exercise

### Assessment

- Solve the exercises correctly. **F S**

### Teacher's Notes

- Refer students' to the sub-unit 1 content of this unit as their reference to complete the exercises.

## EXERCISE

- 1 Let's draw a congruent triangle with the following conditions. Pages 39 and 40

- ① A triangle with sides 4 cm, 7 cm and 8 cm.
- ② A triangle with sides 5 cm, 8 cm and an angle of  $75^\circ$  between them.
- ③ A triangle with angles  $45^\circ$ ,  $60^\circ$  and a side with 6 cm between them.
- ④ Triangles a) and b)

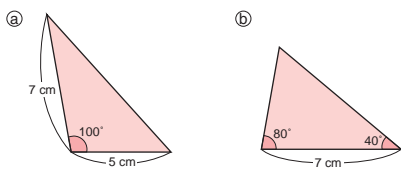

- 2 Let's draw a congruent quadrilateral to the one on the right. Pages 44 and 45

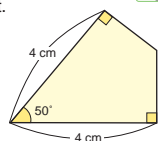

Let's calculate.

- |               |               |               |
|---------------|---------------|---------------|
| ① $120 + 60$  | ② $243 + 29$  | ③ $684 + 55$  |
| ④ $254 + 523$ | ⑤ $675 + 167$ | ⑥ $493 + 728$ |
| ⑦ $180 - 70$  | ⑧ $383 - 47$  | ⑨ $742 - 68$  |
| ⑩ $947 - 816$ | ⑪ $657 - 219$ | ⑫ $526 - 338$ |

Grade 4  
Do you remember?

## Lesson Flow

### 1 Complete the Exercise

**S** Solve all the exercises.

**T** Confirm students' answers.

**TN** ① Make sure the students fully understand each of the properties given from (1) to (4) before drawing the congruent of the triangles mentioned.

**TN** ② Guide the students in drawing the congruent of the figure.

The students can use rulers, protractors and compass for this exercise.

## Sample Blackboard Plan (Lesson 31)

**Date:**  
**Unit:** Congruence and Angles of Figures  
**Sub-unit:** 2. Angles of Triangles and Quadrilaterals.

① Let's explore the sum of two angles excluding the right angle.

**MT:** Let's investigate the angles in triangles..

The sum of the two angles are:  
 A.  $45^\circ + 45^\circ = 90^\circ$   
 B.  $30^\circ + 60^\circ = 90^\circ$

In the right triangle we are going to move vertex B toward C.

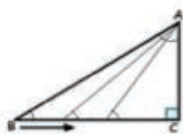

- ① How does the value of angle B change?  
*Vertex B will increase in angle size.*
- ② How does the value of angle A change?  
*Vertex A will decrease in angle size.*
- ③ Is there any relationship between the in angle B and angle A?  
*As vertex B increases, A decreases in angle size.*
- ④ Look at the change in the sum of angle A and angle B.

Angle A (degrees)	60	50	40	30	20	10
Angle B (degrees)	30	40	50	60	70	80
Sum (degrees)	90	90	90	90	90	90

From the table above, what did you find about the sum of the three angles in the right triangle?  
*The sum is always equal to  $180^\circ$ .*

- ② Look at the sum of the 3 angles of a triangle in various ways.

(1) Draw a triangle and measure the angles with a protractor.  
 The sum of the 3 angles is  $180^\circ$ .



- (2) Cut out the 3 angles and place them together as shown below.



Since the 3 angles together make a straight line, the sum of these angles is  $180^\circ$ .

- (3) Put together triangles with the same shape and size to make a continuous pattern without any gaps.



Since 3 angles at points A and B make a straight line, their sums are  $180^\circ$ .

- (4) Fold a triangle to connect the 3 angles.



Since the 3 angles make a straight line, the sum is  $180^\circ$ .

#### Summary

In any triangles, sum of the three angles is  $180^\circ$ .

### Sub-unit Objectives

- To understand that the sum of the three angles in any triangle as  $180^\circ$ .
- To find the sum of interior angles in other polygons based on the sum of interior angles of a triangle.

### Lesson Objective

- To understand that the sum of 3 angles in any triangle is  $180^\circ$  regardless of their shapes and sizes.

### Prior Knowledge

- Quadrilaterals and triangles.
- Perpendicular lines, parallel lines and quadrilaterals.
- Angles. (Grade 4)

### Preparation

- Protractor, compass and ruler, papers for 2.

### Assessment

- Investigate the angle sum of various types of triangles. **F**
- Explain various ways to show that the angle sum of triangles are  $180^\circ$ . **S**

### Teacher's Notes

The angle sum of a triangle is  $180^\circ$ .

Example:

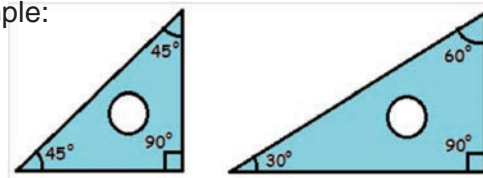

The angle sum of the set squares will be

$$(A) 45 + 45 + 90 = 180^\circ$$

$$(B) 30 + 60 + 90 = 180^\circ$$

### 2 Angles of Triangles and Quadrilaterals

#### 1 Understanding the angles in a triangle

Let's explore the sum of two angles excluding the right angle.

The sum of the two angles are;

**A**  $90^\circ$

**B**  $90^\circ$

In the right triangle below, we are going to move vertex B toward C.

1 How does the value of angle B change?

2 How does the value of angle A change?

3 Is there any relationship between the changes in angle B and angle A?

Angle B increases the same amount of that reduced in angle A. ( $10^\circ$ )

4 Look at the change in the sum of angle A and angle B.

Angle A (degrees)	60	50	40	30	20	10
Angle B (degrees)	30	40	50	60	70	80
Sum (degrees)	90	90	90	90	90	90

From the above table, what did you find about the sum of the three angles in a right triangle?

Always  $180^\circ$



Let's explore the sum of three angles in a triangle.

### Total sum of angles in a triangle

#### 1 Angles of Triangles

A straight angle is  $180^\circ$ , isn't it?



2 Look at the sum of the 3 angles of a triangle in various ways.

1 Draw a triangle and measure the angles with a protractor.

The sum of the 3 angles is  $180^\circ$ .



2 Cut out the 3 angles and place them together as shown below.

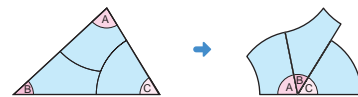

Since the 3 angles together make a straight line, the sum of these angles is  $180^\circ$ .

3 Put together triangles with the same shape and size to make a continuous pattern without any gaps.

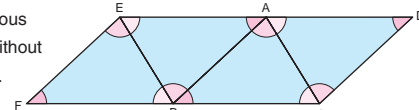

Since 3 angles at points A and B make a straight line, their sums are  $180^\circ$ .

4 Fold a triangle to connect the 3 angles.

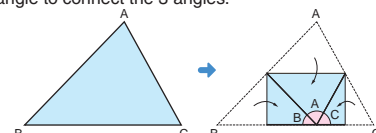

Since the 3 angles make a straight line, the sum is  $180^\circ$ .

## Lesson Flow

### 1 Review the previous lesson.

#### 2 1 Explore the 2 angles of a right triangle that are not $90^\circ$ .

- T** Introduce the Main Task. (Refer to the BP)
- T** Ask the students' to use a protractor to measure the angles in a triangle.
- S** Use a protractor to measure the angles of the 2 different set squares (triangle rulers) excluding the right angle.
- T** What is the sum of the 2 angles that are not right angles?
- S** Give Answers as (A)  $45 + 45 = 90^\circ$  and (B)  $30 + 60 = 90^\circ$ .

#### 3 1 1 to 4 Measure the angles of various triangles formed and analyse the results.

- T** What will change when we move vertex B towards vertex C in triangle (C)?
- S** 1 Angle B will increase in size.
- S** 2 Angle A will decrease in size.
- S** 3 As vertex B increases, angle A decreases in size.

**TN** Students should notice that the angle of vertex B will increase in size while the angle of vertex A will reduce in size.

**S** 4 Complete the table and confirm the changes in the angle sum for vertex B and A.

**T** What did we find from the results on the table?

**S** Confirm that the sum of the 2 angles will always be  $90^\circ$ .

#### 4 Discuss about the interior angle sum of triangles using the results from 1.

**T/S** Discuss from the findings, the angle sum of a triangle.

**S** Explain that the sum of the 2 angles ( $90^\circ$ ) plus the right angle ( $90^\circ$ ) will be  $180^\circ$ .

#### 5 2 Discuss the four methods 1 to 4 to determine that the angle sum of a triangle is $180^\circ$ .

**S** Explain each method.

(1) Measure the 3 angles with a protractor to get the angle sum  $180^\circ$ .

(2) Cut out and place the 3 angles to give a straight angle which is  $180^\circ$

(3) Put together the vertex of congruent triangles. The 3 angles FEB will come together forming a straight angle to give the sum of  $180^\circ$ .

(4) Fold the triangle to connect the 3 angles to form a straight angle with a sum of  $180^\circ$ .

#### 6 Important Point

**T/S** Explain the important point in the box  .

#### 7 Summary

**T** What have you learned in this lesson?

**S** Present ideas on what they have learned.

**T** Use students' ideas to confirm the important concepts of this lesson.

 In any triangles, the sum of the three angles is  $180^\circ$ .

**3** Let's calculate and fill in the  with appropriate numbers.

**1**

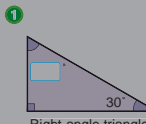

Right-angle triangle

**2**



Isosceles triangle

The sum of the three angles is  $180^\circ$ ...



**3**

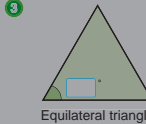

Equilateral triangle

**4**

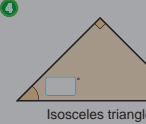

Isosceles triangle

**5**

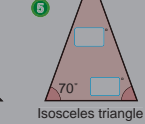

Isosceles triangle

**4** Look at the triangle below.

**1** Find the sum of angles (a) and (b).

**2** What is angle (c)?

**3** What can you conclude about the relationship among angles (a), (b) and (c)?

Since,  $a + b + 55^\circ = 180^\circ$ , ...

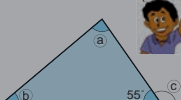

**5** Let's calculate and fill in the  with appropriate numbers.

**1**

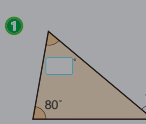

**2**

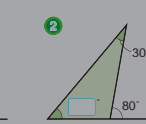

**3**

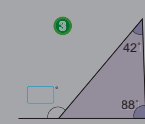

50 =  ×

### Sample Blackboard Plan

Lesson 031 Sample Blackboard Plan is on page 61.

### Lesson Objective

- To calculate angles using the sum of 3 angles ( $180^\circ$ ) in a triangle.

### Prior Knowledge

- Quadrilaterals and triangles
- Perpendicular lines, parallel lines and quadrilaterals
- Angles (Grade 4)

### Preparation

- Triangles of all the tasks

### Assessment

- Find the unknown angles using the angle sum of  $180^\circ$  and other properties. **F**
- Demonstrate that the sum of two interior angles opposite an exterior angle in a triangle are equal. **F**

### Teacher's Notes

Relationship of interior and exterior angles of a triangle.

The sum of the two angles (a) and (b) which are opposite to angle (c) are equal in size to that of the exterior angle (d).

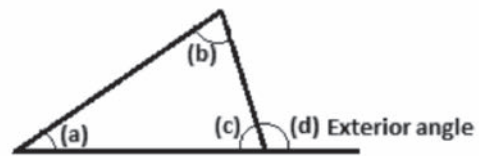

- $(a) + (b) + (c) = 180^\circ$
- $(c) + (d) = 180^\circ$
- $(a) + (b) = (d)$



In any triangles, the sum of the three angles is  $180^\circ$ .

### Calculating angles in a triangle

3 Let's calculate and fill in the  with appropriate numbers.

1

Right-angle triangle

2

Isosceles triangle

3

Equilateral triangle

4

Isosceles triangle

5

Isosceles triangle

The sum of the three angles is  $180^\circ$ ...

### Interior and exterior angles in a triangle.

4 Look at the triangle below.

1 Find the sum of angles (a) and (b).  $40^\circ + 85^\circ = 125^\circ$

2 What is angle (c)?  $85^\circ + 40^\circ = 125^\circ$

3 What can you conclude about the relationship among angles (a), (b) and (c)? **Sum of angle 'a' and 'b' is equal to angle 'c'.**

Since,  $a + b + 55^\circ = 180^\circ$ , ...

5 Let's calculate and fill in the  with appropriate numbers.

1

2

3



## Lesson Flow

### 1 Review the previous lesson.

### 2 3 Calculate unknown angles of a triangle.

- T Introduce the Main Task. (Refer to the BP)
- T Allow the students to discuss and demonstrate how they can calculate and find the unknown angles in a triangle.
- S Explain by demonstrating the use of the angle sum of  $180^\circ$  to calculate 1.
- S Complete activity 2 to 5 to find angles using the angle sum of  $180^\circ$  and other properties of triangles.
- T Confirm students' answers.

### 3 4 Investigate the relationship of interior and exterior angles of a triangle.

- S 1 Calculate the sum of angle (a) and (b) since  $(a) + (b) + 55 = 180^\circ$ .  
Sum of angle (a) and (b) is  $180^\circ - 55^\circ = 125^\circ$

- S 2 Calculate angle (c) as  $125^\circ$  since  $55^\circ + 125^\circ = 180^\circ$  on a straight line.
- S 3 Conclude that angle (c) has the same angle size as the sum of angle (a) and (b).
- T Confirm students' answers.
- TN The sum of two interior angles (a) and (b) is equal to the exterior angle (c).

### 4 5 Calculate the interior and exterior angles of triangles 1 to 3.

- T Ask the students to complete the task using what they have learned.
- S Calculate to find the unknown angles in 1 to 3.
- T Confirm students' answers.

### 5 Summary

- T What have you learned in this lesson?
- S Present ideas on what they have learned.
- T Use students' ideas to confirm the important concepts of this lesson.

## Sample Blackboard Plan

**Date:**  
**Unit:** Congruence and Angles of Figures  
**Sub-unit:** 2. Angles of Triangles and Quadrilaterals

**Review**

3 Let's calculate and fill the  with appropriate numbers.

**MT: Let's calculate the angles in triangles.**

1

Right angle triangle

2

Isosceles triangle

3

Equilateral triangle

4

Isosceles triangle

5

Isosceles triangle

4 Look at the triangle below.

1 Find the sum of angles a and b.  
 $85^\circ + 40^\circ = 125^\circ$

2 What is angle c?  
 $125^\circ$

3 What can you conclude about the relationships amongst angles a, b and c?  
The sum of angle a and b is equal to angle c.

5 Let's calculate and fill in the  with appropriate numbers.

1

+  $80^\circ = 140^\circ$   
 $140^\circ - 80^\circ = 60^\circ$

2

$30^\circ + \text{} = 80^\circ$   
 $80^\circ - 30^\circ = 50^\circ$

3

$42^\circ + 88^\circ = 130^\circ$

**Summary**  
The angle sum can be calculated using the interior and exterior angles of the triangles.

### Lesson Objective

- To understand the sum of interior angles of a quadrilateral is  $360^\circ$ .

### Prior Knowledge

- Quadrilaterals and triangles
- Angle sum of Triangles
- Angles (Grade 4)

### Preparation

- Protractor and ruler

### Assessment

- Investigate the angle sum of various quadrilaterals.
- F** Explain various ways to show that the angle sum of quadrilaterals are  $360^\circ$ . **S**

### Teacher's Notes

The Angle sum of Quadrilaterals.

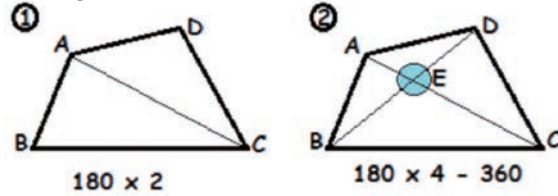

① Divide a quadrilateral into 2 triangles along a diagonal and based on the fact that the sum of 3 angles of a triangle is  $180^\circ$ . When we multiply  $180^\circ$  by 2, we get  $360^\circ$ .

② Add point E to the inside of the quadrilateral, then divide the quadrilateral into 4 triangles by connecting point E with each of the vertex.

Get the sum of all angles by multiplying  $180^\circ$  by 4 and subtract  $360^\circ$  which is the sum of the angles around point E.

#### Angles of Quadrilaterals

Finding total sum of angles in a quadrilateral.

- 6 Let's explore the sum of four angles in a quadrilateral in various ways.

How did we find the sum of three angles in the triangles?

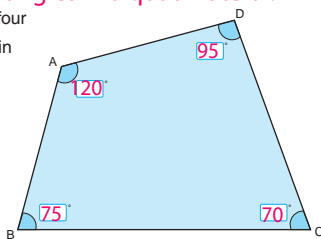

- Measure the four angles with a protractor.
- Let's calculate through dividing the quadrilateral by diagonals.



Vavi's Idea

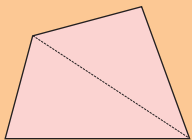

Divide by a diagonal. There are two triangles inscribed. Therefore,  
 $180^\circ \times 2 = 360^\circ$ .



Mero's Idea

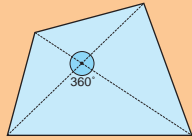

Divide a quadrilateral into four by diagonals. There are four triangles inscribed,  $180^\circ \times 4 = 720^\circ$  subtract the extra  $360^\circ$ , so  $360^\circ$ .

- 3 Let's think about and discuss other ways of finding the sum of angles in a quadrilateral.

□ - □ = 51

52 = □ × □

- 4 Let's explore the sum of quadrilaterals through tessellation.

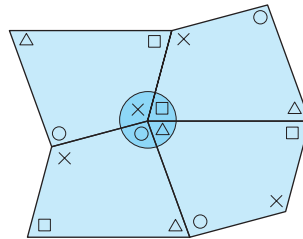

Let's tessellate to find the sum of angles using the four congruent quadrilaterals.



- 5 Share your findings with your friends.

What have you learned?



In any quadrilateral, the sum of 4 angles is  $360^\circ$ .

- 7 Let's fill in the □ by calculations.

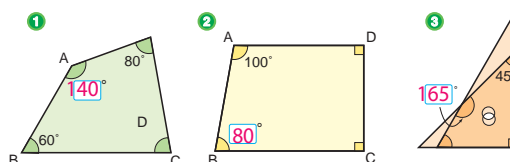

## Lesson Flow

### 1 Review the previous lesson.

### 2 6 Investigate the sum of 4 angles in a quadrilateral.

**T** Introduce the Main Task. (Refer to the BP)

**S** ① Use a protractor to measure the 4 angles of the quadrilateral.

**T** What is the sum of the 4 angles?

**S** Calculate the angle sum to  $360^\circ$ .  
 $120^\circ + 75^\circ + 70^\circ + 95^\circ = 360^\circ$

### 3 2 Calculate by dividing the quadrilateral using diagonal lines.

**T** Remind the students that when the quadrilaterals are divided by diagonal lines, triangles are formed. Allow the students to use this idea to calculate Vavi's and Mero's ideas.

**S** Vavi's Idea:

Divide the quadrilateral with 1 diagonal line to make 2 triangles inscribed, therefore

$$180^\circ \times 2 = 360^\circ.$$

Mero's Idea:

Divide the quadrilateral with 2 diagonals to make 4 triangles inscribed, therefore

$$180^\circ \times 4 = 720^\circ - 360^\circ \text{ to get } 360^\circ.$$

**T** Confirm students' answers.

### 4 Discuss other ways for finding the angle sum of quadrilaterals.

**T** ③ Allow students to find other ways using Vavi's and Mero's ideas.

**S** Draw 2 diagonals to form 3 triangles and calculate  $180^\circ \times 3 = 540^\circ - 180^\circ$  to get  $360^\circ$ .

**S** ④ Explore the sum through tessellating congruent quadrilaterals.

**S** ⑤ Share ideas with friends about what was found when tessellating.

**TN** Students should use the same idea of tessellation by manipulating the four congruent quadrilaterals to investigate the angle sum of quadrilaterals.

In this case, where the 4 angles meet at one point in the centre, they form a  $360^\circ$  angle.

### 5 Important Point

**T/S** Explain the important point in the box  .

### 6 7 Complete the activity by calculating the unknown angles.

**S** Calculate the unknown angles for the quadrilaterals ① to ③.

**T** Confirm students' calculations.

### 7 Summary

**T** What have you learned in this lesson?

**S** Present ideas on what they have learned.

**T** Use students' ideas to confirm the important concepts of this lesson.

## Sample Blackboard Plan

**Date:**  
**Unit:** Congruence and Angles of Figures  
**Sub-unit:** 2. Angles of Triangles and Quadrilaterals

**Review**

**MT:** Let's investigate the Angle sum of Quadrilaterals.

⑥ Let's explore the sum of four quadrilaterals in various ways.

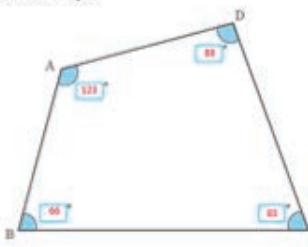

① Measure the four angles with a protractor.

$123^\circ + 66^\circ + 83^\circ + 88^\circ = 360^\circ$

② Let's calculate through dividing the quadrilateral by a diagonal.

Vavi's Idea



Divide by a diagonal. There are two triangles inscribed. Therefore,  $180^\circ \times 2 = 360^\circ$ .

Mero's Idea

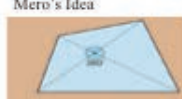

Divide a quadrilateral into four by diagonals. There are four triangles inscribed.  $180^\circ \times 4 = 720^\circ$ . subtract the extra  $360^\circ$ , we  $360^\circ$ .

③ Let's think about other ways of finding and discuss.



$(180^\circ \times 3) - 180^\circ = 360^\circ$ .

④ Let's explore the sum through tessellation.



⑤ What have you learnt?  
 Where the 4 angles meet at one point in the center, they form a  $360^\circ$  angle.

**In any quadrilateral, the sum of 4 angles is  $360^\circ$ .**

⑦ Let's fill in the  by calculations.



$360^\circ - (60^\circ + 80^\circ + 80^\circ) = 140^\circ$



$360^\circ - (90^\circ + 90^\circ + 100^\circ) = 80^\circ$



$360^\circ - (60^\circ + 90^\circ + 45^\circ) = 165^\circ$

**Summary**  
 In any quadrilateral, the sum of 4 angles is  $360^\circ$ .

### Lesson Objective

- To think about how to find the sum of interior angles of polygons.

### Prior Knowledge

- Quadrilaterals and triangles
- Angle sum of Triangles
- Angles (Grade 4)

### Preparation

- Protractor and ruler

### Assessment

- Think about how to find the angle sum of polygons. **F**
- Calculate how to find angle sum of polygons. **S**

### Teacher's Notes

The angle sum of polygons can be calculated when triangles are inscribed within a polygon. Divide the polygon into triangles by connecting each of the vertex at a point to form  $360^\circ$ . Get the sum of all angles by multiplying  $180^\circ$  by the number of triangles and subtract  $360^\circ$  which is the sum of the angles around the point.

The same idea will be expanded in Gr.6 using pronumerals.

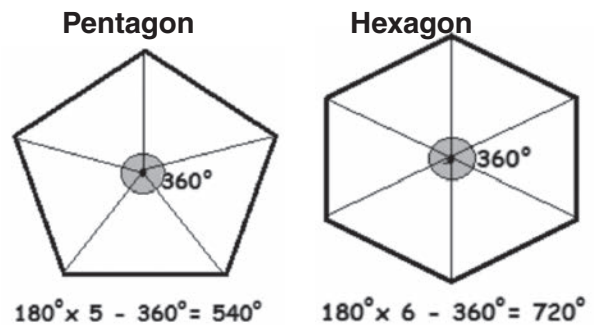

### Angles of Polygons

A pentagon is a five sided figure.

- 8** Let's explore how to find the sum of 5 angles in a pentagon.

- 1** Can you tessellate?



For tessellation of figures, the sum of angles which meet at one vertex is  $360^\circ$ . In the case of a pentagon, it cannot be tessellated.

- 2** Let's divide a pentagon into triangles.



**Yamo's Idea**

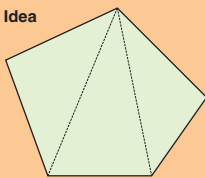

If I draw diagonals from a vertex...

Draw diagonals and divide it into **3** triangles.  
Therefore,  $180^\circ \times \mathbf{3} = \mathbf{540}^\circ$ .



**Mero's Idea**

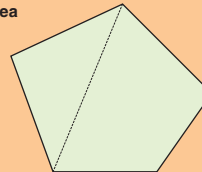

If I draw a diagonal...

Divide a pentagon into a triangle and a quadrilateral.  
Therefore,  $180^\circ + \mathbf{360}^\circ = \mathbf{540}^\circ$ .

- 3** Let's think about other ways of finding the sum of angles and discuss.



In any pentagon, the sum of 5 angles is  $540^\circ$ .

- 9** A hexagon is a six sided figure.

Let's explore how to find the sum of 6 angles in a hexagon.

- $360^\circ + 360^\circ = 720^\circ$  (by using one diagonal in making two quadrilaterals)
- $180^\circ \times 4 = 720^\circ$  (by making 3 diagonals in producing 4 triangles).

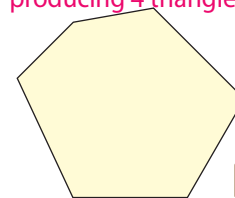

Write down how you find the sum.



In any hexagon, the sum of 6 angles is  $720^\circ$ .

## Lesson Flow

**1** Review the previous lesson.

**2** Investigate how to find the sum of angles in a pentagon.

**T** Introduce the Main Task. (Refer to the BP)

**T** **8** Allow the students to discuss how to find the sum of 5 angles of a pentagon and ask them if they are able to tessellate pentagons like quadrilaterals.

**S** **1** Discover that pentagons cannot be tessellated.

**T** Confirm with students that pentagons cannot be tessellated. For tessellation of figures, the sum of angles which t one vertex is  $360^\circ$ .

**3** Important Point

**T/S** Explain the important point in the box  .

**4** Compare the 2 ideas of how to find the angle sum of pentagons.

**T** **2** Remind the students to use the angle sum of triangles and quadrilaterals to calculate.

**S** Yamo's Idea:

Divide the pentagon with 2 diagonal lines to make 3 triangles and calculate,

$$180^\circ \times 3 = 540^\circ.$$

Mero's idea:

Divide the pentagon into a triangle and quadrilateral and calculate the sum,

$$180^\circ + 360^\circ = 540^\circ.$$

**5** Discuss other ways of finding the angle sum of quadrilaterals.

**T** What are other ways to calculate the angle sum of the pentagon?

**S** **3** Draw 5 triangles inscribed in the pentagon with vertices joining in the centre to form an angle sum of  $360^\circ$  and calculate. (refer to angle sum of quadrilaterals)  $180^\circ \times 5 - 360^\circ = 540^\circ$ .

**6** Important Point

**T/S** Explain the important point in the box  .

**7** Discuss how to find the sum of 6 angles in a hexagon.

**T** **9** Give hints to the students to use the same ideas of how to find the angle sum of pentagons.

**S** Idea 1: Divide the hexagon with 3 diagonal lines to make 4 triangles and calculate,

$$180^\circ \times 4 = 720^\circ.$$

Divide the hexagon into a triangle and pentagon and calculate the sum,

$$180^\circ + 540^\circ = 720^\circ.$$

Idea 2: Draw 6 triangles inscribed in the pentagon with vertices joining in the centre to form an angle of  $360^\circ$  and calculate. (refer to angle sum of quadrilaterals)

$$180^\circ \times 6 - 360^\circ = 720^\circ.$$

**8** Important Point

**T/S** Explain the important point in the box   and  .

**9** Summary

**T** What have you learned in this lesson?

**S** Present ideas on what they have learned.

**T** Use students' ideas to confirm the important concepts of this lesson.



A shape which is enclosed by straight lines, such as a triangle, quadrilateral, pentagon, hexagon, etc., is called a polygon. In a **polygon**, each straight line that connects any two vertices other than adjacent sides is called a **diagonal**.

**10** Summarise the relationships for the sum of angles in polygons by filling in the table below.

	Triangle	Quadrilateral	Pentagon	Hexagon	Heptagon	Octagon	Nonagon
The number of triangles made by the diagonals from one vertex in a polygon		2	3	4			
The sum of angles	$180^\circ$	$360^\circ$	$540^\circ$	$720^\circ$			

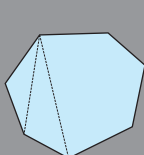

Heptagon

$$180^\circ \times \square = \square^\circ$$

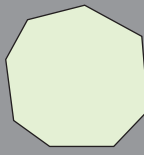

Octagon

$$180^\circ \times \square = \square^\circ$$

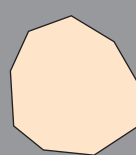

Nonagon

$$180^\circ \times \square = \square^\circ$$

### The Opposite Angles of a Parallelogram

**11** Let's use what you have learned to explain that the opposite angles of a parallelogram are equal.



Let's draw diagonals.

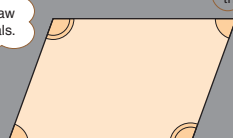

I've found a pair of congruent triangles.



## Sample Blackboard Plan

Lesson 034 Sample Blackboard Plan is on page 71.

# Unit 4

## Unit: Congruence and Angles of Figures Sub-unit 2: Angles of Triangles and Quadrilaterals Lesson 5 of 5

Textbook Page :  
055  
Actual Lesson 035

### Lesson Objectives

- To find the relationship of the sum of angles in polygons.
- To think about the characteristics of a parallelogram.

### Prior Knowledge

- Quadrilaterals and triangles
- Angle sum of Triangles
- Angles (Grade 4)

### Preparation

- Table in task 10 and the polygons
- Parallelogram in task 11

### Assessment

- Calculate the angle sum of other polygons using the number of triangles formed. **F**
- Describe the angle properties of a parallelogram based on congruence. **S F**

### Teacher's Notes

Students will realise that the number of triangles will increase in polygons according to the number of sides and therefore the sum of angles increases as well.



A shape which is enclosed by straight lines, such as a triangle, quadrilateral, pentagon, hexagon, etc., is called a polygon. In a **polygon**, each straight line that connects any two vertices other than adjacent sides is called a **diagonal**.

- 10 Summarise the relationships for the sum of angles in polygons by filling in the table below.

	Triangle	Quadrilateral	Pentagon	Hexagon	Heptagon	Octagon	Nonagon
The number of triangles made by the diagonals from one vertex in a polygon		2	3	4	5	6	7
The sum of angles	180°	360°	540°	720°	900°	1080°	1260°

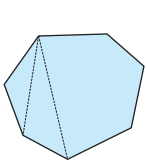

Heptagon

$$180^\circ \times 5 = 900^\circ$$

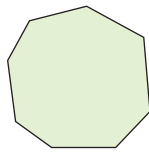

Octagon

$$180^\circ \times 6 = 1080^\circ$$

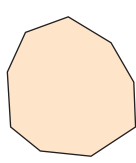

Nonagon

$$180^\circ \times 7 = 1260^\circ$$

### The Opposite Angles of a Parallelogram



- 11 Let's use what you have learned to explain that the opposite angles of a parallelogram are equal.



Let's draw diagonals.

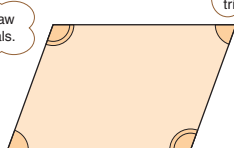

I've found a pair of congruent triangles.



□ - □ = 55

### Lesson Flow

#### 1 Review the previous lesson.

- T Introduce the Main Task. (Refer to the BP)
- T Briefly review the previous lesson concepts on the angle sum of Pentagons and Hexagons.

How many triangles were formed from one vertex in a pentagon and a hexagon?

- S Pentagon-3 triangles, Hexagon- 4 triangles

#### 2 Find the relationship of the sum of angles in polygons.

- T 10 Ask students to explain how they calculated the angles using this information.
- S Explain that the number of triangles times 180° equals the sum of angles.
- T Ask the students to complete the table in the textbook.
- S Complete the table by identifying the number of triangles before calculating the angle sum for Heptagon, Octagon and Nonagon.

## Lesson Flow

### 3 Discuss the properties of opposite angles in a parallelogram.

- T 11 Ask students to discuss and explain why opposite angles in a parallelogram are equal.
- S When a diagonal line is drawn to make two congruent triangles, the corresponding opposite angles are equal.
- TN Students should base their explanation on the fact that when a diagonal is drawn to make triangles, the 2 triangles are congruent. According to what they have learned previously, corresponding angles in congruent figures are equal.

### 4 Summary

- T What have you learned in this lesson?
- S Present ideas on what they have learned.
- T Use students' ideas to confirm the important concepts of this lesson.

## Sample Blackboard Plan

**Date:**  
**Unit:** Congruence and Angles of Figures  
**Sub-unit:** 2. Angles of Triangles and Quadrilaterals

**Review**  
MT: Let's calculate the interior sum of a Pentagon and Hexagon.

6 Let's explore how to find the sum of five angles in a pentagon.

2 Let's divide a pentagon into triangles.

Yamo's Idea



$180^\circ \times 3 = 540^\circ$

Mero's Idea



$180^\circ + 360^\circ = 540^\circ$

3 Let's think about other ways of finding and discuss.



$(180^\circ \times 5) - 360^\circ = 540^\circ$

In any pentagon, the sum of 5 angles is  $540^\circ$ .

9 Let's explore how to find the sum of six angles in a hexagon.

1 Can you tessellate?

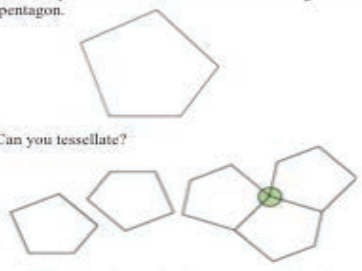

Pentagons cannot be tessellated. For tessellation of figures the sum of angles which meet at one vertex is  $360^\circ$ .

In case of a pentagon, it cannot be tessellated. For tessellation of figures, the sum of angles which meet at one vertex is  $360^\circ$ .



$180^\circ \times 4 = 720^\circ$



$180^\circ + 540^\circ = 720^\circ$

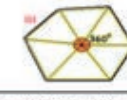

$(180^\circ \times 6) - 360^\circ = 720^\circ$

In any pentagon, the sum of 6 angles is  $720^\circ$ .

A shape which is surrounded by straight lines, such as Triangle, Quadrilateral, Pentagon, Hexagon, etc., is called a polygon. In a polygon, each straight line that connects any two vertices other than adjacent sides is called a diagonal.

**Summary**  
We can find angle sum of polygons by ;

- dividing the polygon into triangles and multiplying the number of triangles by  $180^\circ$ .
- subtracting  $360^\circ$  from  $(180^\circ \times \text{the number of triangles})$  inscribed in the polygon.

P. 71

## Sample Blackboard Plan

**Date:**  
**Unit:** Congruence and Angles of Figures  
**Sub-unit:** 2. Angles of Triangles and Quadrilaterals

**Review**  
MT: Let's think about the relationship of the sum of angles in polygons.

10 Summarises the relationship for the sum of angles in polygons by filling in the table.

	Triangle	Quadrilateral	Pentagon	Hexagon	Heptagon	Octagon	Nonagon
The number of triangles made by the diagonals from one vertex in the polygon		2	3	4	5	6	7
The sum of angles	$180^\circ$	$360^\circ$	$540^\circ$	$720^\circ$	$900^\circ$	$1080^\circ$	$1260^\circ$



Heptagon  
 $180^\circ \times 5 = 900^\circ$





Octagon  
 $180^\circ \times 6 = 1080^\circ$



Nonagon  
 $180^\circ \times 7 = 1260^\circ$

### The Opposite Angles of a Parallelogram

11 Let's explain that the opposite angles of a parallelogram are equal.

Corresponding angles in congruent figures are equal.

A = C  
C = A therefore B = D

When a diagonal is drawn, we have two congruent triangles.

Corresponding angles in congruent figures are equal.

**Summary**  
As the number of triangles increases by polygon, the angle sum increases by  $180^\circ$ .  
Corresponding angles in congruent figures are equal.

P. 71

# Unit 4

## Unit: Congruence and Angles of Figures Exercise, Problems and Evaluation Lesson 1 and 2 of 2

Textbook Page :  
056 and 057  
Actual Lesson 036 and 037

### Lesson Objective

- To confirm their understanding on the concepts they learned in this unit by completing the Exercise, Problems and the Evaluation Test confidently.

### Prior Knowledge

- All the contents covered in this unit

### Preparation

- Evaluation test copy for each student

### Assessment

- Complete the Exercise and Problems correctly. **S**

### Teacher's Notes

This is the last lesson of Chapter 4.

Students should be encouraged to use the necessary skills learned in this unit to complete all the Exercises and solve the Problems in preparation for the evaluation test. The test can be conducted as assesment for your class after completing all the exercises. Use the attached evaluation test to conduct assesment for your class after finishing all the exercises and problems as a seperate lesson.

### EXERCISE

1 Let's calculate and fill in the  with numbers. Pages 49 to 54

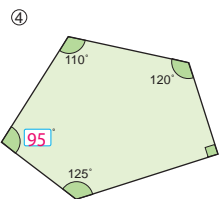
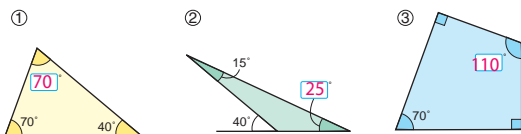

5 A hexagon is developed by 6 equilateral triangles.

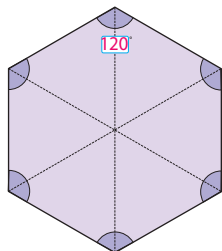

Let's calculate.

- |                          |                          |                           |
|--------------------------|--------------------------|---------------------------|
| ① $24 \div 2$ <b>12</b>  | ② $69 \div 3$ <b>23</b>  | ③ $96 \div 4$ <b>24</b>   |
| ④ $44 \div 11$ <b>4</b>  | ⑤ $72 \div 12$ <b>6</b>  | ⑥ $92 \div 23$ <b>4</b>   |
| ⑦ $168 \div 3$ <b>56</b> | ⑧ $675 \div 9$ <b>75</b> | ⑨ $464 \div 8$ <b>58</b>  |
| ⑩ $288 \div 48$ <b>6</b> | ⑪ $333 \div 37$ <b>9</b> | ⑫ $969 \div 17$ <b>57</b> |

$56 = \square \times \square$

### PROBLEMS

1 Let's draw a congruent quadrilateral to the one below.

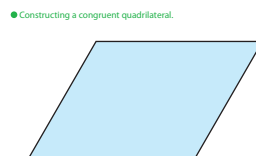

2 Let's fill in the  with numbers.

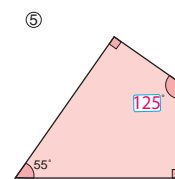
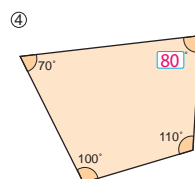
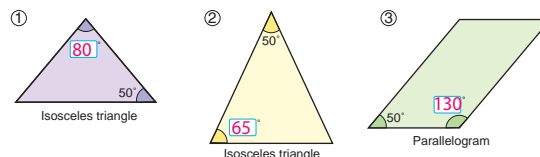

$\square - \square = 57$



## Lesson Flow

### 1 Complete the Exercise

- S Solve all the exercises.
- T Confirm students' answers.
- TN ① Calculate by filling in the box .

### 2 Solve the Problems

- S Solve all the problems.
- T Confirm students' answers.
- TN ① Constructing a congruent triangle.
- ② Using the sum of angles in a polygon.

### 3 Complete the Evaluation Test

- TN Use the attached evaluation test to conduct assesment for your class after finishing all the exercises and problems as a seperate lesson.
- S Complete the Evaluation Test.

**End of Chapter Test:**

Chapter 4: Congruence and Angles of Figures	Name: _____	Score _____ / 100
--	-------------	-------------------

**Date:** \_\_\_\_\_

[20 marks for the set of right answers]

1. Find all congruent triangles with A.

Answer: C and D

2. The 2 quadrilaterals shown below are congruent. Answer the following questions.  
[4 x 20 marks = 80 marks]

- (1) Which vertex corresponds to Vertex D?    Answer: Vertex E
- (2) Which side corresponds to Side BC?    Answer: Side GH
- (3) Which angle corresponds to Angle G?    Answer: Angle B
- (4) Which diagonal corresponds to Diagonal BD? Answer: Diagonal GE

**End of Chapter Test**

**Date:**

Chapter 4: Congruence and Angles of Figures	Name:	Score / 100
--	-------	----------------

1. Find all the congruent triangles with A.

[20 marks for the set of right answers]

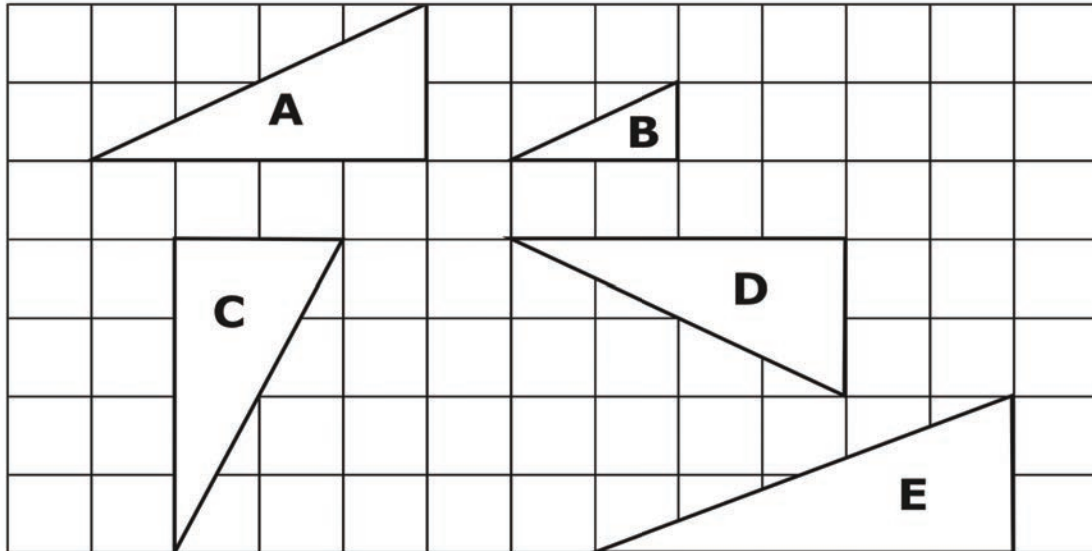

Answer:

2. The two quadrilaterals shown below are congruent. Answer the following questions.

[4 × 20 marks = 80 marks]

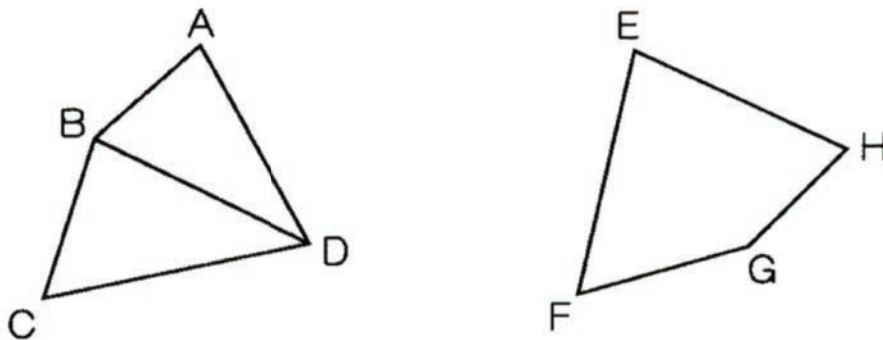

① Which vertex corresponds to Vertex D?

Answer:

② Which side corresponds to Side BC?

Answer:

③ Which angle corresponds to Angle G?

Answer:

④ Which diagonal corresponds to Diagonal BD?

Answer:

# Chapter 5 Division of Decimal Numbers

## 1. Content Standard

5.1.5 Apply the process of division to divide a decimal number by decimal number and a whole number by a decimal number.

## 2. Unit Objectives

- To understand the meaning of division of decimal numbers and use it correctly.
- To understand the meaning of division when the divisor is a decimal number.
- To think about how to calculate division of decimal numbers and be able to calculate it.

## 3. Teaching Overview

Students already learned division of decimal number divided by whole number. In this unit, they will learn division of dividing by decimal numbers.

### Operation of Whole Numbers and Decimal Numbers ÷ Decimal Numbers :

They learn that they can calculate them by thinking the same way as divisions dividing by whole numbers. They will notice that they can find the answers by moving decimal points which means applying rules of divisions learned before.

They should also pay attention to the relationship between the quotient and the divisor.

If quotient is smaller than 1, the quotient will be bigger than the dividend.

### Division Problems :

In this topic, students learn how to estimate result of calculation, meaning of remainder, the reason for rounding the quotient, etc.

### What Kind of Calculation Would It Be? :

Students learn how to decide the appropriate mathematical expression.

Activities making mathematical stories will develop the skill of making decision on expressions.

## 4. Related Learning Contents

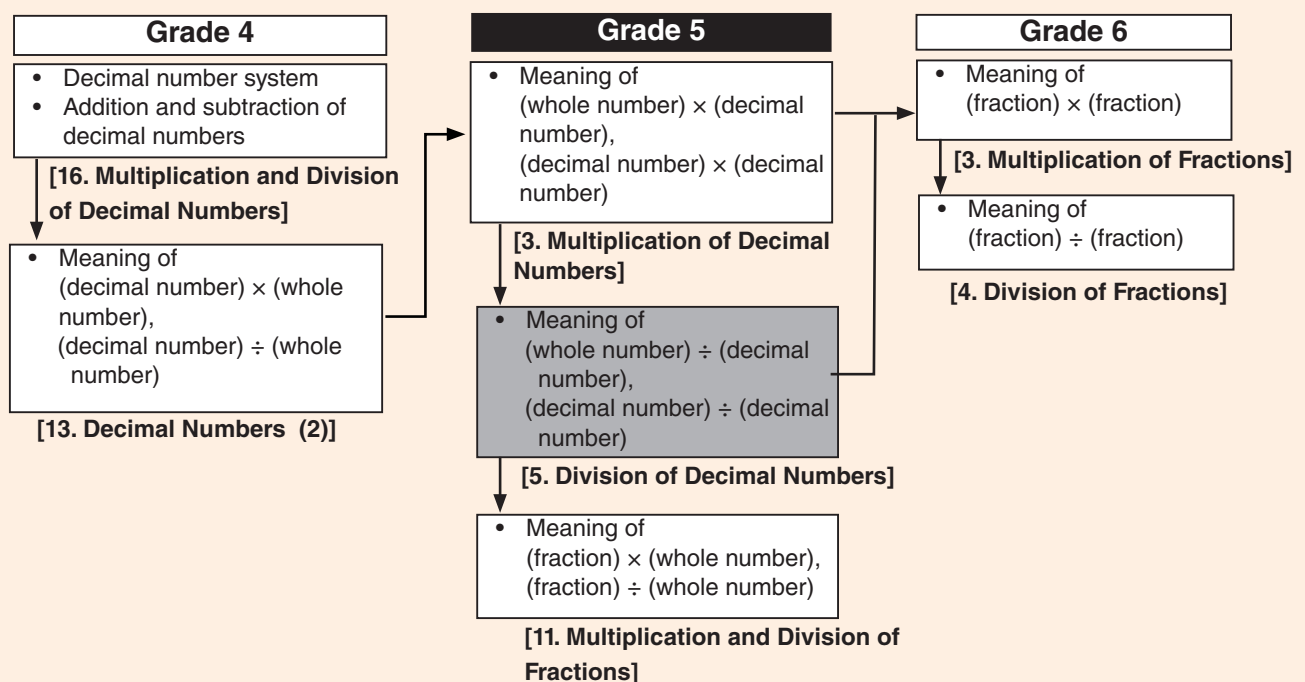

# Unit 5

## Unit: Division of Decimal Numbers

### Sub-unit 1: Operation of Whole Numbers ÷ Decimal Numbers

#### Lesson 1 of 2

Textbook Page :  
058 to 060  
Actual Lesson 038

### Sub-unit Objectives

- To understand the meaning of whole number ÷ decimal number and make a mathematical expression.
- To think about how to calculate whole number ÷ decimal number.
- To think about how to calculate whole number ÷ decimal number in vertical form.

### Lesson Objectives

- To understand the meaning of whole number ÷ decimal number and make a mathematical expression.
- To think about how to calculate whole number ÷ decimal number.

### Prior Knowledge

- Rules of Division
- Multiplication of Decimal Number
- Calculating Whole Numbers × Decimal Numbers
- Calculating Decimal Number × Decimal Number
- Rules for Calculation

### Assessment

- Divide a whole number by a decimal number if the divisor is a decimal number. **F**
- Demonstrate the understanding of the meaning of whole number ÷ decimal number. **S**

### Preparation

- Tape diagram of **1** and Mero's and Kekeni's idea on chart

### Teacher's Notes

- Ideas of two students here are to find out which one is cheaper by knowing the cost of 1L according to the situation.
- Remind students that both Mero and Kekeni are trying to find the answer of  $56 \div 1.6$ .
- Mero's thinking is based on the cost of 0.1 L, which makes the division of a whole number possible.
- Kekeni used the idea on the rule of division and then calculated by making the divisor into a whole number.

5

## Division of Decimal Numbers

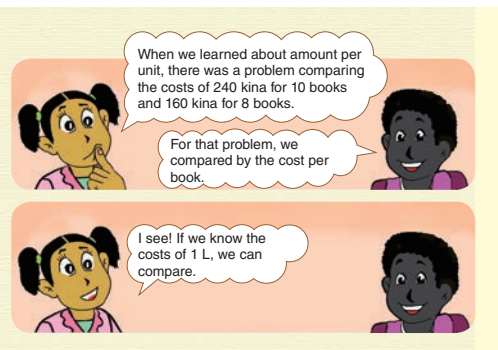

### 1 Operation of Whole Numbers ÷ Decimal Numbers

1 Jane and Betu went to the supermarket to buy juice.

1 How much is the cost of 1 L in the 2 L container?

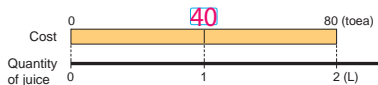

A Write a mathematical expression.

$$80 \div 2$$

Cost (Kina)	?	80
Quantity of juice (L)	1	2

B Let's calculate the mathematical expression in A

2 How much is the cost of 1 L for the 1.6 L container?

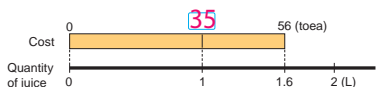

$$58 = \square \times \square$$

A Write a mathematical expression.

$$56 \div 1.6$$

Cost (toea)	?	56
Quantity of juice (L)	1	1.6

B Approximately how much would the cost be?

$$\text{Around } 56 \div 2 = 28 \text{ or } 60 \div 2 = 30$$



As shown with the quantity of juice, when the divisor is a decimal number instead of a whole number, the expression is the same as for division of whole numbers and means to calculate the quantity per unit.

C Let's think about how to calculate  $56 \div 1.6$



If we find out the cost of 0.1 L first, then we can find the cost of 1 L from that number.

Can we use the rules of division?



$$\square - \square = 59$$

## Lesson Flow

### 1 Think about how to find which juice container is cheaper.

- T** Ask the students to look at the pictures and have pre-discussion by posing questions.
- S** Do pre-discussions using the pictures.
- TN** Comparison may be difficult because the cost and the quantity are not the same.
- T** Introduce the Main Task. (Refer to the BP)
- T/S** **1** Read and understand the situation.
- S** Discuss and compare the situation about finding which juice container is cheaper.

### 2 Finding the cost of 1 L in the 2 L juice container.

- T** **1** How much is the cost of 1 L in the 2 L container?
- TN** Use the tape diagram and the table of information to write the mathematical expression.
- T** **A** Write a mathematical expression.
- S** Expression:  $80 \div 2$ .
- T** **B** Confirm with students that they can find the answer by calculating  $80 \div 2$ .
- S**  $80 \div 2 = 40$ . So the cost for 1 L of juice is 40 toea.

### 3 Finding the cost of 1 L in the 1.6 L juice container.

- T** **2** How much is the cost of 1 L for the 1.6 L container?
- TN** Apply the similar method used in **1**.
- S** **A** Write a mathematical expression using the tape diagram and table of information. ( $56 \div 1.6$ )
- T** Approximately how much will the cost be?
- S** **B** By estimation  $60 \div 2 = 30$ , so around 30 toea.
- TN** Students can find out which is cheaper if they compare each juice container by 1 L.

### 4 Important Point

- T/S** Explain the important point in the box  .

### 5 Think about how to calculate $56 \div 1.6$

- T** **C** Ask students on how to calculate  $56 \div 1.6$  and present their ideas.
- S** Present and explain their ideas.

### 6 Explain Mero's and Kekeni's ideas on how to calculate $56 \div 1.6$

- S** Explain Mero's and Kekeni's ideas.
- TN** **D** Mero's Idea: His thinking is based on the cost of 0.1 L, which makes the division of a whole number possible.

Kekeni's Idea: She used the idea on the rule of division and then calculated by making the divisor into a whole number.

- T** **E** Which idea corresponds to the two tables below on page 60?
- S** Table 1 corresponds to Mero's idea and table 2 corresponds to Kekeni's idea.
- S** In both ideas, the decimal numbers are changed to whole number to make calculation easier.

### 7 Summary

- T** What have you learned in this lesson?
- S** Present ideas on what they have learned.
- T** Use students' ideas to confirm the important concepts of this lesson.

**D** Let's explain the ideas below.

**Mero's Idea**

Cost of 1.6 L is 56 toea.  
 1.6 L is 16 sets of 0.1 L so,  
 Cost of 0.1 L is  $56 \div 16 = 3.5$  (toea)  
 10 times of 0.1 L is the cost of 1 L, so  
 Cost of 1 L is  $3.5 \times 10 = 35$  (toea)

My idea uses the cost of 0.1 L to calculate.

**Kekeni's Idea**

If I use the rules of division...  
 If I buy juice 10 times of 1.6 L, the price will also become 10 times more. However, the cost per 1 L is the same.

Cost of 1 L when I buy 1.6 L of juice  $56 \div 1.6 = 35$  (toea)

Cost of 1 L when I buy 16 L of juice  $560 \div 16 = 35$  (toea)

**E** Which idea corresponds to each of the two tables shown below?  
 Discuss what the two ideas have in common.

**1**

Cost (toea)	3.5	35	56
Quantity (L)	0.1	1	1.6

$\times 10$     $\div 16$

**2**

Cost (toea)	35	56	560
Quantity (L)	1	1.6	16

$\div 16$     $\times 10$

60 = □ × □

## Sample Blackboard Plan

Lesson 038 Sample Blackboard Plan is on page 79.

# Unit 5

## Unit: Division of Decimal Numbers

### Sub-unit 1: Operation of Whole Numbers ÷ Decimal Numbers

#### Lesson 2 of 2

Textbook Page : 061  
Actual Lesson 039

### Lesson Objective

- To think about how to divide whole number ÷ decimal number in vertical form.

### Prior Knowledge

- How to calculate Whole Number ÷ Decimal Number (Previous lesson)
- The idea per unit
- The rules of division

### Preparation

- Chart on vertical calculation in (F)
- Chart for important point
- Diagram for task 2

### Assessment

- Think about how to calculate whole number ÷ decimal number in vertical form. **F**
- Explain how to calculate whole number ÷ decimal number in vertical form. **S**
- Solve the exercises correctly. **S**

### Teacher's Notes

#### Supplementary Exercise

- |                          |                          |
|--------------------------|--------------------------|
| 1.) $9 \div 1.5 = [6]$   | 2.) $8 \div 1.6 = [5]$   |
| 3.) $10 \div 2.5 = [4]$  | 4.) $30 \div 2.6 = [15]$ |
| 5.) $27 \div 1.8 = [15]$ | 6.) $72 \div 4.5 = [16]$ |
| 7.) $98 \div 2.8 = [35]$ | 8.) $42 \div 1.4 = [30]$ |

(F) Let's explain how to divide  $320 \div 1.6$  in vertical form.

$$\begin{array}{r} 1.6 \overline{) 320} \\ \times 10 \downarrow \quad \times 10 \downarrow \\ 16 \overline{) 3200} \end{array}$$

The rules of division can be applied to division of decimal numbers as well.



In division, the answer does not change if the dividend and divisor are multiplied by the same number. When we divide a number by a decimal number, we can calculate by changing the dividend and divisor into whole numbers by using the rule of division.

- 2** Whole number ÷ Decimal number  
A rectangular flowerbed has a width of 2.4 m and an area of 12 m<sup>2</sup>. How long is the length in metres?

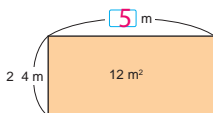

Approximately how many metres is it?



- 1** Let's write a mathematical expression.

$$12 \div 2.4$$

- 2** Let's think about how to calculate.  
**3** Let's think about how to divide in vertical form.

$$\begin{array}{r} 2.4 \overline{) 12} \\ \times 10 \downarrow \quad \times 10 \downarrow \\ 24 \overline{) 120} \\ - 120 \\ \hline 0 \end{array}$$

#### Exercise

Let's divide in vertical form.

- ①  $9 \div 1.8$     5    ②  $91 \div 2.6$     35    ③  $6 \div 4.8$     1.25

$$\square - \square = 61$$

### Lesson Flow

- 1** Review the previous lesson.
  - T** Introduce the Main Task. (Refer to the BP)
  - T** (F) Explain how to divide  $320 \div 1.6$  in vertical form.
  - TN** Divide the whole number by a decimal number. Change the divisor and the dividend into whole numbers. In this case, multiply the divisor and the dividend by 10.
  - S** Apply the rules of division to divide  $320 \div 1.6$
- 3** Important Point
  - T/S** Explain the important point in the box
- 4** Solve  $12 \div 2.4$  in vertical form by using the rules of division.
  - T/S** **2** Read and understand the situation.
  - T** **1** Explain the situation of this task and let students write the mathematical expression to get the answer for the .

## Lesson Flow

**S** Mathematical Expression:  $12 \div 2.4$

**T** **2** Let's think about how to calculate  $12 \div 2.4$

**S** Present their ideas with friends.

**5** Think about how to divide in vertical form.

**T** **3** Ask students to calculate in vertical form.

- S**
- Use the rule of division to change the decimal number into a whole number.
  - Multiply the divisor and the dividend with 10 to make the divisor become 24 and dividend become 120.
  - Then divide  $120 \div 24$  in vertical form.

**6** Complete the Exercise

**S** Solve the selected exercises.

**T** Confirm students' answers.

**7** Summary

**T** What have you learned in this lesson?

**S** Present ideas on what they have learned.

**T** Use students' ideas to confirm the important concepts of this lesson.

### Sample Blackboard Plan (Lesson 38)

**Date:**    **Unit:** Division of Decimal Numbers    **Topic 1:** Operation of Whole Numbers  $\div$  Decimal Numbers    **Lesson Number:** 1 of 2

**MT:** Let's think and investigate which juice is cheaper?

**MT:** Introduce the main task here.

[1] Jane and Betu went to the supermarket to buy juice.

**1** How much is the cost of 1L in the 2L container?

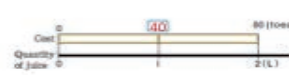

Cost (kina)	?	80
Quantity of juice(L)	1	2

A. Write a mathematical Expression.  $80 \div 2$

B. Let's calculate.  $80 \div 2 = 40$  Answer: 40 toea

**2** How much is the cost of 1 L for the 1.6 L container?

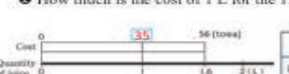

Cost (toea)	?	56
Quantity of Juice(L)	1	1.6

A. Write a mathematical Expression.  $56 \div 1.6$

B. Approximately how much the cost be?  
 Around:  $56 \div 2 = 28$  Answer: 28 toea or  
 Around:  $60 \div 2 = 30$  Answer: 30 toea.

Children's Ideas

D. Let's explain the ideas.  
 Explain Mero's and Kekeni's Ideas in the text book.

E. Which ideas corresponds to each of the two tables. Discuss what the two tables have in common.

Cost (toea)	3.5	35	56
Quantity (L)	0.1	1	1.6

Cost (toea)	35	56	560
Quantity (L)	1	1.6	16

**Important Point.**

Table 1 corresponds to Mero's idea and table 2 corresponds to Kekeni's idea. The two tables have in common is changing decimal numbers to whole numbers using the rule of division.

**Summary**

- We can find the answer using the rule of division even when the divisor is a decimal number.
- We can apply the unit idea when dividing with decimals.

### Sample Blackboard Plan (Lesson 39)

**Date:**    **Unit:** Division of Decimal Numbers    **Topic 1:** Operation of Whole Numbers  $\div$  Decimal Numbers    **Lesson Number:** 2 of 2

**MT:** Let's explain how to divide in vertical form.

**Review.**

**MT:** Introduce the main task here.

F. Let's explain how to divide  $320 \div 1.6$  in vertical form.

$$\begin{array}{r} 1.6 \overline{) 320} \\ \underline{\times 10} \phantom{0} \\ 16 \overline{) 3200} \end{array}$$

The rule of division can be applied to division of decimal numbers as well.

**Important Point.**

**2** There is a rectangular flower bed that has a width of 2.4 m long and has an area of  $12\text{m}^2$ . How long is the length in meter

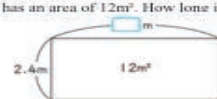

**1** Write a mathematical Expression.  $12 \div 2.4$

Let's think about how to calculate.

Write down student's ideas.

Let's think about how to divide in vertical form.

2.4	1	2	
$\times 10$	$\times 10$		
24	12	0	5
	12	0	
		0	

**Exercise:** Let's divide in vertical form.

(1)  $9 \div 1.8 = 5$

(2)  $91 \div 2.6 = 35$

(3)  $6 \div 4.8 = 1.25$

Calculate in vertical form.

**Summary**

We can apply the rule of division when dividing with decimals in vertical form.

**Sub-unit Objectives**

- To think about how to calculate decimal number ÷ decimal number.
- To understand and apply the steps on how to calculate decimal number ÷ decimal number in vertical form.
- To understand the relationship of the size between quotient and dividend.

**Lesson Objectives**

- To understand the meaning of decimal number ÷ decimal number.
- To understand how to calculate decimal number ÷ decimal number in vertical form.

**Prior Knowledge**

- Calculating Whole Number ÷ Decimal Number in vertical form
- How to calculate Whole Number ÷ Decimal Number
- Rules of division

**Preparation**

- Chart of tape diagram for task 1

**Assessment**

- Determine the meaning of decimal number ÷ decimal number. **F**
- Demonstrate the understanding on how to calculate decimal number ÷ decimal number in vertical form. **S**
- Solve the exercises correctly. **S**

**Teacher's Notes**

The point which is different from the division of a decimal number is that students don't have to put back the number again after getting the answer of calculation with the whole numbers. In short, it is using Naiko's idea of  $a \div b = (a \times 10) \div (b \times 10)$ .

**2 Operation of Decimal Numbers ÷ Decimal Numbers**

- 1 We used 5.76 dL of paint to paint a 3.2 m<sup>2</sup> wall.  
How many decilitre (dL) of paint will we use to paint a 1 m<sup>2</sup> wall?

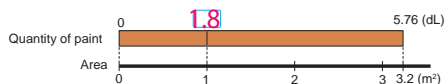

- 1 Let's write a mathematical expression.
- |                        |   |      |
|------------------------|---|------|
| Quantity of paint (dL) | ? | 5.76 |
| Area (m <sup>2</sup> ) | 1 | 3.2  |
- $5.76 \div 3.2$

- 2 Approximately how many dL will we use?  
 $6 \div 3 = 2$
- 3 Let's think about how to calculate.

How can we change it to division of whole numbers?

**Naiko's Idea**  
Paint needed for 0.1 m<sup>2</sup> is  $5.76 \div 32 = 0.18$  (dL).  
Paint needed for 1 m<sup>2</sup> will be 10 times of that, so  $0.18 \times 10 = 1.8$  (dL).

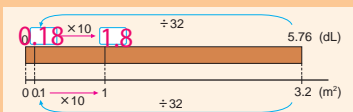

**Yamo's Idea**  
I will apply the rules of division to change the divisor into a whole number.

$5.76 \div 3.2 = 1.8$   
 $57.6 \div 32 = 1.8$

- 4 Let's think about how to divide in vertical form.

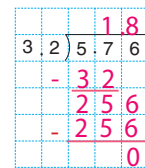

**How to Divide Decimal Numbers in Vertical Form**

- 1 Multiply the divisor by 10, 100 or more to make it a whole number and move the decimal point to the right accordingly.
- 2 Multiply the dividend by the same amount as the divisor and move the decimal point to the right accordingly.
- 3 The decimal point of the answer comes at the same place as where the decimal point of the dividend has been moved to.
- 4 Then, calculate as if this is the division of whole numbers.

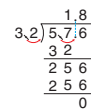

- 2 There is a rectangular flowerbed that has an area of 8.4 m<sup>2</sup> and the length of 2.8 m.  
How many metres is the width?

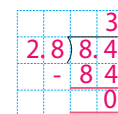

- 1 Let's write a mathematical expression.  
 $8.4 \div 2.8$
- 2 Let's calculate 1 in vertical form and find the answer.  
**Width is 3 m**

**Exercise**

Let's divide in vertical form.

- ①  $9.52 \div 3.4 = 2.8$     ②  $9.88 \div 2.6 = 3.8$     ③  $7.05 \div 1.5 = 4.7$   
④  $8.5 \div 1.7 = 5$     ⑤  $7.6 \div 1.9 = 4$     ⑥  $9.2 \div 2.3 = 4$



## Lesson Flow

**1** Review the previous lesson.

**2** Estimating the value of  $5.76 \div 3.2$

**T** Introduce the Main Task. (Refer to the BP)

**T/S** **1** Read and understand the situation.

**S** **1** Write a mathematical expression. ( $5.76 \div 3.2$ )

**TN** Let the students understand how to calculate division when both the divisor and dividend are decimal numbers.

**T** **2** Let's estimate the quantity of paint needed for  $1 \text{ m}^2$  by looking at the information on the number line and table.

**S** Paint needed for  $1 \text{ m}^2$  will be around ( $6 \div 3 = 2$ ) 2 dL.

**3** **3** Think about how to calculate  $5.76 \div 3.2$

**T** Let's compare Naiko's and Yamo's ideas. How can we change it to division of whole numbers?

**S** Discuss and present their ideas of how to calculate  $5.76 \div 3.2$

**TN** Naiko's Idea in calculating  $5.76 \div 3.2$  is expressing how to calculate by dividing (decimal number)  $\div$  (decimal number). Yamo's Idea in calculating  $5.76 \div 3.2$  uses the rules of division to divide.

**4** How to divide decimal numbers in vertical form.

**T** **4** Ask students to think about how to divide  $5.76 \div 3.2$  in vertical form.

**S** Discuss how to divide.

**T** Explain how to divide decimal numbers in vertical form in the box .

**5** Think about how to calculate  $8.4 \div 2.8$

**T/S** **2** Read and understand the situation.

**S** **1** Write a mathematical expression. ( $8.4 \div 2.8$ )

**S** **2** Divide  $8.4 \div 2.8$  in vertical form.

**T** Confirm the students calculation.

**6** Complete the Exercise

**S** Solve the selected exercises.

**T** Confirm students' answers.

**TN** Do the supplementary problems below if time allows for remedial purposes.

- 1.)  $7.5 \div 1.5$     2.)  $9.6 \div 1.6$     3.)  $9.6 \div 1.2$   
4.)  $8.4 \div 1.4$     5.)  $8.5 \div 1$

**7** Summary

**T** What have you learned in this lesson?

**S** Present ideas on what they have learned.

**T** Use students' ideas to confirm the important concepts of this lesson.

## Sample Blackboard Plan

**Date:**    **Unit:** Division of Decimal Numbers    **Topic 2:** Operation of Decimal Numbers  $\div$  Decimal Numbers    **Lesson Number:** 1 of 2

**MT:** Let's think and explain how to divide **Decimal Number  $\div$  Decimal Number** in vertical form.

**Review.**

**MT:** Introduce the main task here.

**1** We used 5.7dL of paint to paint a  $3.2\text{m}^2$  wall. How many dL of paint will we use to paint a  $1\text{m}^2$  wall?

Quantity of paint: 0, 1, 2, 3, 3.2(m<sup>2</sup>)

Quantity of paint(dL)	?	5.76
Area (m <sup>2</sup> )	1	3.2

**1** Write a mathematical Expression.  $5.76 \div 3.2$

**2** Approximately how many dL will we use?  $6 \div 3 = 2$   
**Answer:** 2 dL.

**3** Let's think about how to calculate.

**Naiko's Idea.**

Paint needed for  $0.1\text{m}^2$  is  $5.76 \div 32 = 0.18$  (dL),  
Paint needed for  $1\text{m}^2$  will be 10 times of that, so  $0.18 \times 10 = 1.8$  (dL).

**Yamo's Idea.**

I will apply the rules of division to change the divisor into a whole number.

$$\begin{array}{r} 5.76 \div 3.2 = 1.8 \\ \times 10 \quad \times 10 \\ \hline 57.6 \div 32 = 1.8 \end{array}$$

**4** Let's think about how to divide in vertical form.

			1.8	
3	2	5	7	6
-	3	2		
		2	5	6
-		2	5	6
				0

**How to Divide Decimal Numbers in Vertical Form:**

(1) Multiply the divisor by 10, 100, or more to make it a whole number, and move the decimal point to the right accordingly.

(2) Multiply the dividend by the same amount as the divisor, and move the decimal point to the right accordingly.

(3) The decimal point of the answer comes at the same place as where the decimal point of the dividend has been moved to.

(4) Then, calculate as if this is the division of whole numbers.

**5** There is a rectangular flower bed that has an area of  $8.4\text{m}^2$  and the length of  $2.8\text{m}$ . How many meters is the width?

**1** Write a mathematical expression.  $8.4 \div 2.8$

**2** Let's divide in vertical form.

			3
2	8	4	
-	8	4	
		0	

**Answer:** The width is 3 m.

**Exercise:** Let's divide in vertical form.

(1)  $9.52 \div 3.4 = 2.8$

(2)  $9.88 \div 2.6 = 3.8$

(3)  $7.05 \div 1.5 = 4.7$

**Calculate in vertical form.**

(4)  $8.5 \div 1.7 = 5$

(5)  $7.6 \div 1.9 = 4$

(6)  $9.2 \div 2.3 = 4$

**Summary**

To divide decimal numbers in vertical form, change divisors to whole numbers multiply dividend by same amount as divisor place the decimal point of answer where the decimal point of dividend has been moved then calculate

# Unit 5

## Unit: Division of Decimal Numbers Sub-unit 2: Operation of Decimal Numbers ÷ Decimal Numbers Lesson 2 of 2

Textbook Page : 064  
Actual Lesson 041

### Lesson Objectives

- To understand where to place zero (0) when doing continuous calculation with division.
- To understand and apply the calculation on division of decimal number ÷ decimal number.

### Prior Knowledge

- Calculating decimal Number ÷ decimal Number in vertical form
- How to calculate Decimal Number ÷ Decimal Number
- The rules of division
- Continuous division

### Preparation

- Tape diagram and table

### Assessment

- Think about where to place zero (0) when doing continuous calculation with division. **F**
- Solve the exercises correctly. **S**

### Teacher's Notes

#### Supplementary Exercise

Let's do the following divisions in vertical form.

- $3.4 \div 2.5$  [1.36]
- $4.62 \div 4.4$  [1.05]
- $5.33 \div 2.6$  [2.05]
- $1.68 \div 3.5$  [0.48]

### Calculating decimal number ÷ decimal number

- 3** A metal bar is 1.5 m and weighs 4.8 kg.  
How many kilograms (kg) will 1 m of this bar weigh?



- 1** Let's write a mathematical expression.

$$4.8 \div 1.5$$

- 2** Let's think about how to calculate.

- A** By what number should we multiply the divisor and the dividend?

**10**

- B** Think of 48 as 48.0 to continue with the division.

Weight (kg)	?	4.8
Length (m)	1	1.5

÷ 1.5

$$\begin{array}{r} 3.2 \\ 1.5 \overline{) 4.8.0} \\ \underline{4.5} \phantom{0} \\ 30 \\ \underline{-30} \\ 0 \end{array}$$

- 4** Let's think about how to divide  $3.23 \div 3.8$  in vertical form.



Why is there no quotient in the ones place?

$$\begin{array}{r} 0.85 \\ 3.8 \overline{) 3.23} \\ \underline{304} \\ 190 \\ \underline{190} \\ 0 \end{array}$$

**3.2 is not divisible by 3.8 so no quotient in the ones place**

#### Exercise

- 1** Let's divide in vertical form.

①  $36.9 \div 1.8$  **20.5**   ②  $3.06 \div 4.5$  **0.68**   ③  $0.49 \div 3.5$  **0.14**

- 2** There is a rectangular flowerbed that has an area of  $36.1 \text{ m}^2$ .  
How many m is the width if the length is 3.8 m?

$3.61 \div 3.8 = 9.5$    **Answer:  $9.5 \text{ m}^2$**

64 = □ × □

## Lesson Flow

**1** Review the previous lesson.

**2** Think about how to calculate  $4.8 \div 1.5$

**T** Introduce the Main Task. (Refer to the BP)

**T/S** **3** Read and understand the situation.

**T** Ask the students to use the tape diagram and the table to write the mathematical expression.

**S** **1** Write a mathematical expression as  $4.8 \div 1.5$

**3** **2** Calculate  $4.8 \div 1.5$  in vertical form.

**T/S** **A** Discuss the number that should be multiplied with the divisor and the dividend.

**S** 10

**S** **B** Consider 48 as 48.0 and continue with the division in vertical form and fill in the box .

**T** Confirm the vertical calculation.

**4** **4** Think about how to calculate  $3.23 \div 3.8$

**T** Let's think about how to divide  $3.23 \div 3.8$  in vertical form.

**T** When there is no quotient in the ones place, we continue to calculate by adding 0 to solve the problem.

**S** Identify and express ideas after solving the problem.

**5** Complete the Exercise

**S** Solve the selected exercises.

**T** Confirm students' answers.

**6** Summary

**T** What have you learned in this lesson?

**S** Present ideas on what they have learned.

**T** Use students' ideas to confirm the important concepts of this lesson.

## Sample Blackboard Plan

**Date:**      **Unit:** Division of Decimal Numbers      **Topic 2:** Operation of Decimal Numbers  $\div$  Decimal Numbers      **Lesson Number:** 2 of 2

**MT:** Let's Divide Decimal Number  $\div$  Decimal Number in vertical form.

**Review.**  
**MT:** Introduce the main task here.

**3** A metal bar is 1.5m and weighs 4.8kg. How many kg will 1m of this bar weigh?



Weight(kg)	4.8
Length(m)	1.5

**1** Write a mathematical Expression.  $4.8 \div 1.5$

**2** Let's think about how to calculate.

A. By what number should we multiply the divisor and the dividend? 10

B. Think of 48 as 48.0 to continue with the division.

$$\begin{array}{r} 3.2 \\ 1.5 \overline{) 4.80} \\ \underline{45} \phantom{0} \\ 30 \phantom{0} \\ \underline{30} \\ 0 \end{array}$$

**Answer:** 3.2

**4** Let's think about how to divide  $3.23 \div 3.8$  in vertical form.

$$\begin{array}{r} 0.85 \\ 3.8 \overline{) 3.23} \\ \underline{304} \phantom{0} \\ 190 \phantom{0} \\ \underline{190} \\ 0 \end{array}$$

Why is there no quotient in the ones place?

3.2 is not divisible by 3.8 therefore there is no quotient in the ones place.

**Exercise:**

1. Let's divide in vertical form.

(1)  $36.9 \div 1.8 = 20.5$       (2)  $3.06 \div 4.5 = 0.68$

(3)  $0.49 \div 3.5 = 0.14$

**Calculate in vertical form.**

2. There is a rectangular flower bed that has an area of 36.1 m<sup>2</sup>. How many meters is the width if the length is 3.8 m?

$3.61 \div 3.8 = 9.5$

**Answer:** 9.5 m

**Summary**

When there is no quotient in the ones place, we continue to calculate by adding 0 to complete the calculation.

P 83

# Unit 5

## Unit: Division of Decimal Numbers Sub-unit 3: Division Problems Lesson 1 of 2

Textbook Page :  
065  
Actual Lesson 042

### Sub-unit Objectives

- To understand how to calculate and confirm the answers of the divisions with remainders.
- To understand how to find the quotient by rounding.

### Lesson Objective

- To understand how to calculate and confirm the answers of the divisions with remainders.

### Prior Knowledge

- Dividing by Decimal Numbers Smaller than 1

### Preparation

- Diagram on 1

### Assessment

- Think about how to calculate and confirm the answers of the divisions with remainders. **F**
- Solve the exercises correctly. **S**

### Teacher's Notes

Note that in the division of vertical form, the remainder is 0.1 and not 1.

The simplest formula to prove in 3 is by using:

$$\text{Remainder} = \text{Dividend} - (\text{Divisor} \times \text{Quotient})$$

### 3 Division Problems

#### 1 Division with Remainders

- 1 I had 2.5 L of juice and poured 0.8 L into each bottle.  
How many bottles of 0.8 L of juice do I have now? How many Litres (L) of juice is left over?

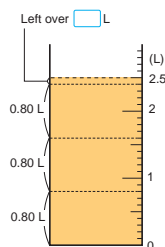

- 1 Let's write a mathematical expression.

$$2.5 \div 0.8$$

- 2 The calculation is shown on the right.  
If the left over is 1 L in this case, what will happen?  
Write down what you think.

$$\begin{array}{r} 3. \\ 0.8 \overline{) 2.5} \\ \underline{24} \\ 1 \end{array}$$

- 3 Where should we put the decimal point of the remainder?

When we calculate, we are assuming that 0.8 L is 8 dL and 2.5 L is 25 dL. That means the remainder 1 is actually...

$$\text{Dividend} = \text{Divisor} \times \text{Quotient} + \text{Remainder}$$

$$2.5 = 0.8 \times 3 + 0.1$$

Answer: 3 r 0.1



In division of decimal numbers, the decimal point of the remainder comes at the same place as the original decimal point of the dividend.

$$\begin{array}{r} 3. \\ 0.8 \overline{) 2.5} \\ \underline{24} \\ 0:1 \end{array}$$

#### Exercise

A 8 kg of rice is divided into bags of 1.5 kg.  
How many bags of 1.5 kg rice will be filled and how many kg of rice will be left over?

$$8 \div 1.5 = 5 \text{ remainder } 0.5 \quad 5 \text{ bags of } 1.5 \text{ kg rice}$$

$$8 - (5 \times 1.5) = 8 - 7.5 = 0.5 \text{ kg remaining}$$

$$\square - \square = 65$$

## Lesson Flow

### 1 Review the previous lesson.

**T** Solve  $4.5 \div 0.5$  and link to this lesson.

### 2 Solving division with the remainder 1 to be 0.1

**T/S** 1 Read and understand the situation.

**T** Introduce the Main Task. (Refer to the BP)

**T** Explain that the situation is similar to the review question but for this case it is different. There was 2.5 L of juice of which are poured into 0.8 L of bottles.

How many L of juice is left?

**S** 1 Write a mathematical expression:  $2.5 \div 0.8$

**S** 2 Think about how to explain the calculation of  $2.5 \div 0.8$  and what happens if the left over is 1 L.

**T** What will happen if the remainder is 1 L? Explain your answer.

**S** If remainder is 1 L, it will be greater than the divisor.

**TN** When we calculate, we are assuming that 0.8 L is 8 dL and 2.5 L is 25 dL by multiplying both the divisor and the dividend with 10.

**T** 3 Where should we put the decimal point of the remainder?

**S** Solve the calculation problem.

**TN** Use the checking to method confirm where the decimal point of the remainder should be placed.  
 $\text{Dividend} = \text{Divisor} \times \text{Quotient} + \text{Remainder}$   
 $2.5 = 0.8 \times 3 + 0.1$

### 3 Important Point

**T/S** Explain the important point in the box  

### 4 Complete the Exercise

**S** Solve the selected exercises.

**T** Confirm students' answers.

### 5 Summary

**T** What have you learned in this lesson?

**S** Present ideas on what they have learned.

**T** Use students' ideas to confirm the important concepts of this lesson.

## Sample Blackboard Plan

**Date:**    **Unit:** Division of Decimal Numbers    **Topic 3:** Division Problems    **Lesson Number:** 1 of 3

**MT:** Let's think about how to calculate and confirm the answer of the division with remainders.

**Review.**

**MT:** Introduce the main task here.

1 I have 2.5 L of juice and poured 0.8 into each bottle. How many bottles of 0.8 L of juice is left over?

1 Let's write an expression and calculate it.  
Expression:  $2.5 \div 0.8$

2 The calculation is shown on the right. If the left over is 1L in this case, what will happen? Write down what you think.  
The remainder greater than the divisor. It has to be smaller than the divisor.

3 Where should we put the decimal point of the remainder?  
Put the decimal point before 1 and it will be read as 0.1

$$\begin{array}{r} 3. \\ 0.8 \overline{) 2.5} \\ \underline{24} \\ 01 \end{array}$$

3 remainder 0.1  
Answer: 3 bottles of 0.8 L and 0.1 L juice is left over.

**Dividend = Divisor × Quotient + Remainder**  
 $2.5 = 0.8 \times 3 + 0.1$

**Important Point.**

**Exercise:**  
There is a 8kg of rice which is divided into bags of 1.5kg. How many bags of 1.5 kg rice will be filled and how many kg of rice will be left over?

$8 \div 1.5 = 5$  remainder 0.5  
Answer: 5 bags of 1.5 kg rice and 0.5 kg remaining or left over.

**Dividend = Divisor × Quotient + Remainder**  
 $8 = 1.5 \times 5 + 0.5$

**Summary**

- The remainder should always than the divisor.
- Place the decimal point of the remainder at the same place of the decimal point of the dividend.

P 81

# Unit 5

## Unit: Division of Decimal Numbers Sub-unit 3: Division Problems Lesson 2 of 2

Textbook Page :  
066  
Actual Lesson 043

### Lesson Objective

- To understand how to find the quotient by rounding.

### Prior Knowledge

- Division with Remainder
- Adding 0 to continue the calculation

### Preparation

- Chart of calculation of long division in 2

### Assessment

- Think about how to find the quotient by rounding.  
**F**
- Solve the exercises correctly. **S**

### Teacher's Notes

The term 'not divisible' in the summary means that when the remainder is continuous, we have to round the quotient.

- 2 I weighed a 2.4 m long metal bar and it weighed 2.84 kg.  
How many kg does 1 m of this bar weigh?

- 1 Let's write an expression.

$$2.84 \div 2.4$$

- 2 The calculation carried out is shown on the right.

What will be the answer?

- 3 Round the quotient to the thousandths place and give the answer to the nearest hundredth. **1.18 kg**

$$\begin{array}{r} 1.183 \\ 2.4 \overline{) 2.84} \\ \underline{2.4} \phantom{0} \\ 44 \\ \underline{24} \phantom{0} \\ 200 \\ \underline{192} \phantom{0} \\ 80 \\ \underline{72} \\ 8 \end{array}$$



When a remainder is not divisible by the divisor or when the numbers become too long, the quotient is rounded.

#### Exercise

- 1 For answering the quotient at the nearest hundredths place, round the quotient to the thousandths place.

①  $2.8 \div 1.7$  **1.65**    ②  $5 \div 2.1$  **2.38**    ③  $9.4 \div 3$  **3.13**  
④  $61.5 \div 8.7$  **7.07**    ⑤  $0.58 \div 2.3$  **0.25**    ⑥  $19.2 \div 0.49$  **39.18**

- 2 A 0.3 m wire weighs 1.6 g. Approximately, how many g does 1 m of this wire weigh? For answering the quotient at the nearest tenths place, round the quotient to the hundredths place.

$$1.6 \div 0.3 = 5.33$$

Answer: 5.33 g

66 = □ × □

## Lesson Flow

**1** Review the previous lesson.

**2** Rounding the quotient when the remainder is not divisible.

- T/S **2** Read and understand the given situation.
- T Introduce the Main Task. (Refer to the Blackboard Plan)
- T Ask students to write a mathematical expression.
- S **1** Write a mathematical expression as  $2.84 \div 2.4$
- T **2** Explain the calculation  $2.84 \div 2.4$  in the vertical form.
- S Observe the calculation process.
- T What will be the answer?
- T/S Discuss the answers together.

**3** Think about how to round the quotient to the nearest place value.

- TN The quotient is continuous 1.183333.....therefore, we need to round the quotient.
- T **3** Let students round the quotient to the thousandths place and give the answer to the nearest hundredths.
- S The quotient is 1.183.... so we round off to 1.18
- S The answer is 1.18 kg when rounded to the nearest hundredths.

**4** Important Point

- T/S Explain the important point in the box  .

**6** Complete the Exercise

- S Solve the selected exercises.
- T Confirm students' answers.

**7** Summary

- T What have you learned in this lesson?
- S Present ideas on what they have learned.
- T Use students' ideas to confirm the important concepts of this lesson.

## Sample Blackboard Plan

**Date:**    **Unit:** Division of Decimal Numbers    **Topic 3:** Division Problems    **Lesson Number:** 2 of 3

**MT:** Let's think about how to round the quotient when the remainder is not divisible by the divisor.

**Review:**

**MT:** Introduce the main task here.

**2** I weighed a 2.4m long metal bar and it was 2.84kg. How many kg does 1m of this bar weigh?

- Let's write an expression and calculate it.  
Expression:  $2.84 \div 2.4$
- The calculation is shown on the right. What will be the answer?

$$\begin{array}{r}
 1.183 \\
 2.4 \overline{) 2.84} \\
 \underline{24} \phantom{0} \\
 44 \\
 \underline{44} \\
 00 \\
 \underline{00} \\
 00 \\
 \underline{00} \\
 00 \\
 \underline{00} \\
 00 \\
 \underline{00} \\
 00
 \end{array}$$

Write down what students think will be the answer.

● Round the quotient to the thousandths place and give the answer to the nearest hundredth.  
**Answer:** 1.18 kg

**Important Point.**

**Exercise:**

1 For answering the quotient at the nearest hundredth point, round the quotient to the thousandth place.

①  $2.8 \div 1.7 = 1.65$     ②  $5 \div 2.1 = 2.38$     ③  $9.4 \div 3 = 3.13$   
 ④  $61.5 \div 8.7 = 7.07$     ⑤  $0.58 \div 2.3 = 0.25$     ⑥  $19.2 \div 0.49 = 39.18$

2 0.3m of a wire weighs 1.6g. Approximately how many g does 1m of this wire weigh? For answering the quotient at the nearest tenth place, round the quotient to the hundredth place.  $1.6 \div 0.3 = 5.33$   
**Answer:** 5.33 g

**Summary**  
We round the quotient when a remainder is not divisible by the divisor or when the number become too long.

# Unit 5

## Unit: Division of Decimal Numbers Sub-unit 3: Division Problems Lesson 1 of 1

Textbook Page :  
067  
Actual Lesson 044

### Lesson Objective

- To think about the relationship between the quotient and the dividend when dividing by decimal numbers smaller than 1.

### Prior Knowledge

- How to divide Decimal Numbers in Vertical Form
- Adding 0 to continue the calculation

### Preparation

- Chart of tape diagrams for task 3

### Assessment

- Think about the relationship between the quotient and the dividend. **F**
- Think about how to divide decimal numbers smaller than 1 and notice the change in the quotient and the dividend. **F**
- Solve the exercises correctly. **S**

### Teacher's Notes

#### Supplementary Problems

1. Which expressions give the quotients bigger than 24?

- a)  $24 \div 2.5$     b)  $24 \div 0.1$     c)  $24 \div 0.8$   
d)  $24 \div 1.2$     e)  $24 \div 1.05$     f)  $24 \div 0.96$

Answer: [ b, c, f ]

#### Dividing by Decimal Numbers Smaller than 1

- 3 There is a thin wire that is 1.2 m long which weighs 8.4 g and a thick wire that is 0.8 m long and weighs 9.6 g. Let's find the weight of 1 m for each wire.

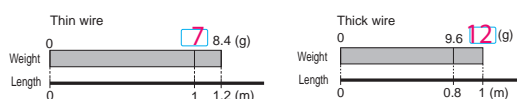

- How many g does 1 m of the thin wire weigh? Write an expression and calculate it.  $8.4 \div 1.2$
- How many g does 1 m of the thick wire weigh? Write an expression and calculate it.  $9.6 \div 0.8$
- Let's compare the quotients and dividends of each of them.
- Let's calculate  $9.6 \div \square$  by putting numbers into the  $\square$  apart from 0.8. Let's talk about what you noticed.

$9.6 \div 1 = 9.6$	$9.6 \div 0.6 = 16$	$9.6 \div 0.2 = 48$
$9.6 \div 0.9 = 10.66$	$9.6 \div 0.5 = 19.2$	$9.6 \div 0.1 = 96$
$9.6 \div 0.8 = 12$	$9.6 \div 0.4 = 24$	
$9.6 \div 0.7 = 13.7$	$9.6 \div 0.3 = 32$	



When a number is divided by a number smaller than 1, the quotient becomes larger than the dividend.

#### Exercise

Let's divide in vertical form.

- ①  $4.9 \div 0.7 = 7$     ②  $3.2 \div 0.4 = 8$     ③  $1.5 \div 0.3 = 5$   
④  $0.9 \div 0.6 = 1.5$     ⑤  $0.4 \div 0.5 = 0.8$     ⑥  $0.2 \div 0.8 = 0.25$

$\square - \square = 67$



## Lesson Flow

**1** Review the previous lesson.

**2** Dividing by decimal numbers smaller than 1.

**T/S** **3** Read and understand the given situation.

**T** Introduce the Main Task. (Refer to the Blackboard Plan)

**T** Ask the students to use the tape diagram to write the mathematical expressions.

**S** **1** Write the mathematical expression of the thin wire and calculate.

Expression:  $8.4 \div 1.2$      Answer:  $8.4 \div 1.2 = 7$

**S** **2** Write the mathematical expression of the thick wire and calculate.

Expression:  $9.6 \div 0.8$      Answer:  $9.6 \div 0.8 = 12$

**T/S** Confirm calculations using the rule of division and fill in the boxes in the tape diagrams.

**T** **3** Let's compare the quotients and the dividends in **1** and **2**.

**S** In **1** the quotient (7) is less than the dividend (8.4)

In **2** the quotient (12) is greater than the dividend (9.6)

**3** Understand the relationship amongst the divisor, dividend and quotient.

**S** **4** Calculate and fill in the box .

**T** Discuss what you noticed amongst the divisors, dividends and the quotients.

**S** The quotient becomes larger than the dividend as the divisor decreases.

**4** Important Point

**T/S** Explain the important point in the box .

**5** Complete the Exercise

**S** Solve the selected exercises.

**T** Confirm students' answers.

**6** Summary

**T** What have you learned in this lesson?

**S** Present ideas on what they have learned.

**T** Use students' ideas to confirm the important concepts of this lesson.

## Sample Blackboard Plan

Date:     Unit: Division of Decimal Numbers
Topic 3: Division Problems
Lesson Number: 3 of 3

**MT:** Let's divide decimal numbers smaller than 1 and find the relationship between the quotient and the dividend.

**Review.**

**MT:** Introduce the main task here.

**3** There is a thin wire that is 1.2 m and 8.4 g and a thick wire that is 0.8 m and 9.6 g. Let's find the weight of 1m for each wire.

Thin wire

Thick wire

**1** How many g does 1 m of the thin wire weigh? Write an expression and calculate it. **Expression:**  $8.4 \div 1.2$   
 $8.4 \div 1.2 = 7$  **Answer:** 7g

**2** How many g does 1 m of the thick wire weigh? Write an expression and calculate it. **Expression:**  $9.6 \div 0.8$   
 $9.6 \div 0.8 = 12$  **Answer:** 12 g.

**3** Let's compare the quotient and dividend for each of them.  
In **1** the quotient is less than the dividend.  
In **2** the quotient is greater than the dividend.

**4** Let's calculate  $9.6 \div \square$  by putting numbers into the  apart from 0.8 Let's talk about what you noticed.

$9.6 \div 1 = 9.6$	$9.6 \div 0.6 = 16$	$9.6 \div 0.2 = 48$
$9.6 \div 0.9 = 10.66$	$9.6 \div 0.5 = 19.2$	$9.6 \div 0.1 = 96$
$9.6 \div 0.8 = 12$	$9.6 \div 0.4 = 24$	
$9.6 \div 0.7 = 13.7$	$9.6 \div 0.3 = 32$	

Write down what the students have noticed.

**Important Point.**

**Exercise:**

Let's divide in vertical form.

- (1)  $4.9 \div 0.7 = 7$
- (2)  $3.2 \div 0.4 = 8$
- (3)  $1.5 \div 0.3 = 5$
- (4)  $0.9 \div 0.6 = 1.5$
- (5)  $0.4 \div 0.5 = 0.8$
- (6)  $0.2 \div 0.8 = 0.25$

Calculate in vertical form.

**Summary**

When a number is divided by a number smaller than 1, the quotient becomes larger than the dividend.

# Unit 5

## Unit: Division of Decimal Numbers

Sub-unit 4: What kind of Calculation Would It Be? Draw Diagrams to Help You Think  
Lesson 1 of 1

Textbook Page :  
068 and 069  
Actual Lesson 045

### Sub-unit Objectives

- To understand the relationship between multiplication and division and decide which operation to be used.
- To deepen understanding through creating multiplication and division problems.

### Lesson Objectives

- To understand word problems of multiplication and division of decimal numbers and identify which operation to use.
- To create multiplication and division word problems using samples.

### Prior Knowledge

- Previous lesson
- Amount per unit quantity

### Preparation

- Tape diagrams and tables for **1**, **2** and **3**

### Assessment

- Think about the relationship between multiplication and division of different problems. **F**
- Think about which operation to use and solve the problems. **F**
- Create multiplication and division word problems. **S**

### Teacher's Notes

It is important to use the tape diagram and the table for each task to enhance students ability in solving multiplication and division problems.

#### 4 What Kind of Calculation Would It Be? Draw Diagrams to Help You Think

- 1** Minie watered a 1 m<sup>2</sup> flowerbed with 2.4 L of water.  
How many L of water will she use to water a 1.5 m<sup>2</sup> flowerbed?

Estimation : Water needed for 1.5 m<sup>2</sup> will probably be more than the water for 1 m<sup>2</sup>.

Amount of 1 unit	Total Amount
Volume of water (L)	2.4
Area (m <sup>2</sup> )	1

Volume of water (L)	2.4	?
Area (m <sup>2</sup> )	1	1.5

Expression :  $2.4 \times 1.5 = 3.6$  Answer **3.6** L

- 3** Lyn used 2.4 L of water to water 1 m<sup>2</sup> flowerbed.  
How many m<sup>2</sup> can she water with 8.4 L?

Approach : Use the amount of 1 unit size to calculate the number of unit sizes.

Amount of 1 unit	Total Amount
Volume of water (L)	2.4
Area (m <sup>2</sup> )	1

Volume of water (L)	2.4	8.4
Area (m <sup>2</sup> )	1	?

Expression :  $8.4 \div 2.4 = 3.5$  Answer **3.5** m<sup>2</sup>

- 2** Jack used 4 L of water to water 2.5 m<sup>2</sup>.  
How many L will he use to water 1 m<sup>2</sup>?

Approach : We want to know the amount of 1 unit size, so we use division.

Amount of 1 unit	Total Amount
Volume of water (L)	4
Area (m <sup>2</sup> )	2.5

Volume of water (L)	?	4
Area (m <sup>2</sup> )	1	2.5

Expression :  $4 \div 2.5 = 1.6$  Answer **1.6** L

- 4** Ben wrote the following questions.

There is a solar panel that weighs 2.5 kg for 1 m<sup>2</sup>.  
The weight of 3.8 m<sup>2</sup> of this panel is 9.5 kg.  
Let's fill in the  with an appropriate number.

- Fill in the .
- Let's make a multiplication problem by changing the numbers and words.
- Let's make a division problem by changing the numbers and words.

## Lesson Flow

**1** Review the previous lesson.

**2** Using multiplication as an operation to solve the problem.

**T** Introduce the Main Task. (Refer to the BP)

**T/S** **1** Read and understand the situation.

**T** Which operation is used in this situation and write a mathematical expression.

**S** Use the tape diagram and table to identify the operation. Write a mathematical expression and calculate.

Expression:  $2.4 \times 1.5$

Answer:  $2.4 \times 1.5 = 3.6$  L

**T** Confirm the calculation using the tape diagram and the table of information.

**3** Using division as an operation to solve the problem.

**T/S** **2** Read and understand the situation.

**T** Which operation is used in this situation and write a mathematical expression.

**S** Use the tape diagram and table to identify the operation. Write a mathematical expression and calculate.

Expression:  $4 \div 2.5$

Answer:  $4 \div 2.5 = 1.6$  L

**T** Confirm the calculation using the tape diagram and the table of information.

**4** Using division as an operation to solve the problem.

**T/S** **3** Read and understand the situation.

**T** Which operation is used in this situation and write a mathematical expression.

**S** Use the tape diagram and table to identify the operation. Write a mathematical expression and calculate.

Expression:  $8.4 \div 2.4$

Answer:  $8.4 \div 2.4 = 3.5$  m<sup>2</sup>

**T** Confirm the calculation using the tape diagram and the table of information.

**5** Make multiplication and division word problems.

**T/S** **4** Read and understand the situation.

**S** **1** Fill in the box  for the situation.

**S** **2** Make multiplication word problems by changing the numbers and words.

**S** **3** Make division word problems by changing the numbers and words.

**T** Confirm the activities **1**, **2** and **3**.

**6** Summary

**T** What have you learned in this lesson?

**S** Present ideas on what they have learned.

**T** Use students' ideas to confirm the important concepts of this lesson.

## Sample Blackboard Plan

**Date:**      **Unit:** Division of Decimal Numbers      **Topic 4:** What kind of Calculation would it be?      **Lesson Number:** 1 of 1

**MT:** Let's think about what kind of calculation would it be?

**Review.**

**MT:** Introduce the main task here.

**1** I watered a 1m<sup>2</sup> flower bed with 2.4 L of water. How many L of water will I use to water a 1.5m<sup>2</sup> flower bed?

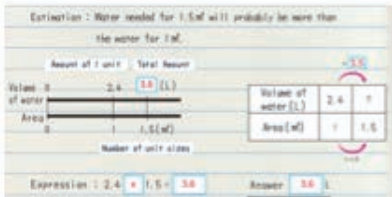

**3** I used 4 L of water to water 2.5m<sup>2</sup>. How many L will I use to water 1 m<sup>2</sup>?

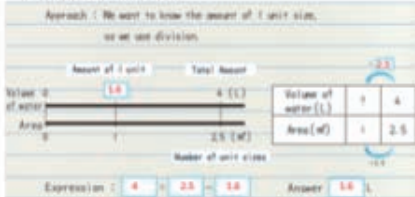

**2** I used 2.4 L of water to water 1 m<sup>2</sup>. How many m<sup>2</sup> can I water with 8.4 L?

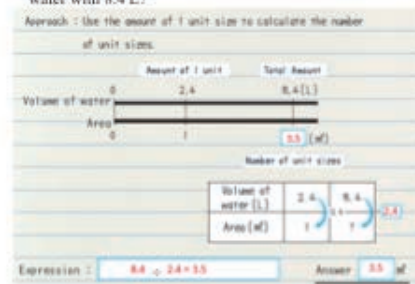

**4** Ben made the following question.

There is a panel that weighs 2.5kg for 1m<sup>2</sup>. The weight of 3.8m<sup>2</sup> of this panel is 9.5 kg. Let's fill the  by an appropriate number.

- Fill in the .
- Let's make a multiplication problem by changing the numbers and words. There is an apple basket that weighs 3.4kg for 1 basket. The weight of 2 and a half basket is 8.5kg.
- Let's make a division problem by changing the numbers and words. There is a plastic container that can water 3.6 m<sup>2</sup> of flower garden in 3 sprinkles. In one sprinkle it can water  m<sup>2</sup>.

**Summary**

- Use of tape diagrams and tables can help to identify the types of operations to use in solving problems.
- We can make multiplication and division word problems

P.91

# Unit 5

## Unit: Division of Decimal Numbers Exercise, Problems and Evaluation Lesson 1 and 2 of 2

Textbook Page :  
070 and 071  
Actual Lesson 046 and 047

### Lesson Objective

- To confirm their understanding on the concepts they learned in this unit by completing the Exercise, Problems and the Evaluation Test confidently.

### Prior Knowledge

- All the contents covered in this unit

### Preparation

- Evaluation test copy for each student

### Assessment

- Complete the Exercise and Problems correctly. **S**

### Teacher's Notes

This is the last lesson of Chapter 5. Students should be encouraged to use the necessary skills learned in this unit to complete all the Exercises and solve the Problems in preparation for the evaluation test. The test can be conducted as assessment for your class after completing all the exercises. Use the attached evaluation test to conduct assessment for your class after finishing all the exercises and problems as a separate lesson.

### EXERCISE

- 1 Let's divide in vertical form. Pages 58 to 69
- |                               |                               |                                |
|-------------------------------|-------------------------------|--------------------------------|
| ① $12 \div 1.5$ <b>8</b>      | ② $36 \div 1.8$ <b>20</b>     | ③ $40 \div 1.6$ <b>2.5</b>     |
| ④ $7.2 \div 2.4$ <b>3</b>     | ⑤ $9.8 \div 1.4$ <b>7</b>     | ⑥ $8.1 \div 2.7$ <b>3</b>      |
| ⑦ $7.2 \div 0.9$ <b>8</b>     | ⑧ $8.4 \div 0.6$ <b>14</b>    | ⑨ $0.3 \div 0.8$ <b>0.375</b>  |
| ⑩ $9.1 \div 3.5$ <b>2.6</b>   | ⑪ $5.4 \div 1.2$ <b>4.5</b>   | ⑫ $2.2 \div 5.5$ <b>0.4</b>    |
| ⑬ $0.87 \div 0.6$ <b>1.45</b> | ⑭ $14.8 \div 1.6$ <b>9.25</b> | ⑮ $0.12 \div 0.48$ <b>0.25</b> |

- 2 Let's find the quotient within whole numbers and give also the remainders. Pages 65 and 66
- |                  |                    |                   |
|------------------|--------------------|-------------------|
| ① $9.8 \div 0.6$ | ② $6.23 \div 0.23$ | ③ $9.72 \div 1.6$ |
| <b>16 r 0.2</b>  | <b>27 r 0.02</b>   | <b>6 r 0.12</b>   |

- 3 I poured 3.4 L of juice into cups of 0.8 L each. How many cups of 0.8 L juice will I have and how many L of juice will be left over? Pages 65 and 65
- 4 cups of 0.8 L juice and 0.25 L will be left.**

- 4 For answering the quotient to the nearest hundredths place, round the quotient to the thousandths place. Page 66
- |                   |                   |                    |
|-------------------|-------------------|--------------------|
| ① $0.84 \div 1.8$ | ② $5.18 \div 2.4$ | ③ $8.07 \div 0.96$ |
| <b>0.467</b>      | <b>2.158</b>      | <b>8.406</b>       |
| <b>0.47</b>       | <b>2.16</b>       | <b>8.41</b>        |

- 5 There is a wire 0.7 m long that weighs 5.8 g. About how many g will 1 m of this wire weigh? To answer the quotient at the nearest tenths place, round the quotient to the hundredths place. Page 67
- 8.92 g = 8.3 g**

Let's find the area of the following figures.

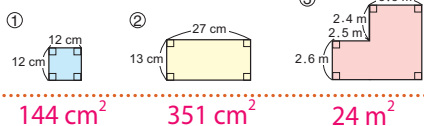

① **144 cm<sup>2</sup>**

② **351 cm<sup>2</sup>**

③ **24 m<sup>2</sup>**

70 = □ × □

### PROBLEMS

- 1 Let's divide in vertical form. Dividing decimal numbers by decimal numbers.
- |                               |                                |                                 |
|-------------------------------|--------------------------------|---------------------------------|
| ① $39.1 \div 1.7$ <b>23</b>   | ② $6.5 \div 2.6$ <b>2.5</b>    | ③ $29.4 \div 0.3$ <b>98</b>     |
| ④ $4.23 \div 1.8$ <b>2.35</b> | ⑤ $0.99 \div 1.2$ <b>0.825</b> | ⑥ $0.15 \div 0.08$ <b>1.875</b> |
- 2 There is a rectangular flowerbed that is 17.1 m<sup>2</sup> and the length is 3.8 m. What is the width in metres? **4.5 m** Calculating the length of sides from the area.
- 3 We distributed 3 L of milk into 0.18 L per cup. How many cups can we fill? How many litres of milk will be left over? **16 cups of 0.18 L juice and 0.12 L will be left.** Calculating the decimal number with remainder.
- 4 4.5 L of paint weighed 3.6 kg. What are the meanings of the following expressions? Considering relationship between the dividend and the divisor.
- |                  |  |
|------------------|--|
| ① $4.5 \div 3.6$ | ② $3.6 \div 4.5$                       |
|                  | <b>(1) amount of red beans per kg.</b> |
- 5 Which is greater? **(2) weight of red beans per L.** Let's fill in the □ with inequality signs. Understanding the relationship between the divisor and the quotient.
- |                                  |                                  |
|----------------------------------|----------------------------------|
| ① $125 \div 0.8$ <b>&gt;</b> 125 | ② $125 \div 1.2$ <b>&lt;</b> 125 |
|----------------------------------|----------------------------------|
- 6 Let's explain how to calculate  $6.21 \div 2.3$ . Why did you calculate like that? **53** Let's write the reasons which you used. Using calculation rules to explain.

□ - □ - 71

## Lesson Flow

### 1 Complete the Exercise

- S Solve all the exercises.
- T Confirm students' answers.
- TN
  - ① Division in vertical form.
  - ② Find the quotient within the whole numbers with its remainder.
  - ③ Division word problem.
  - ④ Rounding in division problems.
  - ⑤ Word problem involving division.

### 2 Solve the Problems

- S Solve all the problems.
- T Confirm students' answers.
- TN
  - ① Dividing decimal numbers by decimal numbers.
  - ② Calculating the length of sides from the area.
  - ③ Calculating the decimal numbers with the remainder.

- ④ Considering the relationship between the dividend and the divisor.
- ⑤ Understanding the relationship between the divisor and the quotient.
- ⑥ Using calculation rule to explain.

### 3 Complete the Evaluation Test

- TN Use the attached evaluation test to conduct assesment for your class after finishing all the exercises and problems as a seperate lesson.
- S Complete the Evaluation Test.

**End of Chapter Test:** **Date:** \_\_\_\_\_

Chapter 5: Division of Decimal Numbers	Name: _____	Score / 100
---	-------------	----------------

1. Calculate . [2 x 10 marks = 20 marks]

(1)  $72 \div 0.8$  (2)  $38.5 \div 0.7$

Answer: 90 Answer: 55

2. Calculate and find the quotient in integer and remainder. [2 x 10 marks = 20 marks]

(3)  $51.8 \div 6.3$  (4)  $12.4 \div 0.3$

Answer: 8 remainder 1.4 Answer: 4 remainder 0.1

3. Calculate and find the quotient with 1 decimal place by rounding.. [2 x 10 marks = 20 marks]

(3)  $67.3 \div 9.3$  (2)  $10.8 \div 3.2$

Answer: 7.2 Answer: 3.4

4. Which expressions give greater answer than 59? Find all expressions without calculating and the reasons. [2 x 10 marks = 20 marks]

(a)  $59 \div 1.7$  (2)  $59 \div 1.07$

(c)  $59 \div 0.9$  (d)  $59 \div 0.99$

Answer: (c) and (d) Reason: Divisor is less than 1

5. The length of a rope is 37.6 m. How many ropes of 0.6m will be cut and how long remaining? [10 marks for maths expression and 10 marks for answer]

Answer:  $37.6 \div 0.6$

Reason: 60 ropes and 0.16m remaining

96

# Unit 5

## Unit: Division of Decimal Numbers Sub-unit: Comparing Heights Lesson 1 of 1

Textbook Page :  
072 and 073  
Actual Lesson 048

### Sub-unit Objective

- Comparing heights by division and multiplication.

### Lesson Objective

- Compare the heights by division and multiplication.

### Prior Knowledge

- Topics covered in the previous lessons

### Preparation

- Chart of diagram of the cassavas
- Tables and bar graphs for **1** and **2**

### Assessment

- Derive mathematical expressions correctly using the tables and the bar graphs. **F**
- Compare the height of cassava and solve the mathematical expressions. **S**

### Teacher's Notes

This sub unit is focused on the application of the contents learned in this unit.

#### Comparing Lengths

1 There are 4 different sizes of Cassava .

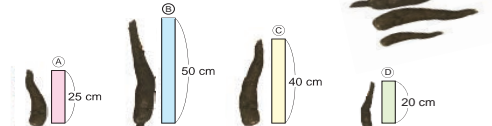

1 By how many times is the length of A compared to B?

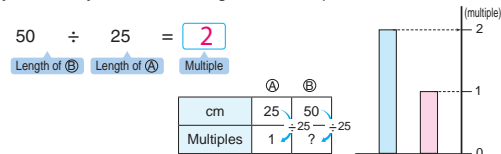

2 By how many times is the length of A compared to C?

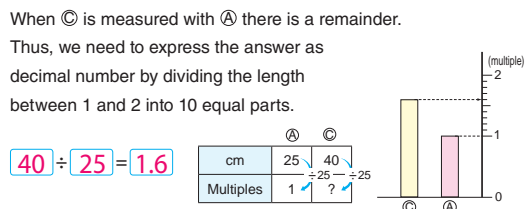

3 By how many times is the length A to D?

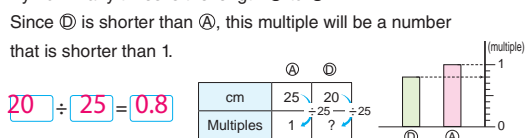

72 = □ × □

2 We are going to draw pictures of cassava based on cassava C.

1 If we draw a cassava twice the height of C, what will be the length of the new cassava?

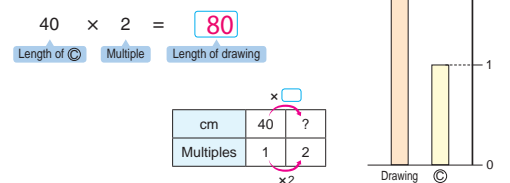

2 To make the drawing of the cassava 1.5 times the length of C, how many cm should it be?

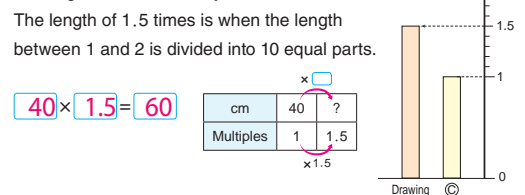

3 To make the drawing of the cassava 0.6 times the length of C, how many cm should it be? The length multiplied by 0.6 will become smaller than when it is multiplied by 1, so it will be smaller than the original length.

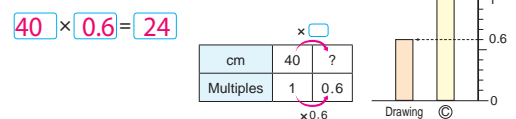

□ - □ = 73

## Lesson Flow

### 1 Comparison by division.

- T** Introduce the Main Task. (Refer to the BP).
- TS** Read and understand the situation.
- S** **1** Observe the height of each cassava and make comparison between the heights.
- T** **1** By how many times is the length of **A** compared to **B**?
- S** Use the table and the graph by comparison,  $50 \div 25 = 2$ . So height of **B** is 2 times than the height of **A**.

### 2 Comparison by continuous division in vertical form.

- T** **2** By how many times is the height of **C** to **A**?
- TN** When **C** is measured with **A**, there is a remainder so we need to express the remainder as a decimal number by dividing the height between 1 and 2 into 10 equal parts.
- S** Use the table to find the mathematical expression.  $40 \div 25$
- S** Solve the mathematical expression.  $40 \div 25 = 1.6$ . So height of **C** is 1.6 times the height of **A**.
- T** **3** By how many times is the height **D** to **A**?
- TN** Since **D** is shorter than **A**, this multiple will be a number that is less than 1.
- S** Use the table to find the mathematical expression.  $20 \div 25$

- S** Solve the mathematical expression.  $20 \div 25 = 0.8$  So height of **D** is shorter than **A** by 0.8 times.

### 3 Drawing pictures of cassava based on cassava **C**.

- T** **1** If we draw a cassava twice the height of **C**, what will be the height of the new cassava?
- S**  $40 \times 2 = 80$   
Answer: 80 cm.
- T** **2** To make the drawing of cassava 1.5 times the height of **C**, how many cm should it be?
- TN** The height of 1.5 times is when the height between 1 and 2 is divided into 10 equal parts.
- S**  $40 \times 1.5 = 60$   
Answer: 60 cm.
- T** **3** To make the drawing of cassava 0.6 times the height of **C**, how many cm should it be?
- TN** The height multiplied by 0.6 will become smaller than when it is multiplied by 1, so it will be smaller than the original height.
- S**  $40 \times 0.6 = 24$   
Answer: 24 cm

### 4 Summary

- T** What have you learned in this lesson?
- S** Present ideas on what they have learned.
- T** Use students' ideas to confirm the important concepts of this lesson.

## Sample Blackboard Plan

**Date:**    **Unit:** Division of Decimal Numbers    **Topic:** Comparing Heights    **Lesson Number:** 1 of 1

**MT: Let's compare and calculate the heights in different situations.**

**MT: Introduce the main task here.**

**1** There are 4 different sizes of cassava.

**1** By how many times is the length of **A** to **B**?

$50 \div 25 = 2$

Height of <b>A</b>	Height of <b>B</b>	Multiple
25	50	2
Multiple	1	2

**2** We are going to draw pictures of cassava based on cassava **C**.

**1** If we draw a cassava twice the height of **C**, what will be the height of the new cassava?

$40 \times 2 = 80$

Height of <b>C</b>	Multiple	Height of new
40	2	80
Multiple	1	2

**2** To make the drawing of the cassava 1.5 times the height of **C**, how many cm should it be? The height of 1.5 times, is when the length between 1 and 2 is divided into 10 equal parts.

$40 \times 1.5 = 60$

Height of <b>C</b>	Multiple	Height of new
40	1.5	60
Multiple	1	1.5

**3** To make the drawing of the cassava 0.6 times the height of **C**, how many cm should it be? The height multiplied by 0.6 will become smaller than when it is multiplied by 1, so it will be smaller than the original height.

$40 \times 0.6 = 24$

Height of <b>C</b>	Multiple	Height of new
40	0.6	24
Multiple	1	0.6

**Summary**  
We can calculate the unknown using the idea of unit 1 and divide or multiply with the known.

**End of Chapter Test****Date:**

Chapter 5: Division of Decimal Numbers	Name:	Score / 100
---	-------	----------------

1. Calculate.

[2 × 10 marks = 20 marks]

(1)  $72 \div 0.8$

Answer:

(2)  $38.5 \div 0.7$

Answer:

2. Calculate and find the quotient in integer and remainder.

[2 × 10 marks = 20 marks]

(1)  $51.8 \div 6.3$

Answer:

(2)  $12.4 \div 0.3$

Answer:

3. Calculate and find the quotient with 1 decimal place by rounding.

[2 × 10 marks = 20 marks]

(1)  $67.3 \div 9.3$

Answer:

(2)  $10.8 \div 3.2$

Answer:

4. Which expressions give greater answer than 59? Find all expressions without calculating and the reasons.

[2 × 10 marks = 20 marks]

(1)  $59 \div 1.7$

(2)  $59 \div 1.07$

(3)  $59 \div 0.9$

(4)  $59 \div 0.99$

Answer:

Reason:

5. The length of a rope is 37.6 m.

How many ropes of 0.6 m will be cut and how long will remain?

[10 marks for maths expression and 10 marks for answer]

Answer:

Reason:



# Chapter 6 Volume

## 1. Content Standard

5.2.2 Understand the units of volume and develop the formula of volume and measure.

## 2. Unit Objectives

- To get the interest about volume around us and find their volume.
- To enjoy finding the volume of objects around us for understanding the concept of volume.  
To understand how to find the volume of a rectangular prism and cube and combined shape.
- To understand the meaning of formula for finding the volume of rectangular prism and cube.

## 3. Teaching Overview

Students already have the concept of some quantities such as length, weight and area.

They also have the foundation of volume in Grade 2 through measuring activities.

They learn volume with universal unit of  $1 \text{ cm}^3$  in this unit.

### Volume :

Students understand the volume by comparing the sizes of several boxes.

When  $1 \text{ cm}^3$  is introduced, they will know that volume can be compared by the numbers of the universal unit.

### Formula for volumes :

Students should understand why the formula is true and understand the conservation of volume by making boxes of  $200 \text{ cm}^3$ .

### Large Volumes :

Students should be able to explain how large volumes with  $\text{m}^3$  are when  $1 \text{ m}^3$  is introduced.

## 4. Related Learning Contents

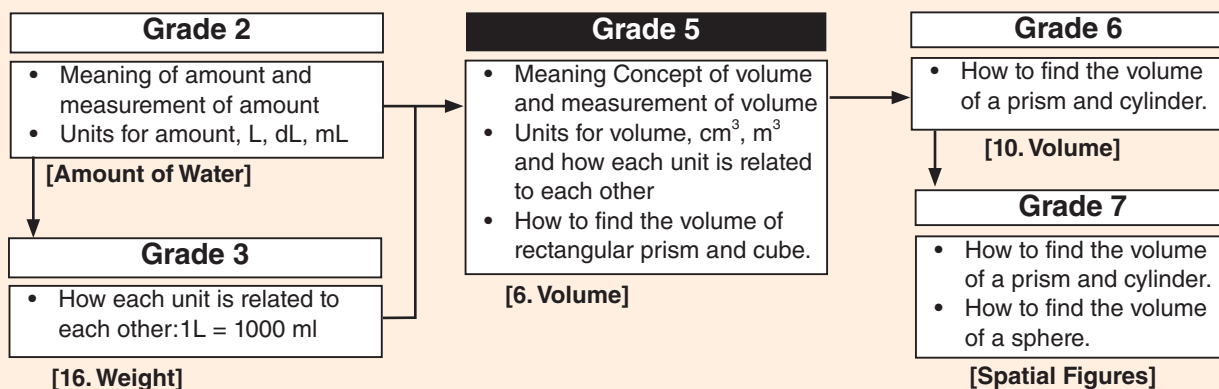

**Sub-unit Objectives**

- To understand how to compare the 3 dimensional shape.
- To understand the meaning of volume and unit  $\text{cm}^3$ .

**Lesson Objective**

- To think about how to compare larger or smaller 3 dimensional shapes.

**Prior Knowledge**

- Draw nets and make rectangular prisms and cubes on square paper

**Preparation**

- Square grid paper (see attachment page) to make box, ruler, scissors, glue and sticky tape
- Three boxes (A), (B) and (C)

**Assessment**

- Think about ways on how to compare the volume of boxes. **F**
- Enjoy comparing the size of boxes using direct comparison. **F**
- Enjoy comparing the volume of boxes. **F S**

**Teacher's Notes**

Direct comparison is comparing two objects through direct observation of size, length, weight, etc...

Arbitrary units - normally it is using any objects that are around to help get approximate results.

**6**

**Volume**

- ▶▶ Let's draw the development of a rectangular prism and a cube on a squared paper below. How can you make the largest box?

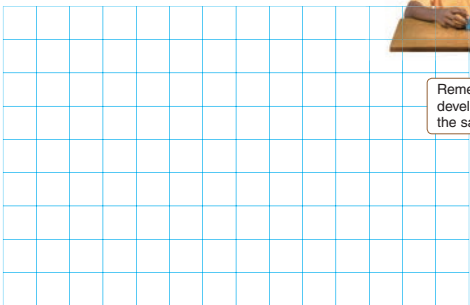

Remember development is the same as net.



- ▶▶ Whose box is the largest amongst the three?

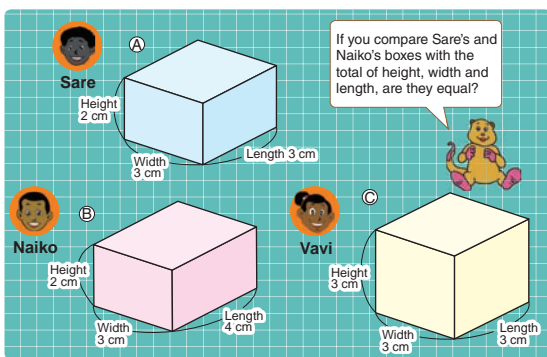

If you compare Sare's and Naiko's boxes with the total of height, width and length, are they equal?

74 = □ × □

**1 Volume**

- 1 Let's compare the sizes of the boxes which the three children prepared.

Compare Sare's and Naiko's boxes.

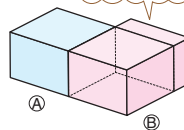

This part will make Naiko's box larger than Sare's.

Compare Sare's and Vavi's boxes.

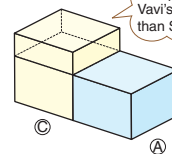

This part will make Vavi's box larger than Sare's.

Compare Naiko's and Vavi's box.

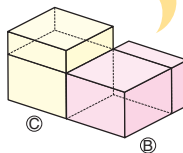

In this way we can't see which is larger.

We used the unit square of  $1 \text{ cm}^2$  for knowing the area.

- 1 Let's think about how to compare the sizes of the boxes.



Let's explore how we can represent the sizes of rectangular prisms and cubes.

□ - □ = 75

## Lesson Flow

### 1 To make the largest box

- T** ▶▶ Let's draw the development (net) of a rectangular prism and a cube on a squared paper below.  
How can you make the largest box?
- S** Draw the net, cut and fold to make the shape of the three boxes for Sare, Naiko and Vavi using square grid of 9 cm × 14 cm.
- TN** Prepare three sample boxes prior to the lesson.
- T** ▶▶ Whose box is the largest amongst the three?
- S** Respond based on their observation.
- T** Introduce the Main Task. (Refer to the BP)

### 2 Compare the sizes of boxes (A), (B) and (C)

- T** ① Let's compare the sizes of the boxes which the three students prepared.
- S** Compare box (A) and box (B) and discuss which is bigger.
- S** Compare box (C) and box (A) and discuss which is bigger.
- S** Compare box (C) and box (B) and discuss which is bigger.

### 3 Think about ways on how to compare the sizes of boxes (B) and (C).

- T** ① Let's think about how to compare sizes of the boxes.
- TN** Using direct comparison, students can see that the side length of box (C) is smaller than box (B).  
However, we cannot compare easily because we cannot see which is larger.  
They look almost the same size so how can we easily compare the sizes of the boxes.
- S** Discuss and share ideas on how to compare box (B) and (C) easily.

### 4 Summary

- T** What have you learned in this lesson?
- S** Present ideas on what they have learned.
- T** Use students' ideas to confirm the important concepts of this lesson.

## Sample Blackboard Plan

**Date:** \_\_\_\_\_ **Chapter:** 6 Volume **Sub-chapter:** 1. Volume **Lesson Number:** 1/2

**MT: Let's compare the sizes of each boxes.**

▶▶ On a 9cm x 14 cm grid paper draw the nets, cut and fold to make the shapes for the boxes.

Sare: Net (A)

**A**  
Sare

**B**  
Naiko

**C**  
Vavi

**MT: Introduce the main task here.**

**① Volume**

① Let's compare the sizes of boxes which three children prepared.

Naiko: Net (B)

This part makes Naiko's box larger than Sare's box..

This part makes Vavi's box larger than Sare's box..

In this way we can't see which is larger.

① Let's think about how to compare sizes of the boxes.

Write down students' ideas about how to compare box B and C.

**Summary**  
Direct comparison can be used to compare the sizes of the boxes.

Lesson Objectives

- To understand the meaning of volume by using 1 cm<sup>3</sup> (1 cm cubic block).
- To understand the unit of 1 cm<sup>3</sup>.

Prior Knowledge

- Draw net and make rectangular prisms and cubes on square paper
- Compare the volume of rectangular prism directly

Preparation

- 1 cm cubic block
- Box (B) and (C) from the previous lesson

Assessment

- Compare the volume of prisms using 1 cm<sup>3</sup> blocks correctly. **F**
- Understand the meaning of volume and the unit of 1 cm<sup>3</sup>. **S**

Teacher's Notes

Different solids can be made from 12 cubes of 1 cm cube however, the volume remains the same.

2 We made the same solids by using 1 cm cubic blocks. Let's compare the number of cubes needed to make Naiko and Vavi's boxes.

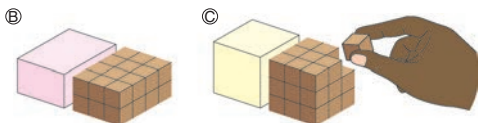

- (B) needs 24 boxes.
- (C) needs 27 boxes.
- (B) needs 3 more boxes.

2 How many 1 cm cubes are needed for the following rectangular prism and cube?

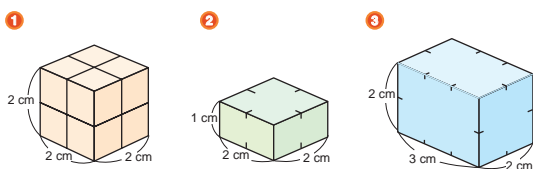

18 1 cm cubes    4 1 cm cubes    12 1 cm cubes

The size of a solid represented by a number of units is called **volume**.

1 cm cube is used as a unit for volume. We represent volume by counting the number of cube units.



The volume of a cube with 1 cm sides is called **1 cubic centimetre** and is written as 1 cm<sup>3</sup>. Cubic centimetre (cm<sup>3</sup>) is a unit of volume.

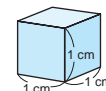

3 Let's find the volume of the following rectangular prism and the cube.

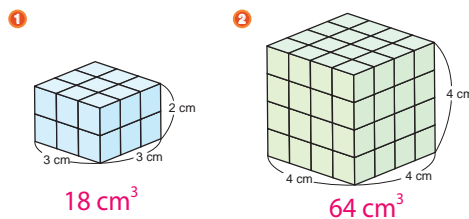

18 cm<sup>3</sup>

64 cm<sup>3</sup>

Same Volume

Use 12 cubes of 1 cm<sup>3</sup> and make different shapes.

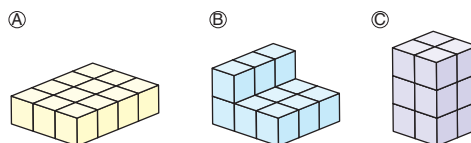

## Lesson Flow

**1** Review the previous lesson.

**2** **2** Using 1 cm<sup>3</sup> block to make the same rectangular prism (B) and cube (C).

**T** Introduce the Main Task. (Refer to the BP)

**T** Using direct comparison we still could not compare box B and box C easily. We need arbitrary unit in order to compare. The arbitrary unit to make comparison easier is 1 cm<sup>3</sup> block.

**S** Compare box B and C using 1 cm<sup>3</sup> blocks and find the number of 1 cm<sup>3</sup> blocks needed for each box and fill in the box .

**3** **2** Understand the meaning of volume.

**T** Ask the students to read the task and observe the solid shapes 1, 2 and 3.

**S** Observe the solid shapes 1, 2 and 3 to find how many 1 cm<sup>3</sup> blocks are needed for the solid shapes respectively.

**S** 1 8 of 1 cm cubic blocks 2 4 of 1 cm<sup>3</sup> blocks and 3 12 of 1 cm<sup>3</sup> blocks.

**4** Important Point

**T/S** Explain the important point in the box .

**5** Find the volume of rectangular prism and cube by using 1 cm<sup>3</sup>.

**S** 3 Read the task and count the number of 1 cubic centimetre as a unit for volume that makes the rectangular prism and cube in 1 and 2.

**S** 1 18 cm<sup>3</sup> and 2 64 cm<sup>3</sup>.

**T** Confirm each volume for 1 and 2 by showing the number of 1 cm<sup>3</sup> that each shape has.

**6** Using 12 cubes, make various solids with same volume.

**TN** Different shapes can be made from 12 cubes of 1 cm<sup>3</sup> however the volume remains the same.

**T** Ask students to make any solids using 12 cubes of 1 cm<sup>3</sup>.

Shapes A, B and C are examples.

**S** Make various shapes.

**T** What happens to the volume when the shape is changed?

**S** Identify that the volume remains the same even though the shape changes.

**7** Summary

**T** What have you learned in this lesson?

**S** Present ideas on what they have learned.

**T** Use students' ideas to confirm the important concepts of this lesson.

## Sample Blackboard Plan

**Date:** \_\_\_\_\_ **Chapter:** 6 Volume. **Sub- chapter:** Volume **Lesson Number:** 2/2

**MT:** Understanding the size of the solid shapes.

**MT:** Introduce the main task here.

Using 1cm cubic block as the arbitrary unit to compare.

2 Let's compare the number of cubic blocks needed to make Naiko's and Vivi's box.

1

2cm 2cm 2cm

8 one cm cubic blocks.

2

1cm 1cm 1cm

4 one cm cubic blocks.

3

3cm 2cm 2cm

12 one cm cubic blocks.

The size of a solid represented by a number of units is called **volume**.

The volume of a cube with 1 cm sides (edges) is called 1 cubic centimeter and is written as 1 cm<sup>3</sup>. cm<sup>3</sup> is a unit of volume.

1

3cm 2cm 3cm

18 cm<sup>3</sup>

2

4cm 4cm 4cm

64 cm<sup>3</sup>

**Same Volume**

Display different shapes made by students using 12 cubes of 1 cm<sup>3</sup>.

**Summary**

The volume is the same even the shape is changed.

# Unit 6

## Unit: Volume Sub-unit 2: Formula for Volume Lesson 1 of 2

Textbook Page :  
078 and 079  
Actual Lesson 051

### Sub-unit Objectives

- To understand the formula for finding the volume of rectangular prisms and cubes.
- To understand that there are various shapes which have the same volume.

### Lesson Objective

- To understand the formula for finding the volume of rectangular prisms.

### Prior Knowledge

- How to show the volume
- Unit of volume

### Preparation

- Chart diagram for 1 and 2

### Assessment

- Think about how to find the volume of rectangular prism. **F**
- Understand the formula for calculating the volume of a rectangular prism. **S**

### Teacher's Notes

In order for the students to understand the formula to calculate the volume of rectangular prisms, firstly, use the diagram to explain using the cubes.

Later they will realise the formula in the important point.

### 2 Formula for Volumes

- 1 Let's think about how to find the volume of the rectangular prism on the right.

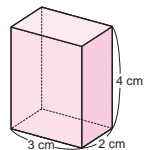

- 1 How many 1 cm<sup>3</sup> cubes are on the bottom layer?

$$2 \times 3 = 6 \quad \text{Answer: 6 1cm cubes}$$

- 2 How many layers are there?

4 layers

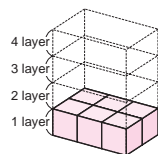

- 3 How many 1 cm<sup>3</sup> cubes are there and what is its volume?

$$3 \times 2 \times 4 = 24$$

Number of length	Number of width	Number of height	Total number
3	2	4	24

The number of cubes used in length is equal to length, the number of cubes used in width is equal to width and the number of cubes used in height is equal to height respectively.

$$3 \times 2 \times 4 = 24 \text{ (cm}^3\text{)}$$

Length	Width	Height	Volume
3	2	4	24

What do we need to know in order to calculate volume?



The volume of a rectangular prism is expressed in the following formula using length, width and height.

$$\text{Volume of rectangular prism} = \text{length} \times \text{width} \times \text{height}$$

- 2 Let's find the volume of the following prisms below.

1

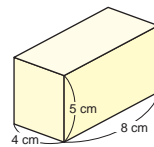

$$8 \times 4 \times 5 = 160$$

Answer: 160 cm<sup>3</sup>

2

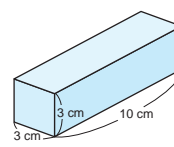

$$10 \times 3 \times 3 = 90$$

Answer: 90 cm<sup>3</sup>

3

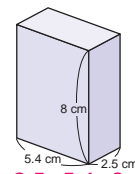

$$2.5 \times 5.4 \times 8 = 108$$

Answer: 108 cm<sup>3</sup>

- 3 Let's find the volume of this cube.

1

- How many 1 cm<sup>3</sup> cubes are there in this cube?

- 2 What is the volume?

$$3 \times 3 \times 3 = 27$$

Answer: 27 1cm cubes



Volume is 27 cm<sup>3</sup>

Since the size of length, width and height of cube are equal, its formula is the following:

$$\text{Volume of cube} = \text{side} \times \text{side} \times \text{side}$$

## Lesson Flow

**1** Review the previous lesson.

**2** **1** Think about how to find the volume of rectangular prism.

**T** Introduce the Main Task. (Refer to the Blackboard Plan)

**S** Read the task, observe the rectangular prism and think about how to find its volume.

**T** In our previous lesson we found how many  $1 \text{ cm}^3$  as a unit of volume that made up a rectangular prism or cube by counting the number of  $1 \text{ cm}^3$ .

**T** Let's observe the rectangular prism and find how many  $1 \text{ cm}^3$  are on the bottom layer?

**S** **1** By observing the bottom or 1st layer of the rectangular prism.  $3 \times 2 = 6$ .  
Answer: 6 of one cubic centimetre cubes.

**S** **2** By observing the rectangular prism and identify that there are 4 layers.

**T** To answer **3** and find the volume what do we need to know in order to calculate the volume?

**S** We need to know the number of length  $\times$  number of width  $\times$  number of layers that is the height = total number.  $3 \times 2 \times 4 = 24$ .

**S** Read and understand "the number of cubes used in length is equal to the length, the number of cubes used in width is equal to width and the number of cubes used in height is equal to height respectively.  $3 \text{ (length)} \times 2 \text{ (width)} \times 4 \text{ (height)} = 24 \text{ cm}^3 \text{ (volume)}$ ".

**3** Important Point

**T/S** Explain the important point in the box  .

**4** **2** Apply the formula to find the volume.

**S** Calculate **1**, **2** and **3** by applying the formula for volume.

**T** Confirm students' answers.

**5** Summary

**T** What have you learned in this lesson?

**S** Present ideas on what they have learned.

**T** Use students' ideas to confirm the important concepts of this lesson.

### Sample Blackboard Plan

Date:
Chapter: 6 Volume.
Sub-chapter: 2. Formula for Volume.
Lesson Number: 1/2

**MT: Let's find the volume of a rectangular prism.**

**MT:** Introduce the main task here.

**2** **Formula for Volumes**

**1** Let's think about how to find the volume of this rectangular prism.

**1** How many  $1 \text{ cm}^3$  cubes are on the bottom layer?  
 $2 \times 3 = 6$     Answer: 6  $1 \text{ cm}^3$  cubes.

**2** How many layers are there?    Answer: 4 layers.

**3** How many  $1 \text{ cm}^3$  cubes are there? What is the volume?

$3 \times 2 \times 4 = 24$

3	$\times$	2	$\times$	4	=	24
Number of length		Number of width		Number of height		Total number

$3 \times 2 \times 4 = 24 \text{ (cm}^3\text{)}$

3	$\times$	2	$\times$	4	=	24	(cm <sup>3</sup> )
Length		Width		Height		Volume	

The volume of rectangular prism is expressed in the following formula, using length, width and height.

**Volume of rectangular prism = length  $\times$  width  $\times$  height.**

**2** Let's find the volume of the prisms by using the formula.

**1**  $V = \text{Length} \times \text{width} \times \text{height}$   
 $= 8 \times 4 \times 5$   
 $= 160$     Answer: 160  $\text{cm}^3$

**2**  $V = \text{Length} \times \text{width} \times \text{height}$   
 $= 10 \times 3 \times 3$   
 $= 90$     Answer: 90  $\text{cm}^3$

**3**  $V = \text{Length} \times \text{width} \times \text{height}$   
 $= 5.4 \times 2.5 \times 8$   
 $= 108$     Answer: 108  $\text{cm}^3$

**Summary**  
The volume of a rectangular prism can be calculated using this formula:  
**Volume of rectangular prism = length  $\times$  width  $\times$  height**

# Unit 6

## Unit: Volume Sub-unit 2: Formula for Volume Lesson 2 of 2

Textbook Page :  
079 and 080  
Actual Lesson 052

### Lesson Objective

- To understand the formula for finding the volume of a cube.

### Prior Knowledge

- Formula for finding the volume of rectangular prism

### Preparation

- Diagrams for 3, Exercise and 4
- Square papers, scissors, sticky tape, glue and rulers

### Assessment

- Think about how to find the formula for finding the volume of a cubes. **F**
- Find the volume of rectangular prism and cube using the formula. **S**
- Solve the exercises correctly. **S**

### Teacher's Notes

Use arbitrary unit (1 cm<sup>3</sup>) to find the volume of the cube in 3.

Later the students can use the formula given in the important point.



The volume of a rectangular prism is expressed in the following formula using length, width and height.

$$\text{Volume of rectangular prism} = \text{length} \times \text{width} \times \text{height}$$

2 Let's find the volume of the following prisms below.

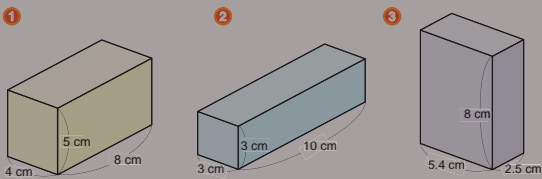

3 Let's find the volume of this cube.

$$3 \times 3 \times 3 = 27$$

Answer: 27 1cm cubes

1 How many 1 cm<sup>3</sup> cubes are there in this cube?

2 What is the volume?  
Volume is 27 cm<sup>3</sup>

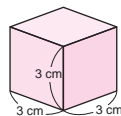

Since the size of length, width and height of cube are equal, its formula is the following:

$$\text{Volume of cube} = \text{side} \times \text{side} \times \text{side}$$

### Exercise

1 Let's find the volumes of the rectangular prism and the cube below.

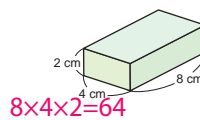

$$8 \times 4 \times 2 = 64$$

Answer: 64 cm<sup>3</sup>

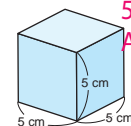

$$5 \times 5 \times 5 = 125$$

Answer: 125 cm<sup>3</sup>

2 Let's find the volumes of rectangular prisms and cubes from your surroundings.

4 Fold the development below and find the volume.

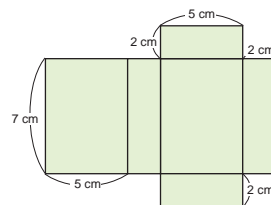

$$7 \times 5 \times 2 = 70$$

Answer: 70 cm<sup>3</sup>

### Let's Make a Box of 200 cm<sup>3</sup>

Make several boxes which have a volume of 200 cm<sup>3</sup>.

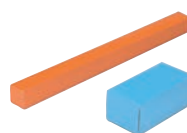

What is the length, width and height?





## Lesson Flow

**1** Review the previous lesson.

**2** **3** Finding the volume of a cube

**T** Introduce the Main Task. (Refer to the BP)

**T** **1** How many 1 cm<sup>3</sup> are there in the cube given?

**S**  $3 \times 3 \times 3 = 27$ .

There are 27 of 1 cm cubes.

**T** **2** What is the volume?

**S** Volume is 27 cm<sup>3</sup>.

**3** Important Point

**T/S** Explain the important point in the box .

**4** Complete the Exercise

**T** Guide students on how to find the volume of rectangular prism.

**S** Explain **1** and **2** by applying the previous knowledge.  
(Formula for finding rectangular prism and cube)

**T** Get the students to find the volumes of rectangular prisms and cubes from their surroundings.

**S** Find the volume of rectangular prisms and cubes from the surroundings.

**5** Apply the formula for finding the volume.

**T** **4** Ask the students to fold the development of the net given and find the volume.

**TN** The position and the measurements can be switched however the volume remains the same.

**S** Fold the development and switch the position and measurements.

Find the length, the width and the height to calculate the volume. The volume will be 70 cm<sup>3</sup>.

**6** Let's make a box of 200 cm<sup>3</sup>.

**S** Find the length, width and height to make the box of 200 cm<sup>3</sup>.

**S** Share their ideas on net development and display their boxes.

**7** Summary

**T** What have you learned in this lesson?

**S** Present ideas on what they have learned.

**T** Use students' ideas to confirm the important concepts of this lesson.

## Sample Blackboard Plan

Date:
Chapter: 6 Volume
Sub-chapter: 2, Formula for Volume.
Lesson Number: 2/2

**MT: Find the volume of a cube.**

**MT:** Introduce the main task here.

**3** Let's find the volume of this cube.



**1** How many 1cm cubes are there in this cube?  
 $3 \times 3 \times 3 = 27$   
Answer: 27 1cm cubes.

**2** What is the volume?  
Answer: 27 cm<sup>3</sup>.

Since the size of the length, width and height of the cube are equal, its formula is the following.

**Volume of cube = side x side x side**

**Exercise.**

**1** Let's find the volumes of rectangular prism and cube below.

**1**

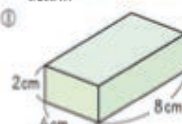

$V = \text{Length} \times \text{width} \times \text{height}$   
 $= 8 \times 4 \times 2$   
 $= 64$   
Answer: 64 cm<sup>3</sup>

**2**

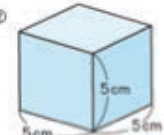

$V = \text{side} \times \text{side} \times \text{side}$   
 $= 5 \times 5 \times 5$   
 $= 125$   
Answer: 125 cm<sup>3</sup>

**2** Let's find the volumes of rectangular prisms and cubes from your surroundings.

**4** Fold the development below and find the volume..

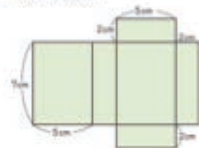

$V = \text{Length} \times \text{width} \times \text{height}$   
 $= 7 \times 5 \times 2$   
 $= 70$   
Answer: 70 cm<sup>3</sup>

**Summary.**  
The volume of a cube can be calculated using this formula:  
**Volume of cube = side x side x side**

**Let's Make a Box of 200 cm<sup>3</sup>**

Make several boxes which have a volume of 200 cm<sup>3</sup>.



What's the length, width and height?

**Sub-unit Objectives**

- To understand the relationship between  $\text{cm}^3$  and  $\text{m}^3$ .
- To understand the relationship between capacity and volume.
- To understand how to find the volume and capacity of combined shapes.

**Lesson Objectives**

- To understand the unit  $\text{m}^3$ .
- To understand the relationship between cubic centimetre and metre.
- To get the sense of large volume.

**Prior Knowledge**

- Drawing nets of rectangular prisms and cubes in cm
- Unit of volume
- Formula for finding volume of rectangular prism and cube

**Preparation**

- Diagrams for 1 and 2
- Chart for the Important point

**Assessment**

- Think about the relationship between  $1 \text{ m}^3$  and  $1 \text{ cm}^3$ . **F**
- Understand  $1 \text{ m}^3$  as a unit of volume. **S**
- Find the volume of shapes. **S**

**Teacher's Notes**

Use the conversion of  $1 \text{ m} = 100 \text{ cm}$  to help students to identify the length, width and height in cm.

**3 Large Volumes**

1 Let's think about how to express the volume of a large rectangular prism such as this one.

1 How many  $1 \text{ m}$  cubes are in this prism?  
 $3 \times 2 \times 2 = 12$

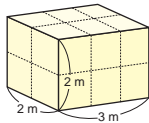

**Answer: 12 of 1 cubic metre**

The volume of a cube with  $1 \text{ m}$  sides is called **1 cubic metre** and expressed as  $1 \text{ m}^3$ .

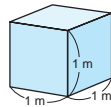

2 What is the volume of the prism in  $1 \text{ m}^3$ ?  
**Answer:  $12 \text{ m}^3$**

2 Let's find how many  $\text{cm}^3$  equals to  $\text{m}^3$ .

1 How many  $1 \text{ cm}^3$  cubes will line up for the width and the length of  $1 \text{ m}^2$  base?

2 How many layers of  $1 \text{ cm}^3$  are there?

3 What is the total of  $1 \text{ cm}^3$  cubes and the volume in cubic centimetre?

**$1000\ 000 \text{ cm}^3$**

$100 \times 100 \times 100 = 1000\ 000 \text{ (cm}^3\text{)}$

Length Width Height Volume

**$1 \text{ m}^3 = 1\ 000\ 000 \text{ cm}^3$**

1 m is equal to how many cm?



## Lesson Flow

**1** Review the previous lesson.

**2** **1** Think about how to express the volume of a large rectangular prism.

**TN** The volume can be expressed using the formula for rectangular prism focused on the larger volume from cubic centimetre (smaller volume) to cubic metre (larger volume).

**S** Read the task and observe the large rectangular prism and think about how to express its volume.

**S** Write the answer for **1**.  $3 \times 2 \times 2 = 12$ .  
Answer: 12 of  $1 \text{ m}^3$ .

**3** Important Point

**T/S** Explain the important point in the box  .

**4** **2** Finding the volume of prism in  $\text{m}^3$ .

**S** The volume of the prism in  $\text{m}^3$  is  $12 \text{ m}^3$ .

**T** Introduce the Main Task. (Refer to the BP)

**5** **2** Find how many cubic centimetres is equal to 1 cubic metre.

**T** Ask the students to observe the magnified diagram representation and think about how many cubic centimetres will make up 1 cubic metre.

**TN** Assist the students to understand that cubic centimetre is smaller volume that will make the larger volume cubic metre.

**S** Observe the magnified diagram representation and discuss to make sense of larger volume.

**S** Observe the magnified diagram representation and answer **1** as 100 of  $1 \text{ cm}^3$ .

**TN** For **1** explain the relationship  $1 \text{ m} = 100 \text{ cm}$  therefore for the length and width the measurement is  $1 \text{ m}$  respectively then it is  $100 \text{ cm}$  for the length and  $100 \text{ cm}$  for the width.

**S** Answer **2** as 100 layers.

**S** Write the answer to **3** by applying the formula for volume to calculate and fill in the box  .

**6** Summary

**T** Explain the relationship of  $1 \text{ m}^3$  and  $\text{cm}^3$  as prepared in the blackboard plan.

**S** Understand  $1 \text{ m}^3 = 1\,000\,000 \text{ cm}^3$  and realise that 1 cubic metre is very large compared to  $1 \text{ cm}^3$ .

They feel the sense of larger volume.

## Sample Blackboard Plan

Date:
Chapter: 6 Volume
Sub-chapter: 3. Large Volumes
Lesson Number: 1/5

**MT: Understanding the relationship of  $1 \text{ cm}^3$  and  $1 \text{ m}^3$ .**

**3 Large Volumes**

**1** Let's think about how to express the volume of a large rectangular prism such as this one..



**1** How many  $1 \text{ m}$  cubes are in this prism?  
 $3 \times 2 \times 2 = 12$  Answer: 12  $1 \text{ m}$  cubes.

The volume of a cube with  $1 \text{ m}$  edges is called 1 **cubic meter** and expressed as  $1 \text{ m}^3$ .



**2** What is the volume of the prism in  $1 \text{ m}^3$ ?  $12 \text{ m}^3$

**MT: Introduce the main task here.**

**2** Let's find how many  $\text{cm}^3$  equals to  $1 \text{ m}^3$ .



**1** How many  $1 \text{ cm}^3$  cubes will line up for width and length of  $1 \text{ m}^2$  base?  
100 of  $1 \text{ cm}^3$  cubes.

**2** How many layers are there?  
100 layers.

**3** What is the total of  $1 \text{ cm}^3$  cubes and the volume in cubic centimeter?  
Volume =  $L \times W \times H$   
 $= 100 \times 100 \times 100$   
 $= 1\,000\,000$  Answer:  $1\,000\,000 \text{ cm}^3$

$1 \text{ m}^3 = 1\,000\,000 \text{ cm}^3$

Relationship of  $1 \text{ m}^3$  and  $\text{cm}^3$ .



$1 \text{ m} = 100 \text{ cm}$

$1 \text{ m}^3 = 1 \text{ m} \times 1 \text{ m} \times 1 \text{ m}$   
 $= 100 \text{ cm} \times 100 \text{ cm} \times 100 \text{ cm}$   
 $= 1\,000\,000 \text{ cm}^3$

$1 \text{ m}^3 = 1\,000\,000 \text{ cm}^3$

**Summary**  
We compare very large volumes using these formula as:  
 $1 \text{ m}^3 = 1\,000\,000 \text{ cm}^3$

**Lesson Objective**

- Find the volume of prism of which the sides are expressed in both metres (m) and centimetres (cm).

**Prior Knowledge**

- Unit of m<sup>3</sup>
- Relationship between cubic metre and cubic centimetre

**Preparation**

- Diagrams for **3** and Exercise

**Assessment**

- Think about how to find the volume of prisms with sides expressed in both metres (m) and centimetres (cm). **F**
- Solve the exercises correctly. **S**

**Teacher's Notes**

In task **3**, remember to do conversion for all given measurements to a common unit before calculating.

**3** Let's find the volume of the rectangular prism on the right.

**1** Think about how to calculate.

**2** What is its volume in m<sup>3</sup> and in cm<sup>3</sup>?

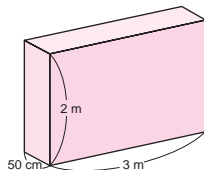

$3 \times 0.5 \times 2 = 3$   
Answer: 3 m<sup>3</sup>

$3 \times 1000\ 000 = 3\ 000\ 000\ \text{cm}^3$

**Exercise**

**1** What is the volume of this rectangular prism?

$2 \times 0.2 \times 0.2 = 0.08$

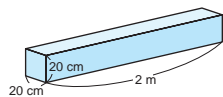

**2** Find the volume of this rectangular prism both in m<sup>3</sup> and cm<sup>3</sup>.

$0.08 \times 1000\ 000 = 80\ 000$  Answer: 80 000 cm<sup>3</sup>

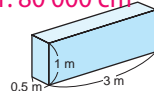

$3 \times 0.5 \times 1 = 1.5$  Answer: 1.5 m<sup>3</sup>

$1.5 \times 1000\ 1000 = 1500\ 000$  Answer: 1 500 000 cm<sup>3</sup>

**The Volume of 1 m<sup>3</sup> Cube**

How many people can get inside this 1 m<sup>3</sup> cube?



## Lesson Flow

**1** Review the previous lesson.

**2** **3** Find the volume of a rectangular prism of which sides are expressed in metre and centimetre.

**T** Introduce the Main Task. (Refer to the BP)

**T** **1** Unit of length and width are different. How can we find the volume?

**S** Recognise that they cannot multiply directly because of the different units of sides of the prism.

**S** Change m to cm or vice versa to use the same unit for length, width and height.

**T** How many metres is 50 cm?

**S** Convert 50 cm to 0.5 m by dividing 50 by 100.

**T** **2** What is its volume in  $m^3$  and  $cm^3$ ?

**S** Convert 2 metres and 3 metres to centimetres so that 2 m is equal to 200 cm and 3 m is equal to 300 cm.

**S** Calculate:  $300 \times 50 \times 200 = 3\,000\,000\,cm^3$

**S** Convert 50 cm to metres so that 50 cm is 0.5 m and calculate  $0.5 \times 3 \times 2$   
Answer:  $3\,m^3$

**TN** Students can also convert  $3\,000\,000\,cm$  to  $3\,m^3$  by dividing with 1 000 000 to get  $3\,m^3$ .

**4** Complete the Exercise.

**S** **1** Calculate the volume of the rectangular prism by using either  $m^3$  or  $cm^3$ .

**S** **2** Calculate the volume of the rectangular prism using both  $cm^3$  and  $m^3$ .

**T** Confirm students' answers.

**5** The sense of volume of one cubic metre ( $1m^3$ ).

**T** How many people can get inside this  $1\,m^3$  cube?

**TN** This activity improves students sense of the smaller volume compared to the larger volume.

**6** Summary

**T** What have you learned in this lesson?

**S** Present ideas on what they have learned.

**T** Use students' ideas to confirm the important concepts of this lesson.

## Sample Blackboard Plan

**Date:** \_\_\_\_\_ **Chapter:** 6 Volume **Sub-chapter:** 2. Formula for Volume. **Lesson Number:** 2/5

**MT: Finding the volume of rectangular prisms with different units.**

**3** Let's find the volume of this rectangular prism.

**MT: Introduce the main task here.**

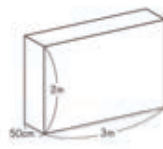

**1** Think about how to calculate.

- Calculation cannot be done because of different units used.
- Change the different units to same unit.
- Change meters to centimeters or vice versa for calculation.
- Convert 50 cm to 0.5 m by dividing 50 by 100

**2** What is its volume?

**Answer in  $m^3$ .**  
 Volume =  $L \times W \times H$   
 $= 3 \times 0.5 \times 2$   
 $= 3$   
**Answer:  $3\,m^3$**

**Answer in  $cm^3$ .**  
 Volume =  $L \times W \times H$   
 $= 300 \times 50 \times 200$   
 $= 3\,000\,000$   
**Answer:  $3\,000\,000\,cm^3$**

**Or using the prior knowledge.**

$1\,m^3 = 1\,000\,000\,cm^3$   
 $3\,m^3 = 3 \times 1\,000\,000$   
 $= 3\,000\,000$   
**Answer:  $3\,000\,000\,cm^3$**

**Exercise**

**1**

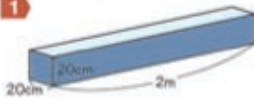

What is its volume of this rectangular prism?

Volume =  $L \times W \times H$   
 $= 2 \times 0.2 \times 0.2$   
 $= 0.08$   
**Answer:  $0.08\,m^3$**

**Answer in  $cm^3$**   
 $0.08 \times 1\,000\,000 = 80\,000$   
**Answer:  $80\,000\,cm^3$**

**2** Find the volume of this rectangular prism both in  $m^3$  and  $cm^3$ .

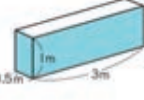

**Answer in  $m^3$ .**  
 Volume =  $L \times W \times H$   
 $= 3 \times 0.5 \times 1$   
 $= 1.5$   
**Answer:  $1.5\,m^3$**

**Answer in  $cm^3$ .**  
 Volume =  $L \times W \times H$   
 $= 300 \times 50 \times 100$   
 $= 1\,500\,000$   
**Answer:  $1\,500\,000\,m^3$**

**Or using the prior knowledge.**

$1\,m^3 = 1\,000\,000\,cm^3$   
 $1.5\,m^3 = 1.5 \times 1\,000\,000$   
 $= 1\,500\,000$   
**Answer:  $1\,500\,000\,cm^3$**

**Summary**  
 When calculating volume with different units, change to common unit before calculating.

**Lesson Objective**

- To understand the relationship of centimetres ( $\text{cm}^3$ ), cubic metres ( $\text{m}^3$ ), millilitres (mL) and litres (L).

**Prior Knowledge**

- Unit of centimetres ( $\text{cm}^3$ ) and cubic metres ( $\text{m}^3$ )
- How to find the volume which has different units of measurement

**Preparation**

- Diagram for **4**

**Assessment**

- Enjoy finding the relationship between the amount of water and the volume. **F S**

**Teacher's Notes**

Be careful in explaining the diagrams in task **4** because the colour of the small box must be clearly identified.

Make sure that the magnified box is clearly identified and explained well to help students visualise the relationship from a smaller unit of volume to a larger unit of a volume.

**4** Let's check the relationship between the amount of water and the volume.

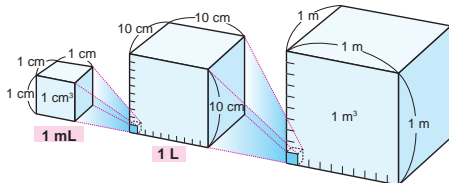

**1** 1 L equals 1000 mL. How many  $\text{cm}^3$  is 1 L?  $1 \text{ mL} = \boxed{1} \text{ cm}^3$

**2** Find the volume in  $\text{cm}^3$  of the water which would fill a 1 L container.  $1 \text{ L} = \boxed{1000} \text{ cm}^3$

**3** How many L of water will fill a  $1 \text{ m}^3$  tank?  $1 \text{ m}^3 = \boxed{1\,000\,000} \text{ cm}^3$   
 $= \boxed{1\,000} \text{ L}$



The units for the amount of water are expressed by L, dL and mL.

$1000 \text{ L} = 1 \text{ m}^3$     $1 \text{ dL} = 100 \text{ cm}^3$     $1 \text{ mL} = 1 \text{ cm}^3$

**5** Let's think about how to find the volume of the solid on the right.

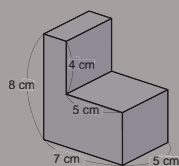

## Lesson Flow

**1** Review the previous lesson.

**2** **4** **1** Understand the relationship of mL, L, cm<sup>3</sup> and m<sup>3</sup>.

**T** Introduce the Main Task. (Refer to the Blackboard Plan)

**S** Read the task and observe the diagram in order to make meaning of the relationship between the amount of water and the volume.

**T** Explain the relationship of mL, L, cm<sup>3</sup> and m<sup>3</sup> as in the blackboard plan.

**S** Understand and make meaning of the relationship of mL, L, cm<sup>3</sup> and m<sup>3</sup> explained by the teacher.

**TN** For **1**, **2** and **3**, ask students to make reference to the relationship of mL, L, cm<sup>3</sup> and m<sup>3</sup> to confirm their answers.

**T** **1** Refer to the explanation of the relationship of mL, L, cm<sup>3</sup> and m<sup>3</sup> and think about how many cm<sup>3</sup> is equal to 1 mL.

**S** Write the answer to **1** by filling in the box . (1)

**3** Understand the relationship between the 1 Litre (L) and cubic centimetres (cm<sup>3</sup>)

**S** Write the answer to **2** by filling in the box . (1 000)

**4** Understand the relationship between the Litre (L) and 1 cubic metre (1 m<sup>3</sup>).

**S** Write the answer to **3** by filling in the box . (1 000 000), (1 000)

**5** Important Point

**T/S** Explain the important point in the box .

**6** Summary

**T** What have you learned in this lesson?

**S** Present ideas on what they have learned.

**T** Use students' ideas to confirm the important concepts of this lesson.

## Sample Blackboard Plan

**Date:** \_\_\_\_\_ **Chapter:** 6 Volume **Sub-chapter:** 2. Formula for Volume. **Lesson Number:** 3/5

**MT: Understanding the relationship between mL, L, cm<sup>3</sup> and m<sup>3</sup>.**

**4** Let's check the relationship between the amount of water and the volume.

**MT:** Introduce the main task here.

**Relationship between mL, L, cm<sup>3</sup> and m<sup>3</sup>.**

1 mL = 1 cm<sup>3</sup>

1L = 1 000 cm<sup>3</sup>  
 1L = 1 000 mL  
 1 000 mL = 1 000 cm<sup>3</sup>

1 000 L = 1 m<sup>3</sup>  
 1 000 000 cm<sup>3</sup> = 1 m<sup>3</sup>

**1** 1 L equals 1 000 mL. How many cm<sup>3</sup> is 1 mL?

1 mL =  cm<sup>3</sup>

**2** Find the volume, in cm<sup>3</sup>, of water which would fill 1L container.

1 L =  cm<sup>3</sup>

**3** How many L of water will fill 1m<sup>3</sup> tank?

1 m<sup>3</sup> =  cm<sup>3</sup>  
=  L

The units for the amount of water are expressed by L, dL and mL.

**1 000 L = 1 m<sup>3</sup>    1 mL = 1 cm<sup>3</sup>**

**Summary**  
We can see the relationship between mL, L, cm<sup>3</sup> and m<sup>3</sup>.  
 1 mL = 1 cm<sup>3</sup>  
 1 L = 1 000 cm<sup>3</sup>  
 1 m<sup>3</sup> = 1 000 000 cm<sup>3</sup> or 1 000 L.

**Lesson Objective**

- To think about how to find the volume of combined solid shapes.

**Prior Knowledge**

- How to find the volume (Formula for finding volume)

**Preparation**

- Diagrams for **5** and **6**
- Chart of student ideas and exercises

**Assessment**

- Think about how to find the volume of combined solid shapes. **S**
- Find the volume of combined solid shapes. **F**

**Teacher's Notes**

Guide students to solve task **5** by themselves because that is where they will think of ways on how to find the volume of combined solid shapes.

**4** Let's check the relationship between the amount of water and the volume.

**1** 1 L equals 1000 mL. 1 mL =  cm³  
How many cm³ is 1 L?

**2** Find the volume in cm³ of the water which would fill a 1 L container. 1 L =  cm³

**3** How many L of water will fill a 1 m³ tank? 1 m³ =  cm³  
=  L

The units for the amount of water are expressed by L, dL and mL.

**1000 L = 1 m³   1 dL = 100 cm³   1 mL = 1 cm³**

**5** Let's think about how to find the volume of the solid on the right.

-  = 83

**Gawi's Idea**

$5 \times 2 \times 8 + 5 \times 5 \times 4 = 180 \text{ cm}^3$

**1** Write down expressions and answers by using their ideas.

**2** Discuss with your friends about other ideas.

**Ambai's Idea**

$5 \times (7 + 2) \times 8 \div 2 = 180 \text{ cm}^3$

**Exercise**

Let's find the volume of these solids below.  $4 \times 10 \times 4 - 3 \times 3 \times 3 = 133$   
**Answer: 133 cm³**

**1**

**2**

$30 \times 10 \times 30 + 30 \times 10 \times 20 + 30 \times 10 \times 40 = 27\,000 \text{ cm}^3$

**6** We made an elephant by using a cubic and rectangular prism clay below. Find the volume of the elephant.

$2 \times 2 \times 5 + 6 \times 6 \times 6 = 236$  **Answer: 236 cm³**



## Lesson Flow

**1** Review the previous lesson.

**2** **5** Thinking about how to find the volume of a combined shape.

- T** Introduce the Main Task. (Refer to the BP)
- T** Ask the students to observe the combined solid shape and think about how to calculate its volume.
- S** Observe the combined solid shape and think about how to calculate its volume.
- TN** Give time for discussion and allow students to express their ideas.  
Write their ideas on the blackboard.

**3** Understanding Mero's and Ambai's Ideas

- T** Explain the two ideas.  
Mero's Idea:  
The combined solid shape is divided into 2 solid shapes to calculate their areas separately. Then add up the two areas to find the total area.  
Ambai's Idea:  
The shape is combined with the other same half of the shape to make a complete rectangular prism then the area is calculated and divided by 2 to get the final area.

**4** **1** Write down expressions and answers using the two ideas.

- S** Use explanations done by the teacher on the two ideas and write the expressions and find the volume of the combined solid shape.
- S** **2** Discuss with friends about other ideas and present to the class.
- T** Confirm students' ideas presented.

**5** Complete the Exercise

- S** Calculate the volume of the solid shapes in **1** and **2**.
- T** Confirm students' answers.

**6** **6** Calculate the volume of an elephant.

- S** Observe the diagram and calculate the volume of the elephant by finding the area of the two solid figure when combined.
- TN** When the two solids figures are combined they make up the volume of the elephant (solid A + solid B = the volume of the elephant.).  
Even the shape changes the volume remains the same.

**7** Summary

- T** What have you learned in this lesson?
- S** Present ideas on what they have learned.
- T** Use students' ideas to confirm the important concepts of this lesson.

## Sample Blackboard Plan

Date: \_\_\_\_\_ Chapter: 6 Volume Sub-chapter: 2. Formula for Volume. Lesson Number: 4/5

MT: How to find the volume of a combined shapes.

**5** Let's think about how to find the volume of such a solid shape.

MT: Introduce the main task here.

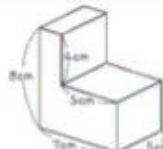

Students' Ideas.

**1 - 2** Write down expressions and answers by using their ideas.

GAWI'S IDEA.

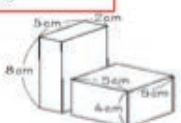

- The combined shape is divided into 2 shapes.
- Calculate its area separately and finally add up the total area for each shape.

$$= (5 \times 2 \times 8) + (5 \times 5 \times 4)$$

$$= 80 + 100 \text{ m}^3$$

$$= 180 \text{ Answer: } 180 \text{ cm}^3$$

AMBAI'S IDEA.

- The shape is combined with the other same half of the shape to make a complete rectangular prism, the area is then calculated and divided by 2.

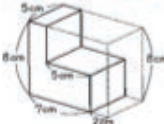

$$= 9 \times 8 \times 5$$

$$= 360/2$$

$$= 180 \text{ Answer } 180 \text{ cm}^3$$

Exercise

**1**

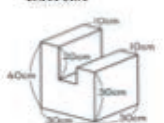

$$= 30 \times 10 \times 30 + 30 \times 10 \times 20$$

$$= 27000 + 6000$$

$$= 33000$$

Answer: 33000 cm<sup>3</sup>

**2**

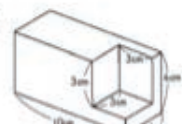

$$= 4 \times 10 \times 4 - 3 \times 3 \times 3$$

$$= 160 - 27$$

$$= 133$$

Answer: 133 cm<sup>3</sup>

**6** Find the volume of the elephant.

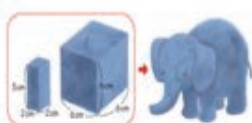

$$= 2 \times 2 \times 5 + 6 \times 6 \times 6$$

$$= 20 + 216$$

$$= 236$$

Answer: 236 cm<sup>3</sup>

**Summary**  
When calculating a combined shape:

1. Calculate its areas separately and finally add up the total area for each shape.
2. Even the combined solid changes, the volume remains the same.

**Lesson Objective**

- To understand how the volume of uneven shapes or irregular shapes such as rocks can be calculated by putting the objects in water.

**Prior Knowledge**

- To think about how to find the volume of combined solid shapes

**Preparation**

- Rocks or stones, yam, sweet potato, water, ruler and 1 transparent container

**Assessment**

- Investigate the volume of uneven or irregular shapes using containers to measure the volume easily. **F**
- Think about how to find the volume of uneven or irregular shapes using containers. **S**

**Teacher's Notes**

The container can be of any size, however, the height of the water in the container must be even.

**Volumes of Various Shapes**

Physical objects have volumes. How can we find the volumes of other objects that are not cubes or rectangular prisms? For example, an uneven shape such as a rock can be calculated by putting it in the water.

- 7** When you sink an object in the water, the level of water will be increase by the volume of the object.

Let's find the volume of the rock below.

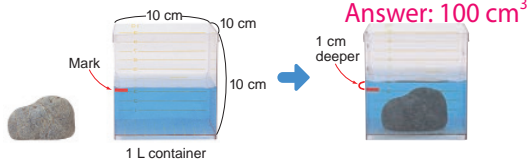

- 8** Let's measure the volume of various objects.

Let's think about the ways of using a container to measure the volume easily.



Before the measurement estimate the volume!



## Lesson Flow

**1** Review the previous lesson.

**2** **7** Think about how to find the volume of shapes that are not cubes or rectangular prisms.

- T** Introduce the Main Task. (Refer to the Blackboard Plan)
- T** Without opening the textbook show a rock or stone to the students and ask them on how to find its volume.
- S** Discuss and share ideas on how they can measure the volume of the stone or rock.
- S** Turn to page 85 of the textbook and read the paragraph on Volumes of Various Shapes.
- S** Estimate the volume of the rock before submerging it into the water.
- T** Explain the task and how to find the volume of the rock when submerged in the water.
  1. Take note of the water level before submerging the object into the water and record it.
  2. Put the stone in the water and observe carefully.
  3. Measure the water level after the stone was put in the water and record it.
  4. Do subtraction: Water Level After – Water Level Before = Increased Depth (How much Deeper)
  5. Apply the formula and calculate. Volume = side × side × height (Increased depth)
- S** Use the steps to calculate for the volume of the stone.
 

Water level before: 4 cm Water level after: 5 cm (5 cm – 4 cm = 1 cm)

Volume = side × side × height (Increased depth)

= 10 cm × 10 cm × 1 cm

= 100 cm<sup>3</sup> (volume of the stone)

**3** **8** Investigate the volume of various object.

- S** Estimate the volume of various objects individually before submerging in the water.
- T/S** Find the volume of various objects using the steps above.

**4** Summary

- T** What have you learned in this lesson?
- S** Present ideas on what they have learned.
- T** Use students' ideas to confirm the important concepts of this lesson.

## Sample Blackboard Plan

<b>Date:</b>	<b>Chapter:</b> 6 Volume	<b>Sub-chapter:</b> 2. Formula for Volume.	<b>Lesson Number:</b> 5/5
--------------	--------------------------	--	---------------------------

**MT: Investigating the volume of various objects and shapes.**

**MT:** Introduce the main task here.

**Volumes of Various Shapes**

Physical objects have volumes.  
How can we find the volume other than the cube or rectangle prism?  
As an example, uneven shape such as rock can be calculated by putting in water.

**7** When you sink an object in water, its height will increase by the volume of an object. Let's find the volume of the rock below.

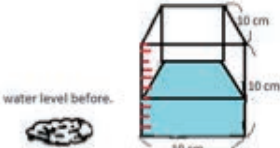

water level before.

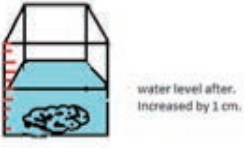

water level after.  
Increased by 1 cm.

Estimated volume of the stone: \_\_\_\_\_ cm<sup>3</sup>

Calculation of the volume of the stone.

Volume = side x side x height (increased depth)

= 10 x 10 x 1

= 100    **Answer: 100 cm<sup>3</sup> ( volume of the stone.)**

---

**8** Let's measure the volume of the various objects.

Display the volume calculation of the various objects on the board.  
Follow the steps and calculation done for the stone for other objects.

**Summary**

To understand how the volume of uneven shapes or irregular shapes such as a rock can be calculated by putting the object in water.

# Unit 6

## Unit: Volume Exercise, Problems and Evaluation Lesson 1 and 2 of 1

Textbook Page :  
086 and 087  
Actual Lesson 058 and 059

### Lesson Objective

- To confirm their understanding on the concepts they learned in this unit by completing the Exercise, Problems and the Evaluation Test confidently.

### Prior Knowledge

- All the contents covered in this unit

### Preparation

- Evaluation test copy for each student

### Assessment

- Complete the Exercise and Problems correctly. **S**

### Teacher's Notes

This is the last lesson of Chapter 6. Students should be encouraged to use the necessary skills learned in this unit to complete all the Exercises and solve the Problems in preparation for the evaluation test. The test can be conducted as assesment for your class after completing all the exercises. Use the attached evaluation test to conduct assesment for your class after finishing all the exercises and problems as a separate lesson.

### EXERCISE

- 1 Let's find the volume of the rectangular prism and the cube below.

①

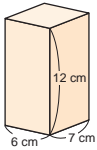

$$504 \text{ cm}^3$$

②

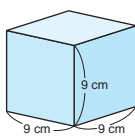

$$207 \text{ cm}^3$$

Pages 72, 78 and 79

- 2 What is the volume in  $\text{cm}^3$  and  $\text{m}^3$  for the rectangular prism on the right?

$$10\ 800\ 000 \text{ cm}^3$$

$$10.8 \text{ m}^3$$

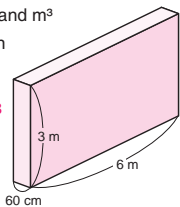

Pages 81 and 82

- 3 What is the volume of 400 L water in  $\text{cm}^3$  and  $\text{m}^3$ ?

$$400\ 000 \text{ cm}^3$$

$$0.4 \text{ m}^3$$

Page 83

- 4 Let's find the volume of the object on the right.

$$216 \text{ cm}^3$$

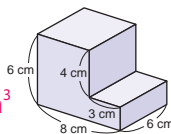

Pages 84 and 85

Let's calculate.

- ①  $30 \times 1.2 = 36$     ②  $5.4 \times 1.2 = 6.48$     ③  $2.13 \times 5.4 = 11.502$     ④  $0.12 \times 0.5 = 0.06$   
⑤  $9 \div 1.5 = 6$     ⑥  $4.5 \div 2.5 = 1.8$     ⑦  $6.12 \div 7.2 = 0.85$     ⑧  $1.61 \div 0.7 = 2.3$

Grade 5

Do You Remember?

$$86 = \square \times \square$$

### PROBLEMS

- 1 Let's find the volume of the following rectangular prism and cube.

Using the formula.

①

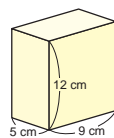

$$540 \text{ cm}^3$$

②

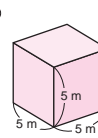

$$125 \text{ m}^3$$

- 2 Let's find the volumes below.

Considering the ways.

①

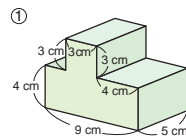

$$225 \text{ cm}^3$$

②

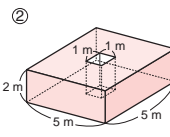

$$48 \text{ m}^3$$

- 3 Let's find the volume of a prism which could be made by the development on the right.

Calculating the volume from its development.

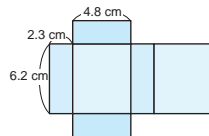

$$68.448 \text{ cm}^3$$

- 4 Let's fill the rectangular prism tank below with water. How many times do you need to pour water with a 10 L bucket?

Representing the volume of water by various units.

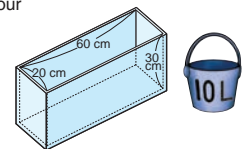

$$36 \text{ L}$$

$$\square - \square = 87$$

## Lesson Flow

### 1 Complete the Exercise

- S Solve all the exercises.
- T Confirm students' answers.
- TN
  - ① Finding volume of prism and cube.
  - ② and ③ Expressing same volume with different units.
  - ④ Finding the volume of a complex shape.

### 2 Solve the Problems

- S Solve all the problems.
- T Confirm students' answers.
- TN
  - ① Finding volume using formula.
  - ② Finding the volume in considering different ways.
  - ③ Calculating the volume from its development or net.
  - ④ Representing the volume of water by various units.

### 3 Complete the Evaluation Test

- TN Use the attached evaluation test to conduct assesment for your class after finishing all the exercises and problems as a seperate lesson.
- S Complete the Evaluation Test.

Chapter 6: Volume	Name:	Score / 100
----------------------	-------	----------------

1. The solids below are made up with cubes of  $1\text{cm}^3$  each. Find the volume of each solid.  
[2 x 20 marks = 40 marks]

(1)

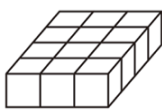

Answer: 12 cm<sup>3</sup>

(2)

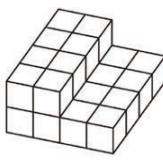

Answer: 24 cm<sup>3</sup>

2. Find the volume of each figure.  
[4 x 15 marks = 60 marks]

(1)

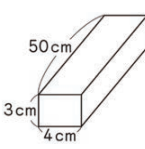

Answer: 600 cm<sup>3</sup>

(2)

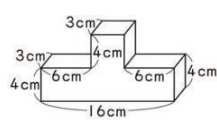

Answer: 240 cm<sup>3</sup>

(3)

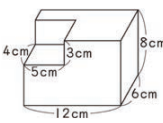

Answer: 516 cm<sup>3</sup>

(4)

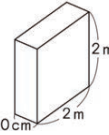

Answer: 2 m<sup>3</sup> or 2 000 000 cm<sup>3</sup>

118

**End of Chapter Test**

**Date:**

Chapter 6: Volume	Name:	Score  / 100
----------------------	-------	--------------------

1. The solids below are made up of cubes of  $1 \text{ cm}^3$  each. Find the volume of each solid.

[2 × 20 marks = 40 marks]

(1)

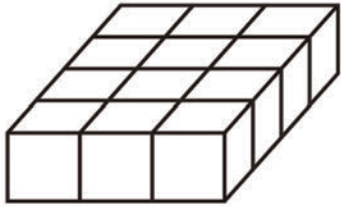

Answer:

(2)

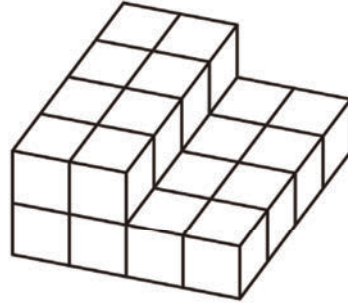

Answer:

2. Find the volume of each figure.

[4 × 15 marks = 60 marks]

(1)

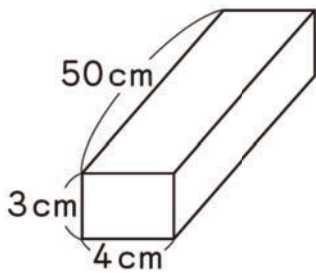

Answer:

(2)

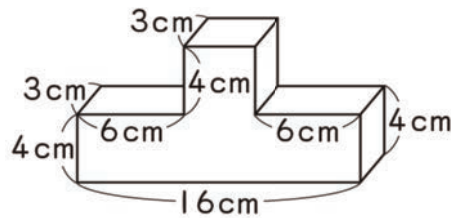

Answer:

(3)

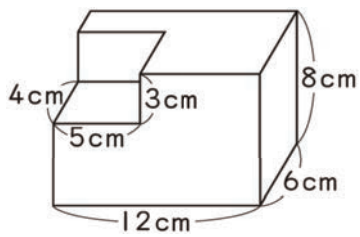

Answer:

(4)

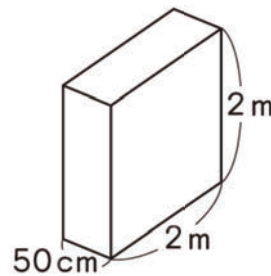

Answer:

# Chapter 7 Multiples and Divisors

## 1. Content Standard

5.1.8 Understand the properties of numbers and apply such properties to identify the component of numbers.

## 2. Unit Objectives

- Apply components of multiples and common multiples for finding the number patterns.
- To understand that whole numbers are classified into even numbers and odd numbers if we decide on a perspective.
- To understand and apply components of multiples and divisors for finding number patterns.
- Explain the relationship between multiples and divisors using the idea of prime numbers.

## 3. Teaching Overview

In this unit, students will understand whole numbers as elements of sets for which are multiples or divisors of certain numbers.

Students have some experiences of composing and decomposing numbers already. The learning in this unit will be utilised in the calculation of fractions.

### Multiples and Common Multiples :

Teachers encourage students to enjoy playing with multiples and common multiples by finding some patterns. They will find some patterns that pay attention to numbers on a specific number place. They can also enjoy finding a pattern of design when they paint some multiples and common multiples using specific colours of a number table.

They notice that multiples and common multiples are infinite. Some examples of utilisation in real life situations should be emphasised.

### Divisors and Common Divisors :

Divisors and Common divisors will be used in canceling fractions, study of square root, etc.

They are finite. Teachers should not impart how to find it, however students are supposed to be encouraged to find out divisors and common divisors by their motive, own initiative, independently and through motivational activities.

### Even Numbers and Odd Numbers :

Students understand the meaning of even and odd numbers such as even numbers are divisible by 2 and odd numbers have 1 as the remainder when divided by 2. They also look for some examples of using even and odd numbers in their daily lives.

## 4. Related Learning Contents

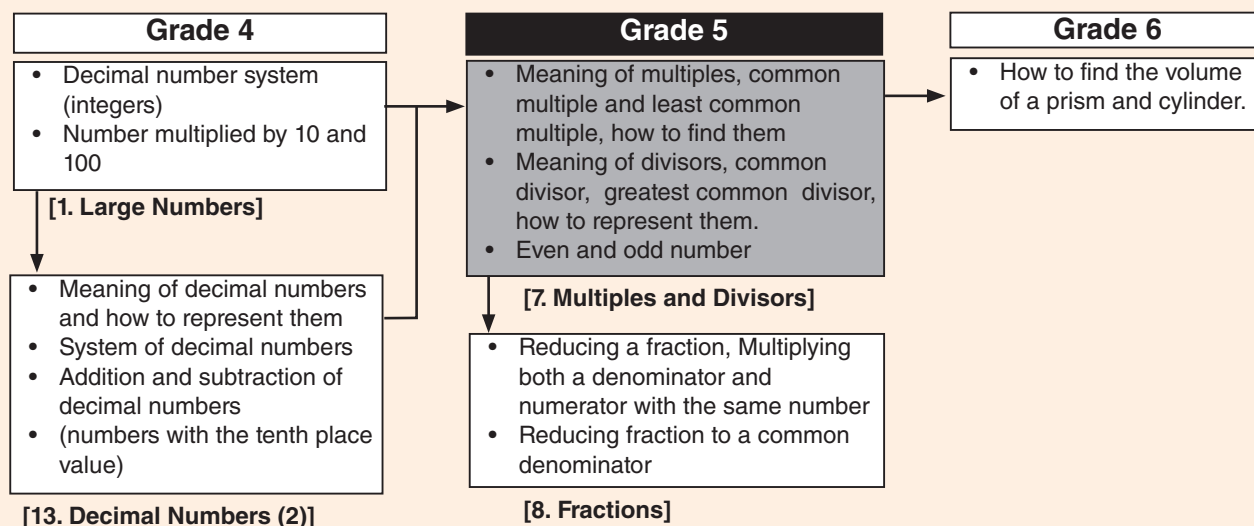

**Sub-unit Objectives**

- To understand multiples, common multiples and least common multiple and identify them.
- To understand the meaning of the least common multiple and use it for various situations.
- To deepen the understanding about rules for multiples by looking at how multiples are lined up.

**Lesson Objectives**

- To understand the meaning of multiples.
- To notice that multiples exist to infinite.

**Prior Knowledge**

- Multiplication table

**Preparation**

- Chart for the number lines in 1 and 2, 1 m ruler, table

**Assessment**

- Enjoy the 'Clap number game' considering multiples of 3. **F**
- Demonstrate the understanding of the meaning of multiples. **S**
- Solve the exercises correctly. **S**

**Teacher's Notes**

Multiples are the numbers that we get after multiplying a same number by any integer.

7

**Multiples and Divisors**



▶ Let's think about number groups. First, decide the "clap number".

For example, let's decide 3 as "clap number".

Make a circle and say the number in the order from one. When the count numbers is 3, each person claps, every 3rd person claps by saying the "clap number".

Until which number can you continue?

I considered how many students skipped the clap.

I considered to add 3 for every third student that claps.

1 2 3 4 5 6 7 8 9 10 11 12 13 14 15 16 17 18 19 20 21 22 23 24 25 26 27 28 29 30

31 32 33 34 35 36 37 38 39 40 41 42 43 44 45 46 47 48 49 50 51 52 53 54 55 56 57 58 59 60

Let's enjoy "Clap Number" game



**1 Multiples and Common Multiples**

**1 Multiples**

**1** When the "clap number" is 3, let's consider which numbers will be clapped.

**1** Write numbers in the table on the right and put colours on the number which will be clapped.

**2** Put colours on the numbers line below, too. Let's discuss what the groups of coloured numbers are.

1	2	3	4	5	6	7	8	9	10
11	12	13	14	15	16	17	18	19	20
21	22	23	24	25	26	27	28	29	30
31	32	33	34	35	36	37	38	39	40
41	42	43	44	45	46	47	48	49	50
51	52	53	54	55	56	57	58	59	60

31 32 33 34 35 36 37 38 39 40 41 42 43 44 45 46 47 48 49 50 51 52 53 54 55 56 57 58 59 60



## Lesson Flow

### 1 Play the “clap number” game.

- T** Explain the rule for “clap number” game and play the game making 3 a clap number.
- TN** Rule for the clap number game:
  - Call a number from 1.
  - When it comes to 3, clap your hand calling the number.
  - Do the same for every third number.
- S** Understand that the number to be clapped after 3 is 6 then 9, 12 15 etc...
- TN** Adjust the speed for counting numbers according to the students pace.
- T** Introduce the Main Task. (Refer to the BP)

### 2 1 Investigate what kind of numbers they clapped.

- T** If the clap number is 3, what kind of number will we clap?
- S** It is using the three times table.
- S** 1 2 Write number table in the exercise book and circle on the numbers to clap.
- T** Let's present the rules for the numbers to clap.
- S** It is the number added by 3 each time. It is using the three times table.

### 3 Important Point

- T/S** Explain the important point in the box

### 4 2 Investigate multiples of 2.

- T** Let students to play the number game to investigate the multiples of 2.
- S** Put circles on the number line for the numbers clapped and explain the rules for the multiples of 2.
- S** They are from the two times table. They are the numbers added by 2 each time.

### 5 Complete the Exercise

- S** Solve the selected exercises.
- T** Confirm students' answers.

### 6 Summary

- T** What have you learned in this lesson?
- S** Present ideas on what they have learned.
- T** Use students' ideas to confirm the important concepts of this lesson.

Page 90 of the textbook

**Multiples of 3** are whole numbers multiplied by 3 like  $3 \times 1, 3 \times 2, 3 \times 3, \dots$   
 $3 \times 0 = 0$ , but 0 is not a multiple of 3.

**2 Clap by multiples of 2**  
 Let's find the relationship of the numbers clapped.  
 Circle the clapped numbers on the number line below.

1 2 3 4 5 6 7 8 9 10 11 12 13 14 15 16  
 17 18 19 20 21 22 23 24 25 26 27 28 29 30 31 32  
 33 34 35 36 37 38 39 40 41 42 43 44 45 46 47 48  
 49 50 51 52 53 54 55 56 57 58 59 60 61 62 63 64

**Exercise**

1 Stack the boxes of cookies with a height of 5 cm.  
 ① What is the total height of 6 boxes?  
 $5 \times 6 = 30$  Answer: 30 cm.  
 ② Which multiple gives the total height?

**Multiple of 5**

2 Let's write the first 5 numbers of the following multiples.  
 ① Multiples of 8      ② Multiples of 9  
 8, 16, 24, 32, 40      9, 18, 27, 36, 45



## Sample Blackboard Plan

Date: \_\_\_\_\_ Chapter: 7 Multiples and Divisors Sub- chapter: 1. Multiples and Common Multiples Lesson Number: 1/3

MT: To investigate and understand the meaning of multiples.

Make a circle and say in the order from one, a person who becomes 3 claps by saying the “clap number”.

**1 Multiples and Common Multiples.**

MT: Introduce the main task here.

**1 Investigate what kind of numbers you clapped.**

1	2	3	4	5	6	7	8	9	10
11	12	13	14	15	16	17	18	19	20
21	22	23	24	25	26	27	28	29	30
31	32	33	34	35	36	37	38	39	40
41	42	43	44	45	46	47	48	49	50
51	52	53	54	55	56	57	58	59	60

**2 Put colour on the number line.**

1 2 3 4 5 6 7 8 9 10 11 12 13 14 15 16 17 18 19 20 21 22 23 24 25 26 27 28 29 30

31 32 33 34 35 36 37 38 39 40 41 42 43 44 45 46 47 48 49 50 51 52 53 54 55 56 57 58 59 60

**What did you notice from the clap game?**

- I Know how many children skip the clap.
- Adding by 3.
- The number that is coloured can be divided by 3.
- Multiple of 3.

Multiple of 3 are whole numbers multiplied by 3 like  $3 \times 1, 3 \times 2, 3 \times 3, \dots$   
 $0$  of  $3 \times 0$  is not a multiple of 3.

**2 Investigating multiples of 2.**  
 Circle the clapped numbers on the line below.

1 2 3 4 5 6 7 8 9 10 11 12 13 14 15 16 17 18 19 20

21 22 23 24 25 26 27 28 29 30

31 32 33 34 35 36 37 38 39 40

41 42 43 44 45 46 47 48 49 50

51 52 53 54 55 56 57 58 59 60

**What did you notice about the number line above.**

- These numbers identified are found in the 2 times table.
- There is only one number that is not circle.

**Exercise**  
 Complete exercise 1 and 2.

**Summary**  
 Playing the clap number game is a tool used for enjoyment to easily find the multiples of a number.

### Lesson Objectives

- To understand the meaning of common multiples and how to find them.
- To understand the meaning of the least common multiple and how to find it.

### Prior Knowledge

- Multiplication table

### Preparation

- Table of multiples of 2, 3, 4 and 5.
- Chart showing Mero's, Yamo's, Sare's and Vavi's Ideas

### Assessment

- Enjoy the 'Clap number game' considering multiples of 2 and 3. **F**
- Demonstrate the understanding of the meaning of common multiples and least common multiple. **S**

### Teacher's Notes

In playing the clap game, the students should be reminded of the main focus on the idea of identifying common multiples.

#### How Multiples Make Patterns in Numbers

Circle the multiples of 2 in the table below.  
How do the multiples of 2 line up?  
Let's check the multiples of other numbers.

Let's try the multiples of 3 as well.

#### Multiples of 2

1	2	3	4	5	6	7	8	9	10
11	12	13	14	15	16	17	18	19	20
21	22	23	24	25	26	27	28	29	30
31	32	33	34	35	36	37	38	39	40
41	42	43	44	45	46	47	48	49	50
51	52	53	54	55	56	57	58	59	60
61	62	63	64	65	66	67	68	69	70
71	72	73	74	75	76	77	78	79	80
81	82	83	84	85	86	87	88	89	90
91	92	93	94	95	96	97	98	99	100

#### Multiples of 3

1	2	3	4	5	6	7	8	9	10
11	12	13	14	15	16	17	18	19	20
21	22	23	24	25	26	27	28	29	30
31	32	33	34	35	36	37	38	39	40
41	42	43	44	45	46	47	48	49	50
51	52	53	54	55	56	57	58	59	60
61	62	63	64	65	66	67	68	69	70
71	72	73	74	75	76	77	78	79	80
81	82	83	84	85	86	87	88	89	90
91	92	93	94	95	96	97	98	99	100

#### Multiples of 4

1	2	3	4	5	6	7	8	9	10
11	12	13	14	15	16	17	18	19	20
21	22	23	24	25	26	27	28	29	30
31	32	33	34	35	36	37	38	39	40
41	42	43	44	45	46	47	48	49	50
51	52	53	54	55	56	57	58	59	60
61	62	63	64	65	66	67	68	69	70
71	72	73	74	75	76	77	78	79	80
81	82	83	84	85	86	87	88	89	90
91	92	93	94	95	96	97	98	99	100

#### Multiples of 5

1	2	3	4	5	6	7	8	9	10
11	12	13	14	15	16	17	18	19	20
21	22	23	24	25	26	27	28	29	30
31	32	33	34	35	36	37	38	39	40
41	42	43	44	45	46	47	48	49	50
51	52	53	54	55	56	57	58	59	60
61	62	63	64	65	66	67	68	69	70
71	72	73	74	75	76	77	78	79	80
81	82	83	84	85	86	87	88	89	90
91	92	93	94	95	96	97	98	99	100

### Common Multiples

- Let's play "clap number game" by raising hands at the multiples of 2 and clapping at the multiples of 3.



For 6, raise hands and clap at the same time, right?



Are there any other numbers which students raise hands and clap at the same time like 6?



Multiples of 2



Multiples of 3



Multiples of both 2 and 3

1	2	3	4	5	6	7	8	9	10	11	12	13	14	...
---	---	---	---	---	---	---	---	---	----	----	----	----	----	-----

- Let's find numbers that are multiples of both 2 and 3.



A number that is a multiple of both 2 and 3 is called a **common multiple** of 2 and 3. The smallest of all common multiples is called the **least common multiple**.

- What is the number of the least common multiple of 2 and 3? **6**

## Lesson Flow

**1** Review the previous lesson.

**2** How multiples make patterns in numbers.

**S** Circle the multiples of 2, 3 and others in the tables.

**3** **3** Play “clap number” game

**T** What rule was used in the clap game in yesterday’s lesson?

**S** Clap once for every multiple.

**T** **1** We are going to do clap number game again. We have a new rule today, raise both hands for the multiples of 2 and clap hands for the multiples of 3. Let’s see if you can do this well.

**S** Play the game several times and notice that the multiples of 2 and 3 are 6, 12, 18, 24, ....., etc.

**T** Introduce the Main Task. (Refer to the BP)

**4** Important Point

**T/S** Explain the important point in the box

**5** Find the least common multiple for 2 and 3

**S** **2** For 6, raise both hands and clap at the same time.

**S** When overlapping multiples of 2 and 3, raise hands and clap at the same time.

**6** **4** Find the common multiples of 3 and 4.

**S** Think about the common multiple based on four friends’ ideas.

**T** What are the common multiples of 3 and 4? Let’s explain how the four friends found the common multiples.

**S** Mero circled the same numbers among the multiples of 3 and 4.

**S** Yamo used the multiples of 3, Sare used the multiples of 4 and Vavi found the least common multiple, 12 and then found the multiples of 12.

**T** Confirm students’ ideas.

**7** Making tapes of Multiples

**TN** Students may complete the activity if time permits or do it as homework.

**8** Summary

**T** What have you learned in this lesson?

**S** Present ideas on what they have learned.

**T** Use students’ ideas to confirm the important concepts of this lesson.

**4** Let’s think about how to get the common multiples of 3 and 4. Four friends found different ways to determine the common multiples as follows. Let’s read their ideas and describe each method in sentences. Explain the ideas to your friends.

**Mero’s note**

multiples of 3    3, 6, 9, 12, 15, 18, 21, 24, 27, 30, 33, 36...

multiples of 4    4, 8, 12, 16, 20, 24, 28, 32, 36, 40 ...

I find the common numbers from the multiples of 3 and 4.

<p><b>Yamo’s note</b></p> <p>Think about multiples of 3... then, circle the multiples of 4.</p> <p>3, 6, 9, 12, 15  <del>×</del> <del>×</del> <del>×</del> <del>×</del>            18, 21, 24, 27 ...  <del>×</del> <del>×</del> <del>×</del></p>	<p><b>Sare’s note</b></p> <p>Write the multiples of 4 then, circle the multiples of 3.</p> <p>4, 8, 12, 16, 20,  <del>×</del> <del>×</del> <del>×</del> <del>×</del>            24, 28, 32, 36 ...  <del>×</del> <del>×</del> <del>×</del></p>	<p><b>Vavi’s note</b></p> <p>3, 6, 9, <u>12</u>            4, 8, <u>12</u></p> <p><math>12 \times 2 = (24)</math>, <math>12 \times 3 = (36)</math></p>
---	--	--

Making Tapes of Multiples

Place the tape of multiples of 2 on top of the tape of multiples of 3. The common multiples of 2 and 3 are where the holes on both tapes overlap.

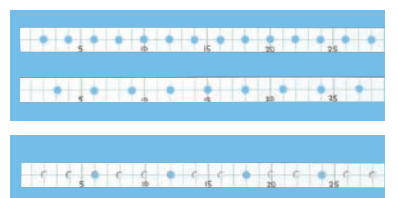

The holes show the multiples.



□ - □ = 93

Sample Blackboard Plan

Lesson 061 Sample Blackboard Plan is on page 125.

### Lesson Objectives

- To understand how to solve problems which require the least common multiple.
- To think about the concrete situations of using the least common multiple and deepen their understanding about common multiples and the least common multiple.

### Prior Knowledge

- Common multiples and least common multiple (Previous lesson)

### Preparation

- Diagram for **5**

### Assessment

- Solve the problem using multiple and least common multiple. **F**
- Solve the exercises correctly. **S**

### Teacher's Notes

For this lesson, use the picture of cookies and chocolates to get the idea of identifying multiples and common multiples. As the number of boxes increase, the common multiples can be easily identified.

### Lesson Flow

#### 1 Review previous lesson

#### 2 Important Point

**T/S** Explain the important point in the box

**T** Introduce the Main Task. (Refer to the BP)

#### 3 Think about the heights of cookie and chocolate boxes.

**T/S** **5** Read and understand the situation.

**T** **1** The total height of boxes of cookies is the multiples of which number?

**S** The multiples of 6.

**T** **2** The total height of chocolate boxes is the multiples of which number?

**S** The multiples of 8.

**T** **3** What will be the least height of the cookie boxes and chocolate boxes be equal?

**S** 24 cm high.

**T** How many boxes are there in each stack?

**S** 1. Cookies:  $\frac{24}{6} = 4$   
Answer: 4 boxes of cookies

The least common multiple of 3 and 4 is 12. All common multiples of 3 and 4 are multiples of 12.

- 5** Stacked are boxes of cookies with a height of 6 cm each and chocolate boxes with a height of 8 cm each.

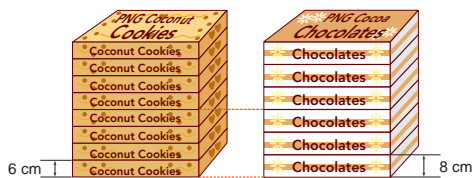

**1** The total height of the boxes of cookies are multiples of which number? **Multiple of 6.**

**2** The total height of the chocolate boxes are multiples of which number? **Multiple of 8.**

**3** What will be the least height that the cookie boxes and chocolate boxes be equal? How many boxes are in each stack?

**4** Write the first 3 numbers where the height of both stacks are equal.  
**6 x 4 = 24. Answer: 24 cm, 4 cookie boxes and 3 chocolate boxes**  
**24, 48, 72**

#### Exercise

**1** Write the first 4 common multiples for each of the following groups of numbers. Find the least common multiples.

**1** (5, 2) **2** (3, 9) **3** (4, 6) **12, 24, 36, 48**

**10, 20, 30, 40** **9, 18, 27, 36** **LCM = 12**

**LCM = 10** **LCM = 9**

**2** Stack boxes with heights of 6 cm and 9 cm. What is the smallest number where the total heights of the two stacks are equal?

**6cm box: 6, 12, 18**

**9cm box: 9, 18, 27** **Answer: 18 cm**

## Lesson Flow

2. Chocolates:  $\frac{24}{8} = 3$   
 Answer: 3 boxes of chocolates.

### 4 Find the common height of the 2 boxes.

**T** Let's find the first three heights where the height of both stacks are equal.

**S** 24 cm, 48 cm and 72 cm high.

### 5 Complete the Exercise

**S** Solve the selected exercises.

**T** Confirm students' answers.

### 6 Summary

**T** What have you learned in this lesson?

**S** Present ideas on what they have learned.

**T** Use students' ideas to confirm the important concepts of this lesson.

## Sample Blackboard Plan (Lesson 61)

Date: Chapter:7 Multiples and Multiples Sub- chapter:1. Multiples and Common Multiples Lesson Number: 2/3

**MT:** To understand the meaning of common and least common multiple and how to find it.

**3** Let's play "clap number" by raising hands at the multiples of 2 and clapping at the multiples of 3.

**Rules**

- Start by calling a number from 1 onwards.
- Hands up for the multiples of 2.
- Clap your hands for the multiples of 3.
- When both multiples of 2 and 3, hands up and clap your hands at the same time.

**1** Let's find numbers that are multiples of 2 and 3.

**Multiples of 2:** 2, 4, 6, 8, 10, 12, 14, 16, 18, ...

**Multiples of 3:** 3, 6, 9, 12, 15, 18, 21, 24, ...

**MT:** Introduce the main task here.

A number that is a multiple of both 2 and 3 is called **common multiple of 2 and 3**. The smallest of all common multiples is called the **least common multiple**.

**3** The least common multiple (LCM) of 2 and 3? **6**

**4** Let's find the common multiples of 3 and 4.

**Mero's idea**  
 I found the common numbers from multiples of 3 and 4 and circled it.

*Mero's note*

multiples of 3	3, 6, 9, 12, 15, 18, 21, 24, 27, 30, 33, 36
multiples of 4	4, 8, 12, 16, 20, 24, 28, 32, 36, 40

I find the common numbers from the multiples of 3 and 4.

**Vavi's idea**  
 I found the first common multiples of 3 and 4 which is 12, the first multiple, then  $12 \times 2 = 24$ , the second multiple and then next.

<b>Yano's note</b>	<b>Sara's note</b>	<b>Vavi's note</b>
Think about multiples of 3. Then circle the multiples of 4.	Write the multiples of 4 then circle the multiples of 3.	3, 6, 9, 12, 15, 18, 21, 24, 27, 30, 33, 36

**Summary**  
 A number that appears in both 2 and 3 is called a common multiple. The number smallest of all the multiples is called the least common multiple.

**Making Tapes of Multiples**  
 Place the tape of multiples of 2 on top of the tape of multiples of 3. The common multiples of 2 and 3 are where the holes on both tapes overlap.

## Sample Blackboard Plan (Lesson 62)

Date: Chapter:7 Multiples and Divisors. Sub- chapter:2. Multiples and Common Multiples. Lesson Number: 3/3

**MT:** To understand how to find the least common multiple using concrete situations.

The least common multiple of 3 and 4 is 12. All common multiples of 3 and 4 are multiples of 12.

**MT:** Introduce the main task here.

**5** Boxes of cookies with a height of 6cm each and chocolate candy boxes with a height of 8 cm each.

**1** The total height of the boxes of cookies are multiples of which number? **The multiple of 6**

**2** The total height of the chocolate boxes and multiples of which number? **The multiple of 8.**

**3** At what height will the total height of the cookie boxes and chocolate boxes be equal?  
 $6 \times 4 = 24$   
 How many boxes are in each stacks  
**4 cookies and 3 chocolate boxes.**

**4** Write the first 3 numbers where the height of both stacks are equal.

For the cookie boxes 6: 24, 48, 72  
 4 stacks, 8 stacks, 12 stacks

For the chocolate boxes 8: 24, 48, 72  
 3 stacks, 6 stacks, 9 stacks

**Exercise**  
 Complete exercise 1 and 2.

**Summary**  
 The smallest common multiple of 6 and 8 is 24. All common multiples of 6 and 8 are multiples of 24.

125

### Sub-unit Objectives

- To understand divisors, common divisors and the highest common divisor and how to find it.
- To find the highest common divisor according to the various concrete situations.

### Lesson Objective

- To understand the meaning of divisors and find them.

### Prior Knowledge

- Common multiples and least common multiples

### Preparation

- Square papers of  $1\text{ cm}^2$ ,  $2\text{ cm}^2$ ,  $3\text{ cm}^2$ ,  $4\text{ cm}^2$ ,  $6\text{ cm}^2$ ,  $9\text{ cm}^2$ ,  $18\text{ cm}^2$

### Assessment

- Investigate and explain the meaning of divisor through activity. **F**
- Demonstrate the understanding of the meaning of divisor. **S**

### Teacher's Notes

Prepare at least a square such as square of  $5\text{ cm}^2$  to show that there are some squares that cannot fit exactly in the  $12\text{ cm}$  and  $18\text{ cm}$  square length.

### Page 97 of the textbook

The lengths of the sides of the squares when lined up horizontally over a  $18\text{ cm}$  length without any gaps are  $1\text{ cm}$ ,  $2\text{ cm}$ ,  $3\text{ cm}$ ,  $6\text{ cm}$ ,  $9\text{ cm}$  and  $18\text{ cm}$ .

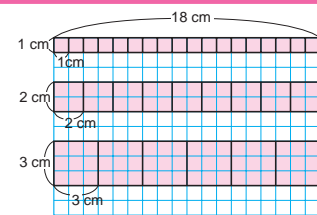

18 cm is included because we think only horizontally.

1, 2, 3, 6, 9, 18 ..... Divisors of 18

### 2 Divisors and Common Divisors

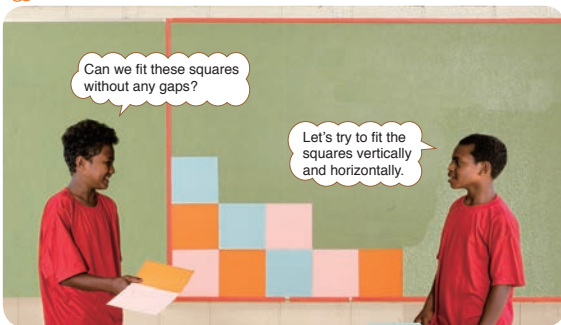

We want to put squares in this frame so there are no gaps.



Let's find out which squares can fit in the frame without any gaps.

#### Divisor

- Place squares of the same size in a  $12\text{ cm} \times 18\text{ cm}$  rectangle. How long is each side of the square?

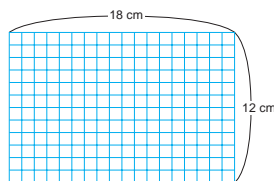

Think of the length of the sides of the squares when the squares are lined up vertically without any gaps.



- How many cm is each side of the squares when they are lined up vertically over a  $12\text{ cm}$  length without any gaps?

1 cm, 2 cm, 3 cm, 4 cm, 6 cm, 12 cm

$$\square - \square = 95$$

The lengths of the sides of the squares when lined up vertically over a  $12\text{ cm}$  length without any gaps are  $1\text{ cm}$ ,  $2\text{ cm}$ ,  $3\text{ cm}$ ,  $4\text{ cm}$ ,  $6\text{ cm}$  and  $12\text{ cm}$ .

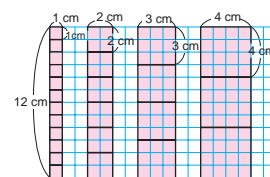

- Divide 12 by 1, 2, 3, 4, 6 and 12 one by one to confirm that there are no gaps. Are they divisible by 12?



**Yes, the numbers are divisible by 12**

The whole numbers by which 12 can be divided with no remainder are called **divisors** of 12.

1, 2, 3, 4, 6, 12 ..... Divisors of 12

- What can you find when divisors of 12 are grouped as shown below? **multiplying in each group gives us 12.**

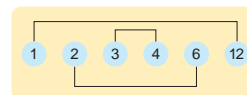

$$\begin{aligned} 1 \times 12 &= 12 \\ 2 \times 6 &= 12 \\ 3 \times 4 &= 12 \end{aligned}$$

Any number is divisible by 1 and itself.

Think about the length of the sides of the squares when the squares are lined up horizontally without any gaps.



- How many cm is each side of the squares when they are lined up horizontally over a  $18\text{ cm}$  length without any gaps?

1 cm, 2 cm, 3 cm, 6 cm, 9 cm, 18 cm

$$96 = \square \times \square$$

## Lesson Flow

### 1 Investigate and understand the meaning of divisors.

- T** Can we place squares without any gaps in a rectangle from the frame?
- S** 1. I think we cannot because the sizes of the length and the width are different.  
2. I think we can if we think carefully on how to place them.
- T** What length of the side of squares can be placed without any gaps?
- S** It seems we can place squares with the side of 1 cm or 2 cm in length but there seem to be more.
- T** Introduce the Main Task. (Refer to the BP)

### 2 Think of squares that can be lined up vertically without any gaps.

- T** Ask the students to place squares vertically on a 12 cm chart to see how many can fit without any gaps. (1 cm<sup>2</sup>, 2 cm<sup>2</sup>, 3 cm<sup>2</sup>, 4 cm<sup>2</sup>, 6 cm<sup>2</sup> and 12 cm<sup>2</sup> squares).
- T** How many cm is each side of the squares when they are lined up vertically over a 12 cm length without any gaps?
- TN** This activity should be done by the students before leading them to the next page for confirmation.
- S** The side lengths of the squares are: 1 cm, 2 cm, 3 cm, 4 cm, 6 cm and 12 cm.
- T** Confirm by lining the squares vertically on a 12 cm chart on page 96.
- T** **2** Are the side lengths of the squares divisible by 12?
- S** All the numbers are divisible by 12 without any remainder.

### 3 Important Point

- TS** Explain the important point in the box

### 4 Finding divisors of 12

- T** **3** How can we find the divisor of 12 without missing any number.
- S** It is good to find the pair of two numbers for multiplication like 1 and 12 of  $1 \times 12$ , 2 and 6 of  $2 \times 6$ .

### 5 Think of squares that can be lined up horizontally without any gaps.

- T** Ask students to place squares horizontally on a 18 cm chart to see how many can fit without any gaps. (1 cm<sup>2</sup>, 2 cm<sup>2</sup>, 3 cm<sup>2</sup>, 6 cm<sup>2</sup>, 9 cm<sup>2</sup> and 18 cm<sup>2</sup> squares).
- T** **4** How many cm is each side of the squares when they are lined up horizontally over a 18 cm length without any gaps?
- S** The side lengths of the squares are: 1 cm, 2 cm, 3 cm, 6 cm, 9 cm and 18 cm.
- T** Confirm by lining the squares horizontally on a 18 cm chart on page 97.
- TN** 1, 2, 3, 6, 9 and 18 are divisors of 18.

### 6 Summary

- T** What have you learned in this lesson?
- S** Present ideas on what they have learned.
- T** Use students' ideas to confirm the important concepts of this lesson.

## Sample Blackboard Plan

Date: \_\_\_\_\_ Chapter: 7. Multiples and Divisors Sub- chapter: 2. Divisors and Common Divisors Lesson Number: 1/4

**MT: To investigate and understand the meaning of divisors**

**1** Place squares of the same size in a 12cm x 18cm rectangle. How long in each side of the square?

Let's fit squares of 1cm, 2cm, 3cm, 4cm, etc in the rectangle to find out which size of squares can fit without any gaps.



1cm, 2cm, 3cm, 4cm, etc

**1** How many are there when they are lined up vertically over a 12cm length without any gaps? 1cm, 2cm, 3cm, 4cm, 6cm, 12cm.

**Squares lined up vertically**

1cm x 1cm
2cm x 2cm
3cm x 3cm
4cm x 4cm
6cm x 6cm
12cm x 12cm

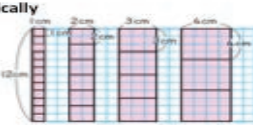

**2** Divide 12 by 1, 2, 3, 4, 6, and 12 one by one. Is it divisible? Yes, all numbers are divisible by 12 without any remainder.

The whole numbers by which 12 can be divided with no remainders (gaps) are called divisors of 12.  
 1, 2, 3, 4, 6, 12.....Divisors of 12

**3** What can you find when divisors of 12 are grouped as shown below?

1 2 3 4 6 12

$1 \times 12 = 12$   
 $2 \times 6 = 12$   
 $3 \times 4 = 12$

Any number is divisible by 1 and itself.

**4** Squares are lined up horizontally without any gaps over a 18 cm length. 1cm, 2cm, 3cm, 6cm, 9cm and 18cm.

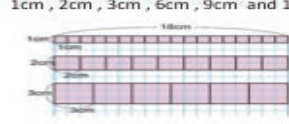

1, 2, 3, 4, 6, 12.....Divisors of 12

**Summary**  
The whole numbers by which 12 can be divided with no remainders (gaps) are called divisors of 12

**MT: Introduce the main task here.**

# Unit 7

## Unit: Multiples and Divisors Sub-unit 2: Divisors and Common Divisors Lesson 2 of 4

Textbook Page :  
097 and 098  
Actual Lesson 064

### Lesson Objective

- To understand the meaning of common divisors and the greatest common divisor and how to find them.

### Prior Knowledge

- Divisor

### Preparation

- Chart of numbers in 5
- Chart of Important Point

### Assessment

- Think about the meaning and how to find common divisors and greatest common divisors. **F**
- Solve the exercises correctly. **S**

### Teacher's Notes

Pairing of numbers can be used to confirm common divisors.

We get squares when the width and height are equal.

The lengths of the sides of the squares when lined up horizontally over a 18 cm length without any gaps are 1 cm, 2 cm, 3 cm, 6 cm, 9 cm and 18 cm.

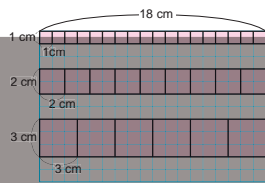

18 cm is included because we think only horizontally.

1, 2, 3, 6, 9, 18 ..... Divisors of 18

#### Common Divisors

- 5 How many cm can the sides of the squares be, when lined up vertically and horizontally without any gaps?

Height..... 1 2 3 4 6 12 (cm)

Width..... 1 2 3 6 9 18 (cm)

We get squares when the width and height are equal.

1 cm, 2 cm, 3 cm and 6 cm.

The numbers that are divisors of both 12 and 18 are called **common divisors** of 12 and 18. The largest of all common divisors is called **greatest common divisor**.

- 6 The common divisors of 12 and 18 are 1, 2, 3 and 6.  
What is the greatest common divisor of 12 and 18?

#### Exercise 6

- 1 Find all the divisors of 6, 8 and 36 respectively.  
For 6: 1, 2, 3, 6 For 8: 1, 2, 4, 8  
For 36: 1, 2, 3, 4, 6, 8, 9, 12, 18, 36
- 2 Write all the common divisors of 8 and 36.  
1, 2, 4

□ - □ = 97

- 2 Let's think about how to find the common divisors of 18 and 24. Two friends calculated common divisors in different ways in their exercise books but did not complete. Complete their ideas by considering their thinking.

Divisors of 18, 1 2 3 6 9 18  
Divisors of 24, 1 2 3 4 6 8 12 24

Common divisors: 1, 2, 3 and 6

Divisors of 18 1, 2, 3, 6, 9, 18  
24 ÷ 1 = 24, 24 ÷ 2 = 12, 24 ÷ 3 = 8, 24 ÷ 6 = 4  
24 ÷ 9 = 2 r 6, 24 ÷ 18 = 1 r 6

'x' means wrong, not a common divisor

- 3 Let's find all the common divisors and then find the greatest common divisors.

1 (8, 16) 2 (15, 20) 3 (12, 42) 4 (13, 9)  
1, 2, 4, 8 1, 3, 5, 15 1, 2, 3, 4, 6, 12 1, 13  
1, 2, 4, 8, 16 1, 2, 4, 5, 10, 20 1, 2, 3, 6, 14, 21 1, 3, 9  
There are some pairs of numbers like 1, that have only 1 as a common divisor.

#### Exercise

- 1 We want to divide 8 pencils and 12 exercise books equally amongst the students.  
What should be the appropriate number of students for distribution? 1, 2, 4, 8 Answer: 4 children  
1, 2, 3, 4, 6, 12

98 = □ × □



## Lesson Flow

### 1 Review the previous lesson.

- S We studied divisors of 12 and 18.
- T Today let's find squares which can be placed vertically as well as horizontally.
- T Introduce the Main Task. (Refer to the BP)

### 2 Investigate and understand the meaning of common divisors.

- T 5 How many cm can the sides of the squares be, when lined up vertically and horizontally without any gaps?
- S Squares with the side length of 1 cm, 2 cm, 3 cm and 6 cm can be placed without any gaps.

### 3 Important Point

- T/S Explain the important point in the box  .

### 4 Find the greatest common divisor

- T 6 What is the greatest common divisor of 12 and 18?
- S The greatest common divisor is the greatest number among the common divisors, so it is 6.

### 5 Complete the Exercise

- S Solve the exercises.
- T Confirm students' answers.

### 6 2 Find the common divisors of 18 and 24.

- T Study the two students' ideas and complete their thinking in your exercise books.
- S 1. Pair the common divisors of 18 and 24 then identify the greatest common divisor which is 6.  
2. Divide all the divisors of 18 into 24 and realise that 1, 2, 3, and 6 are divisible while 9 and 18 have remainders, therefore 9 and 18 are not common divisors.
- T Confirm that divisors that are common are divisible and divisors that are not common are not divisible.

### 7 3 Find the greatest common divisor.

- T Ask the students to complete 1 to 4.
- S Complete the activities by finding all the common divisors and the greatest common divisor.
- TN In activity 4, 1 is the only common divisor.

### 8 Complete the Exercise

- S Solve the exercise.
- T Confirm students' answers.

### 9 Summary

- T What have you learned in this lesson?
- S Present ideas on what they have learned.
- T Use students' ideas to confirm the important concepts of this lesson.

## Sample Blackboard Plan

Date: Chapter:7 Multiples and Divisors    Sub- chapter:2. Divisors and Common Divisors    Lesson Number: 2/4

**MT:** To investigate and understand the meaning of common divisors and greatest common divisors.

**Common Divisors**

**MT:** Introduce the main task here.

5 How many cm can the sides of the squares be when lined up vertically and horizontally without any gaps?

12 cm

Height.....1, 2, 3, 4, 6, 12 (cm)

Width.....1, 2, 3, 6, 9, 18 (cm)

18cm      Common: 1cm, 2cm, 3cm, 6cm.

The numbers that are divisors of both 12 and 18 are called **common divisors** of 12 and 18. The largest of all common divisors is called **greatest common divisor**.

The common divisors of 12 and 18 are 1, 2, 3 and 6.

6 What is the greatest common divisor of 12 and 18? 6

**Exercise**

1 Find all the divisors of 6, 8 and 36, respectively.

For 6: 1, 2, 3, 6      For 8: 1, 2, 4, 8

2 Write all the common divisors of 8 and 36.

For 18: 1, 2, 3, 6, 9, 18      Common divisors: 1, 2 and 4

For 36: 1, 2, 3, 4, 6, 9, 12, 18, 36

2 Let's think about how to find the common divisors of 18 and 24.

Divisors of 18: 1, 2, 3, 6, 9, 18

Divisors of 24: 1, 2, 3, 4, 6, 8, 12, 24

Common divisors: 1, 2, 3 and 6

Divisors of 18: 1, 2, 3, 6, 9, 18

24 ÷ 2 = 12, 24 ÷ 3 = 8, 24 ÷ 4 = 6

24 ÷ 9 = 2 r 6, 24 ÷ 18 = 1 r 6

Common divisors: 1, 2, 3 and 6

3 Let's find the common divisors and the greatest common divisors.

1 8: 1, 2, 3, 8    2 15: 1, 3, 5, 15    3 12: 1, 2, 3, 4, 6, 12

16: 1, 2, 4, 8, 16    20: 1, 2, 4, 5, 10, 20    42: 1, 2, 3, 6, 14, 21

The numbers that 4 13, 1 13, 9 3, 9

There are some pairs of numbers like 4, that have 1 as a common divisor.

**Exercise** - complete exercise.

**Summary**

Common divisors are identified from the divisors of any two numbers.

The largest of all common divisors is the greatest common divisor.

# Unit 7

## Unit: Multiples and Divisors Sub-unit 2: Divisors and Common Divisors Lesson 3 of 4

Textbook Page :  
099 and 100  
Actual Lesson 065

### Lesson Objectives

- To understand the relationship between multiples and divisors.
- To investigate about prime numbers.

### Prior Knowledge

- Multiples and least common multiples
- Divisors and greatest common divisors

### Preparation

- Square cards

### Assessment

- Investigate the relationship between multiples and divisors. **F**
- Investigate prime numbers. **S**
- Explain the meaning of prime numbers. **S**

### Teacher's Notes

1 is not a prime number because it is always the divisor as stated in the definition.

#### The Relationship between Multiples and Divisors

4 Let's think about the divisors of 18.

1 Find the divisors of 18 by arranging 18 square cards to make rectangles.

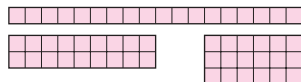

2 Is 18 a multiple of the divisors you found in 1?

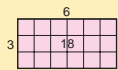

- 3 and 6 are divisors of 18.
- 18 is a multiple of 3 and 6.

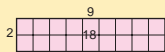

- 2 and 9 are divisors of 18.
- 18 is a multiple of 2 and 9.

#### Prime Numbers

Some numbers like 2, 3, 5 and 7 are divisible only by 1 and itself. Find such numbers amongst the following numbers. Divide by 2, 3, 4... in order to find them.

2	3	4	5	6	7	8	9	10	11
12	13	14	15	16	17	18	19	20	21
22	23	24	25	26	27	28	29	30	31
32	33	34	35	36	37	38	39	40	41



A number that can be divided only by one and itself is called a **prime number**. One is not a prime number.

#### Using Prime Numbers

5 Let's represent whole numbers by a product form of prime number.

1 Express 6 by a product form of a prime number.

2 Express 30 by a product form of a prime number.

$$30 = 5 \times 6$$

$$= 5 \times 3 \times 2$$

Let's find divisors of 6.

3 Determine divisors of 30 by using the expression in 2.



2, 3 and 5 are easily found as divisors.

Divisor of 30 is the product of the combination of prime numbers.



6 Let's determine the greatest common divisor of 24 and 36 by using a prime number.

$$24 = 4 \times 6$$

$$= 2 \times 2 \times 2 \times 3$$

$$36 = 6 \times 6$$

$$= 2 \times 3 \times 2 \times 3$$

$$= 2 \times 2 \times 3 \times 3$$

When the multiples representations of prime numbers products are compared, it is common to,  $2 \times 2 \times 3 = 12$ .

Then, the greatest common divisor is 12.

Using multiple representation of prime number products, let's find the numbers that should be multiplied to get the same products?

7 Let's discuss how to determine the least common multiple of 24 and 36 by using a prime number.



$$24 \times \square = 2 \times 2 \times 2 \times 3 \times \square$$

$$36 \times \square = 2 \times 2 \times 3 \times 3 \times \square$$

$$\square - \square = 99$$

$$100 = \square \times \square$$

## Lesson Flow

**1** Review the previous lesson.

**2** **4** Investigate and understand the relationship between divisors and multiples.

**T** Introduce the Main Task. (Refer to the Blackboard Plan)

**T** **1** Let's find divisors of 18 by arranging squared cards to a rectangle.

**S** Think by arranging cards.

**S** Divisors of 18 are 1, 2, 3, 6, 9, and 18.

**3** **2** Think about how to find the multiples of divisors.

**T** Is 18 a multiple of the divisors you found in **1**?

**S** They are all divisors of 18 because they are  $1 \times 18$ ,  $2 \times 9$ , and  $3 \times 6$ .

**T** What kind of rules are there between multiples and divisors?

**S** If we multiply the pairs for finding the divisors like 1 and 18, 2 and 9, all the answers are 18.

**S** All the divisors of 18 are multiples of 18.

**4** Investigate and understand prime numbers .

**T/S** Read and understand the meaning of having only 1 and the number itself as divisors by using 2, 3, and 5.

**T** Let's find the numbers that can be divided only by 1 and itself.

**S** They are 2, 3, 5, 7, 11, 13, 17, 19, 23, 29, 31, 37, and 41.

**5** Important Point

**T/S** Explain the important point in the box  .

**6** Summary

**T** What have you learned in this lesson?

**S** Present ideas on what they have learned.

**T** Use students' ideas to confirm the important concepts of this lesson.

### Sample Blackboard Plan

Date: \_\_\_\_\_ Chapter:7. Multiples and Divisors Sub- chapter:2. Divisors and Common Divisors Lesson Number: 3/4

**MT:** To investigate the relationship between multiples, divisors and prime numbers.

**MT:** Introduce the main task here.

**4** Let's think about the divisors of 18.

**1** Find the divisors of 18 by arranging 18 square cards to make rectangles.

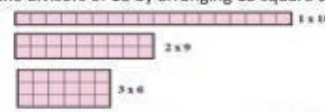

**2** Is 18 multiple of the divisors you found in **1**?  
This is arranged horizontal

3 and 6 are divisors of 18.  
18 is a multiples of 3 and 6.

2 and 9 are divisors of 18.  
18 is a multiples of 2 and 9.

1, 2, 9, 18

Arrange vertically.

1.  $18 \times 1$
2.  $9 \times 2$
3.  $6 \times 3$

**Prime Numbers**

Some number like 2, 3, 5 and 7 are divisible by only 1 and itself. Find such numbers from among the following numbers. Divide by 2, 3, 4... in order to find them.

2	3	4	5	6	7	8	9	10	11
12	13	14	15	16	17	18	19	20	21
22	23	24	25	26	27	28	29	30	31
32	33	34	35	36	37	38	39	40	41

**Summary**

A number that can be divided only by one and itself is called **prime number**. One is not a prime number.

131

### Lesson Objectives

- To represent whole numbers as a product of prime numbers.
- To find the greatest common divisor and the least common multiple.

### Prior Knowledge

- Multiple and least common multiple
- Divisor and greatest common divisor
- Prime number

### Preparation

- Chart of Kapul call out in task 7

### Assessment

- Apply prime numbers to find the greatest common divisor and the least common multiple. **F**
- Find the greatest common divisor and the least common multiple by using prime numbers. **S**

### Teacher's Notes

- Sieve of Eratosthenes is a process of straining numbers leaving prime numbers.
- To find the least common multiple of 24 and 36, multiply 24 by 3 and 36 by 2 to get 72 as the least common multiple.



A number that can be divided only by one and itself is called a **prime number**. One is not a prime number.

### Representing whole numbers as a product of prime numbers

#### Using Prime Numbers

5 Let's represent whole numbers by a product form of prime number.

- Express 6 by a product form of a prime number.  $2 \times 3$  or  $3 \times 2$
- Express 30 by a product form of a prime number.

$$30 = 5 \times 6$$

$$= 5 \times 3 \times 2$$

1, 2, 3, 5, 6, 10, 15, 30

Let's find divisors of 6.

3 Determine divisors of 30 by using the expression in 2.



2, 3 and 5 are easily found as divisors.

Divisor of 30 is the product of the combination of prime numbers.



### Finding greatest common divisors using prime numbers

6 Let's determine the greatest common divisor of 24 and 36 by using a prime number.

$$24 = 4 \times 6 = 2 \times 2 \times 2 \times 3$$

$$36 = 6 \times 6 = 2 \times 3 \times 2 \times 3 = 2 \times 2 \times 3 \times 3$$

When the multiples representations of prime numbers products are compared, it is common to,  $2 \times 2 \times 3 = 12$ .

Then, the greatest common divisor is 12.

Using multiple representation of prime number products, let's find the numbers that should be multiplied to get the same products?

$$24 \times \square = 2 \times 2 \times 2 \times 3 \times \square$$

$$36 \times \square = 2 \times 2 \times 3 \times 3 \times \square$$

7 Let's discuss how to determine the least common multiple of 24 and 36 by using a prime number.



100 =  $\square \times \square$

$\square - \square = 101$

### Sieve of Eratosthenes

Determine a prime number that is less than 100 by the next procedure.

- Erase 1.
- Leave 2 and erase multiple of 2.
- Leave 3 and erase multiple of 3.

Leave the first numbers and erase its multiples. Using this method, a prime number like 2, 3, 5, 7, 11, etc. are left.

Using this method, find a prime number until 100.

1	2	3	4	5	6	7	8	9	10
11	12	13	14	15	16	17	18	19	20
21	22	23	24	25	26	27	28	29	30
31	32	33	34	35	36	37	38	39	40
41	42	43	44	45	46	47	48	49	50
51	52	53	54	55	56	57	58	59	60
61	62	63	64	65	66	67	68	69	70
71	72	73	74	75	76	77	78	79	80
81	82	83	84	85	86	87	88	89	90
91	92	93	94	95	96	97	98	99	100

How many prime numbers are there?



Sieve of Eratosthenes is a method that was discovered by a mathematician named Eratosthenes in ancient Greece. He was born in BC (Before Christ) 276 and died BC 194.

## Lesson Flow

**1** Review the previous lesson.

**2** **5** Represent whole numbers by a product form of prime numbers.

**T** Introduce the Main Task. (Refer to the BP)

**T** **1** Express 6 as a product form of a prime number.

**S**  $3 \times 2$

**T** **2** What about 30?

**S**  $5 \times 6 = 5 \times 3 \times 2$

**3** Think about how to find divisors of 30.

**T** **3** Determine divisors of 30 by using the expression in **2**.

**S**  $30 = 5 \times 3 \times 2$

**TN** 2, 3, 5 can be found easily from  $2 \times 3$  and  $5 \times 3$ .  
6 and 15 can be found from  $6 \times 5$  and  $15 \times 3$ .  
Remember  $1 \times 30 = 30$  so 1 can be a divisor of 30. So, the divisors of 30 are 1, 2, 3, 5, 6, 15 and 30.

**4** **6** Think about how to find the greatest common divisor of 24 and 36 by using a prime number.

**T** Show 24 as a product form of prime numbers?

**S**  $24 = 2 \times 2 \times 2 \times 3$

**T** Show 36 as a product form of prime numbers?

**S**  $36 = 2 \times 2 \times 3 \times 3$

**T** Which number is common for both 24 and 36?

**S**  $2 \times 2 \times 3$

**S** Greatest common divisor is  $2 \times 2 \times 3 = 12$ .

**5** Think about how to find the least common multiple of 24 and 36 by using a prime number.

**T** **7** How can we find the least common multiple using the product form of prime numbers?

**S**  $24 \times 3 = 2 \times 2 \times 2 \times 3 \times 3$

$36 \times 2 = 2 \times 2 \times 3 \times 3 \times 2$

To find the least common multiple of 24 and 36, multiply 24 by 3 and 36 by 2 to get 72 as the least common multiple.

**T** Let students know that prime numbers are useful in finding divisors, greatest common divisors and least common multiples.

**6** Summary

**T** What have you learned in this lesson?

**S** Present ideas on what they have learned.

**T** Use students' ideas to confirm the important concepts of this lesson.

## Sample Blackboard Plan

Date: \_\_\_\_\_ Chapter: 7. Multiples and Divisors Sub-chapter: 2 Divisors and Common Divisors Lesson Number: 4/4

MT: To represent whole numbers as products of prime numbers.

MT: Introduce the main task here.

**5** Let's represent whole numbers by a product form of prime numbers.

**1** Express 6 in a product form of a prime number.  
 $2 \times 3$  or  $3 \times 2$

**2** What about 30 when we express it in a product form of a prime number?  
 $30 = 5 \times 6$   
 $= 5 \times 3 \times 2$

**3** Determine divisors of 30 by using the expression of **2**.  
2, 3, 5, 6, 15

2, 3 and 5, are easily found as divisors.

**6** Divisors of 30 is the product of the combination of prime numbers.

Let's find the greatest common divisor of 24 and 36 by using the product form of prime number.

$24 = 4 \times 6$   
 $= 2 \times 2 \times 2 \times 3$

$36 = 6 \times 6$   
 $= 2 \times 3 \times 2 \times 3$  or  
 $= 2 \times 2 \times 3 \times 3$

When the multiples representations of prime numbers products are compared, it is common to,  $2 \times 2 \times 3 = 12$ .  
Then, the greatest common divisor is 12.

**7** Let's find the least common multiple of 24 and 36 by using the product form of prime number.

$24 \times 3 = 2 \times 2 \times 2 \times 3 \times 3$

$36 \times 2 = 2 \times 2 \times 3 \times 3 \times 2$

Answer: The greatest common multiple is 12.

**Summary**  
If we use prime numbers, we can find divisors, the greatest common divisor and the least common multiples.

**Activity**  
Sieve of Eratosthenes can be done orally in class.

# Unit 7

## Unit: Multiples and Divisors Sub-unit 3: Even Numbers and Odd Numbers Lesson 1 of 1

Textbook Page :  
102  
Actual Lesson 067

### Sub-unit Objective

- To understand the meaning and characteristics of even and odd numbers.

### Lesson Objective

- To understand that whole numbers can be divided into even and odd numbers and know the meaning and characteristics of them.

### Prior Knowledge

- Whole numbers, divisors and Prime numbers

### Preparation

- Chart of important point
- Chart of tasks 1 and 2

### Assessment

- Identify the characteristics of even and odd numbers when dividing by 2. **F**
- Investigate where even and odd numbers are used in our surroundings. **F**
- Demonstrate the understanding of the characteristics of even and odd number. **S**

### Teacher's Notes

- Since odd numbers and even numbers are used in various places around us, searching for "even numbers" and "odd numbers" in our daily lives can be given as a homework.

### 3 Even Numbers and Odd Numbers

- Divide numbers from 0 to 20 into 2 groups by writing them alternately in the two rows below. Start with 0 in the upper row and then 1 in lower row, upper row, lower row, ...sequentially.

0, 2, 4, 6, 8, 10, 12, 14, 16, 18, 20

1, 3, 5, 7, 9, 11, 13, 15, 17, 19

- Divide the numbers in each row by 2.
- What did you notice when dividing numbers in each row?

- Arrange the whole numbers into 2 groups as shown below.

(A) 0, 18, 36...  
176, 212...

(B) 1, 19, 37...  
177, 213 ...

- In which group does 23 belong? How about 98?
- What rule did you apply when dividing?



23 belongs to group B and 98 belongs to group A  
Numbers with remainder to one group and numbers without reminders to another group

For the whole numbers, the numbers that can be divided by 2 without remainder are called **even numbers** and numbers that can be divided by 2 and leaves a remainder 1 are called **odd numbers**.

- Identify some situations where we can use even and odd numbers?

Flight No	Time	Departure	Arrival	Time
PX240	08:40	POM	HKN	09:45
PX241	10:15	HKN	POM	11:20
PX110	12:55	POM	MAG	13:05
PX111	13:35	MAG	POM	14:35
PX186	15:20	POM	HGU	16:20
PX187	16:50	HGU	POM	17:50
PX113	07:00	MAG	POM	08:00
PX120	09:00	POM	WWK	10:20
PX121	10:50	WWK	POM	12:10
PX184	12:55	POM	HGU	13:55
PX185	14:25	HGU	POM	15:25

The flight numbers such as PX240 and PX110 that depart from POM are even numbers. The flight numbers such as PX241 and PX111 that arrive in POM are odd numbers.

How about the scores in sports?



## Lesson Flow

### 1 Divide the numbers from 0 to 20 into even and odd numbers.

- T Introduce the Main Task. (Refer to the BP)
- T/S **1** Read and understand the situation.
- S Fill in the rows with numbers into two groups.
- S **1** Investigate by dividing the numbers in each row by 2.
- T **2** What did you notice when dividing numbers in each row?
- S Numbers divided by 2 on the upper row have no remainder whereas in the lower row, they have remainder of 1.

### 2 Dividing the whole numbers into two groups.

- T/S **2** Arrange the whole numbers into two groups as shown in **(A)** and **(B)**.
- T **3** Which group does 23 and 98 belong to, **(A)** or **(B)**?
- S 23 belongs to group **(B)** and 98 belongs to group **(A)**.
- T **4** What rule did you apply for dividing the two numbers into two groups?
- S Grouping is done according to dividing by 2 with remainders and without remainders.

### 3 Important Point

- T/S Explain the important point in the box  .

### 4 **3** Think about how even and odd numbers are used in our surroundings.

- T/S Discuss the flight schedule to identify even and odd numbers.
- T In what other places or situations are even and odd numbers used?
- S Possible responses: scores in sports games, temperature, rise and fall of sea levels, etc...

### 5 Summary

- T What have you learned in this lesson?
- S Present ideas on what they have learned.
- T Use students' ideas to confirm the important concepts of this lesson.

## Sample Blackboard Plan

Date: \_\_\_\_\_ Chapter: Multiples and Divisors Sub-chapter : 3 Even Numbers and Odd Numbers Lesson Number: \_\_\_\_\_

MT: To understand the meaning of even and odd numbers.

MT: Introduce the main task here.

**1** Divide numbers from 0 – 20 into 2 groups by writing them alternately in the two rows below. Start with 0 in the upper row, and then 1 in lower row, ..... sequentially.

**1** Divide the numbers in each row by 2.

0, 2, 4, 6, 8, 10, 12, 14, 16, 18, 20

1, 3, 5, 7, 9, 11, 13, 15, 17, 19

**2** What kind of numbers are divided in these two rows?

Numbers multiplied by 2 can also be divided by 2 without remainder.  
 Numbers that increases when 2 is added.  
 Numbers that can be divided by 2 but with remainders.

**2** Divide the whole numbers into 2 groups as shown below.

(A)

0, 18, 36,  
176, 212, ...

(B)

1, 19, 37,  
177, 213, ...

**1** In which group does 23 belong? **23 belongs to group B (odd numbers)**  
 How about 98? **98 belongs to group A (even numbers)**

**2** What rule did you apply for dividing?  
**Whether these numbers are divisible by 2 or not.**

For the whole numbers, the numbers that can be divided by 2 without remainder are called **even numbers** and numbers that can be divided by 2 and leave a remainder 1 are called **odd numbers**.

**3** Identify some situations where we can use even and odd numbers from the flight schedules from Air Niugini?

Depart from POM are **even numbers**  
 Arrive in POM are **odd numbers**.

**Summary**  
**Even Numbers:** Whole numbers that can be divided by 2 without any remainder.  
**Odd Numbers:** Whole numbers which can be divided by 2 and leave a remainder 1.

P 135

# Unit 7

## Unit: Multiples and Divisors Exercise, Problems and Evaluation Lesson 1 and 2 of 2

Textbook Page :  
103 and 104  
Actual Lesson 068 and 069

### Lesson Objective

- To confirm their understanding on the concepts they learned in this unit by completing the Exercise, Problems and the Evaluation Test confidently.

### Prior Knowledge

- All the contents covered in this unit

### Preparation

- Evaluation test copy for each student

### Assessment

- Complete the Exercise and Problems correctly. **S**

### Teacher's Notes

This is the last lesson of Chapter 7. Students should be encouraged to use the necessary skills learned in this unit to complete all the Exercises and solve the Problems in preparation for the evaluation test. The test can be conducted as assesment for your class after completing all the exercises. Use the attached evaluation test to conduct assesment for your class after finishing all the exercises and problems as a separate lesson.

### EXERCISE

- ① Let's think about numbers up to 50. Pages 88 and 98
- |    |    |    |    |    |    |    |    |    |    |
|----|----|----|----|----|----|----|----|----|----|
| 1  | 2  | 3  | 4  | 5  | 6  | 7  | 8  | 9  | 10 |
| 11 | 12 | 13 | 14 | 15 | 16 | 17 | 18 | 19 | 20 |
| 21 | 22 | 23 | 24 | 25 | 26 | 27 | 28 | 29 | 30 |
| 31 | 32 | 33 | 34 | 35 | 36 | 37 | 38 | 39 | 40 |
| 41 | 42 | 43 | 44 | 45 | 46 | 47 | 48 | 49 | 50 |

- Make a list of the multiples of 3.  
*3, 6, 9, 12, 15, 18, 21, 24, 27, 30, 33, 36, 39, 42, 45, 48*
- Make a list of the multiples of 7.  
*7, 14, 21, 28, 35, 42, 49*
- Make a list of the common multiples of 3 and 7.
- Make a list of the divisors of 28.  
*1, 2, 4, 7, 14, 28*
- Make a list of the divisors of 32.  
*1, 2, 4, 8, 16, 32*
- Make a list of the common divisors of 28 and 32.  
*1, 2, 4*

- ② Let's write the first 3 common multiples of the following pairs of numbers. Then, find the least common multiples. Pages 92 to 94
- (3, 6)      ② (8, 10)      ③ (3, 5)  
*6, 12, 18      40, 80, 120      15, 30, 45*

- ③ Let's find all the common divisors of the following pairs of numbers. Then, find the greatest common divisors. Pages 95 to 98
- (6, 12)      ② (18, 20)      ③ (32, 42)  
*1, 2, 3, 6      1, 2      1, 2*

Express the next volume and length by a mixed fraction and an improper fraction. Grade 4

**Do you remember?**

①  $2\frac{2}{3}$  dL       $\frac{8}{3}$  dL      ②  $1\frac{2}{5}$  m       $\frac{7}{5}$  m

$\square - \square = 103$

### PROBLEMS

- Let's write 3 multiples of the following numbers from the smallest to largest. Find all the divisors for them.  
*Finding multiples and divisors.*  
① 16 *16, 32, 48*    ② 13 *13, 26, 39*    ③ 24 *24, 48, 72*  
*1, 2, 3, 4, 8, 16    1, 13      1, 2, 3, 4, 6, 8, 12, 24*
- Let's write 3 common multiples of the following pairs of numbers from the smallest to the largest. Find the least common multiple for them.  
*Finding common multiples and least common multiples.*  
① (3, 7)      ② (12, 18)      ③ (10, 20)  
*21, 42, 63      36, 72, 108      20, 40, 60*
- Let's write all the common divisors of the following pairs of numbers. Find the highest common divisor for them.  
*Finding common divisors and the greatest common divisors.*  
① (9, 15)      ② (4, 11)      ③ (12, 24)  
*1, 3      1      1, 2, 3, 4, 6, 12*
- PMV bus A departs every 12 minutes and bus B departs every 8 minutes at 4 mile bus stop. Bus A and B both departed at 9 am. What is the next time that bus A and B will depart at the same time?  
*Solving problems by using common multiples or common divisors.*  
**After 72 minutes (1 hour 12 minutes) which is 10:12 am**
- Start with a sheet of graph paper that is 30 cm wide and 12 cm long. Cut out squares of the same size so that no paper is left over. How many of these squares can be cut out?  
*Solving problems by using common multiples or common divisors.*  
**10 of 6 cm side squares can be cut**
- Let's find the prime number that is bigger than 50 and closest to 50.  
*Understanding some numbers can be divided by only 1 and itself.*  
**53 (can be divided by only 1 and itself)**

$104 = \square \times \square$



## Lesson Flow

### 1 Complete the Exercise

- S** Solve all the exercises.
- T** Confirm students' answers.
- TN** **1** Identifying multiples and divisors
- 2** Finding common multiples and least common multiples.
- 3** Finding common divisors and greatest common divisors.

### 2 Solve the Problems

- S** Solve all the problems.
- T** Confirm students' answers.
- TN** **1** Finding multiples and divisors.
- 2** Finding common multiples and least common multiples.
- 3** Finding common divisors and the greatest common divisors.
- 4** and **5** Solving problems by using common multiples or common divisors
- 6** Understanding that some numbers can be divided by only 1 and itself.

### 3 Complete the Evaluation Test

- TN** Use the attached evaluation test to conduct assesment for your class after finishing all the exercises and problems as a seperate lesson.
- S** Complete the Evaluation Test.

End of Chapter Test:		Date:
Chapter 7: Multiples and Divisors	Name:	Score / 100

1. Answer the following questions.  
[4 x 20 marks = 80 marks]

(1) List 3 consecutive multiples of 8 from the smallest.

Answer:

(2) List 3 consecutive common multiples of 4 and 6 from the smallest.

Answer:

(3) List all the divisors of 36.

Answer:

(4) List all the common divisors of 18 and 24 from the smallest.

Answer:

2. Answer the following questions.  
[2 x 10 marks = 20 marks]

(1) For making a smallest square with rectangular papers of 5cm length and 8cm width only, find the side of the smallest square.

Answer:

(2) What is the multiple of 7 nearest to 100?

Answer:

**End of Chapter Test**

**Date:**

Chapter 7: Multiples and Divisors	Name:	Score / 100
--------------------------------------	-------	----------------

1. Answer the following questions.

[4 × 20 marks = 80 marks]

(1) List 3 consecutive multiples of 8 from the smallest.

Answer:

(2) List 3 consecutive common multiples of 4 and 6 from the smallest.

Answer:

(3) List all the divisors of 36.

Answer:

(4) List all the common divisors of 18 and 24 from the smallest.

Answer:

2. Answer the following questions.

[2 × 10 marks = 20 marks]

(1) For making a smallest square with the rectangular papers of 5 cm length and 8 cm width only, find the side of the smallest square.

Answer:

(2) What is the multiple of 7 nearest to 100?

Answer:

# Chapter 8 Fractions

## 1. Content Standard

5.1.1 Apply the process of addition and subtraction to add and subtract the fractions with different denominators.

## 2. Unit Objectives

- To deepen the understanding about fractions.
- To change whole number or decimal number to fraction and vice versa.
- To recognise that when multiplying or dividing both numerator and denominator by the same number the amount of fraction doesn't change.
- To recognise that the quotient of division of whole number can be expressed as a fraction.
- To understand how to compare the fraction with different denominators.

## 3. Teaching Overview

In this unit, students will expand their conception of fractions with the introduction of equivalent fractions.

### Equivalent Fractions :

There are infinite expressions of a fraction and that is by changing the denominator and the numerator of a fraction. Students will then know that there are always equivalent fractions for any fractions.

### Comparison of Fractions :

They will know that they can compare fractions by making the same denominators.

As they experience making denominators bigger by making its equivalent fractions, they also acquire the skill of canceling unconsciously.

### Fractions, Decimals and Whole Numbers :

They will learn that the result of a division can be expressed as a fraction.

Through doing many divisions, they will also find the relationship among fraction, decimal, and whole number and their correspondences.

## 4. Related Learning Contents

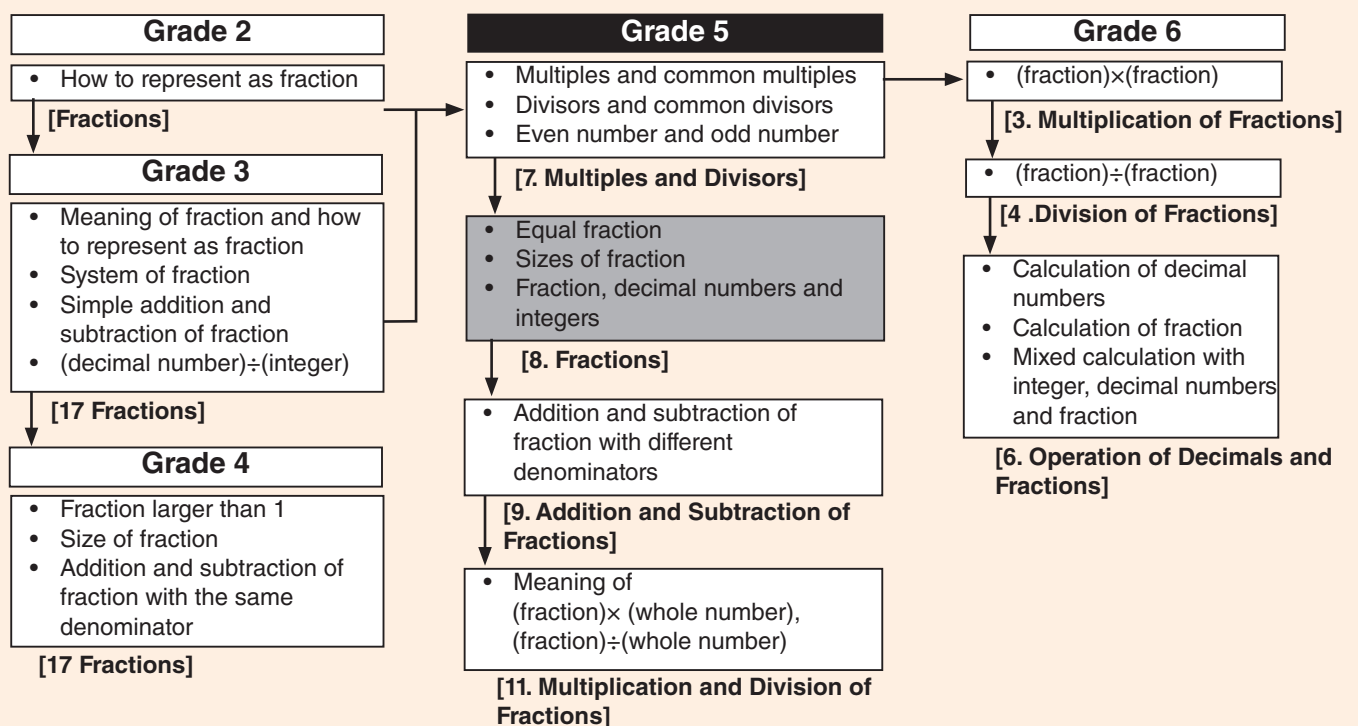

**Sub-unit Objectives**

- To understand that even the denominator or numerator are different, the same amount of fraction can be made.
- To understand that when multiplying or dividing both numerator and denominator by the same number the amount of fraction doesn't change.

**Lesson Objectives**

- To express a unit fraction as various fractions.
- To investigate the fractions which have the same amount of quantity.

**Prior Knowledge**

- Equivalent fractions using number lines (Grade 4)
- Fraction unit idea (Grade 4)
- Fractions equal to  $\frac{1}{2}$ ,  $\frac{1}{3}$  and  $\frac{3}{4}$  (Grade 4)

**Preparation**

- Fraction measuring container (Prepare fraction measuring container as seen in the textbook), juice (use water or other liquids if juice is not available)

**Assessment**

- Think about how same amount of juice can be represented in various fractions. **F**
- Compare and find the equivalent fraction using unit fraction idea. **F S**

**Teacher's Notes**

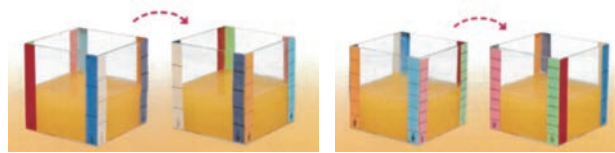

Students should know that the amount of juice as  $\frac{1}{2}$  L does not change. The unit fraction changes to different fractions with the same amount of juice. This leads to the clear understanding of making equivalent fraction for  $\frac{1}{2}$  L.

- Making equivalent fractions, the numerator and the denominator are multiplied by the same number.

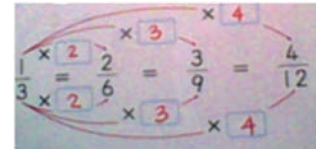

**8 Fractions**

▶ Let's pour some orange juice in a fraction measuring container.

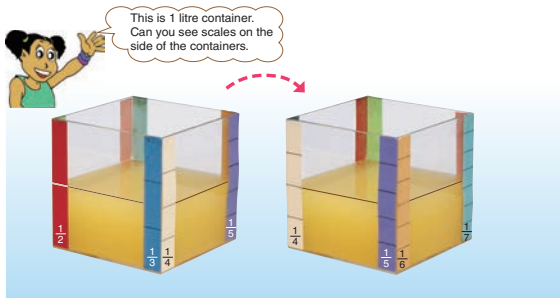

There is  $\frac{1}{2}$  L of juice in the fraction measuring container. If you draw dividing lines as shown below, how will the quantity be represented? Let's use fractions to represent the quantity of juice.

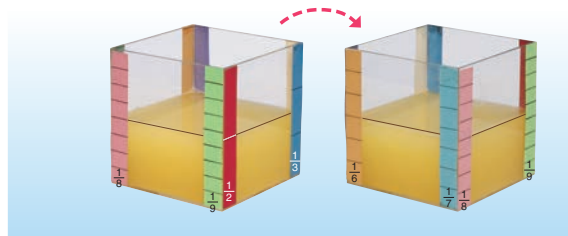
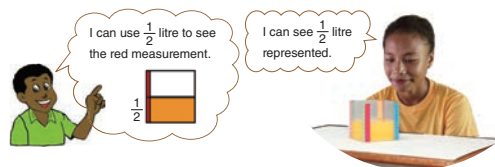
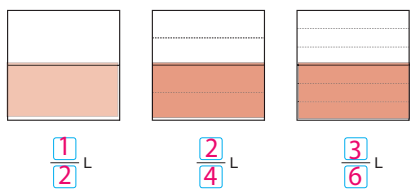

You can represent the same amount of juice in many different ways in fraction.

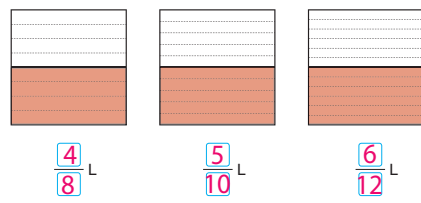

## Lesson Flow

### 1 Think about equal fraction when using the juice in the measuring container.

- T** Introduce the Main Task. (Refer to the BP)
- T/S** Read and understand the situation.
- T** Ask the students to observe the 1 L juice in the fraction measuring container and discuss about what they can see.
- S** Express that the juice measure  $\frac{1}{2}$  L can also be measured using other fraction containers.
- TN** Appreciate students' responses and their reasons to what they have observed.
- T** Confirm students' responses.
- T** Ask students to shade the portion and write the fraction in Litres.
- S** Represent the quantity of juice in fraction. ( $\frac{1}{2}, \frac{2}{4}, \frac{3}{6}, \frac{4}{8}, \frac{5}{10}$  and  $\frac{6}{12}$ )

### 2 1 Explore equivalence of fractions using the number line.

- T/S** Use the number line to explore the equivalence of fractions.

### 3 1 Find the fractions which are equivalent to $\frac{1}{2}$ and $\frac{1}{3}$ .

- T** Let the students use the equivalence of fractions on the number lines for 1 and 2.

- S** Write the equivalent fractions for  $\frac{1}{2}$  and  $\frac{1}{3}$  by filling in the box .

### 4 3 4 Find how many times the numerator and the denominator are multiplied by a number of the fraction $\frac{1}{2}$ and $\frac{1}{3}$ .

- S** Find and write the numbers which are multiplied to each denominator and the numerator of the fraction  $\frac{1}{2}$  and  $\frac{1}{3}$ .

### 5 Complete the Exercise

- S** Solve the selected exercises.
- T** Confirm students' answers.

### 6 Summary

- T** What have you learned in this lesson?
- S** Present ideas on what they have learned.
- T** Use students' ideas to confirm the important concepts of this lesson.

## Sample Blackboard Plan

Lesson 070 Sample Blackboard Plan is on page 153.

### 1 Equivalent Fractions

- 1 Let's explore the equivalence of fractions by using the number line.

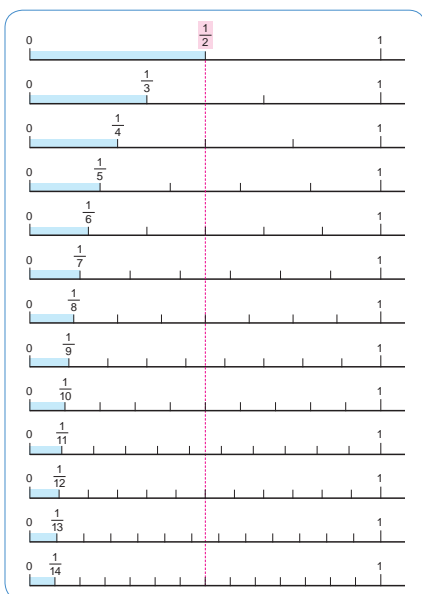

- 1 Let's find fractions, which are equivalent to  $\frac{1}{2}$ .

$$\frac{1}{2} = \frac{\square}{4} = \frac{\square}{6} = \frac{\square}{8} = \frac{5}{10} = \frac{6}{12} = \frac{\square}{14}$$

- 2 Let's find fractions, which are equivalent to  $\frac{1}{3}$ .

$$\frac{1}{3} = \frac{\square}{6} = \frac{3}{9} = \frac{\square}{12}$$

- 3 What numbers are multiplied to each denominator and numerator of the fraction  $\frac{1}{2}$  in problem 1?

$$\frac{1}{2} \times \frac{\square}{\square} = \frac{2}{4} \times \frac{\square}{\square} = \frac{3}{6} \times \frac{\square}{\square} = \frac{4}{8} \times \frac{\square}{\square} = \frac{5}{10} \times \frac{\square}{\square} = \frac{6}{12} \times \frac{\square}{\square}$$

- 4 What numbers are multiplied to each denominator and numerator of the fraction  $\frac{1}{3}$  in problem 2?

$$\frac{1}{3} \times \frac{\square}{\square} = \frac{2}{6} \times \frac{\square}{\square} = \frac{3}{9} \times \frac{\square}{\square} = \frac{4}{12} \times \frac{\square}{\square}$$

#### Exercise

Let's develop 4 fractions which are equivalent to  $\frac{1}{2}$ .

**Sub-unit Objectives**

- To understand how to compare fractions with different denominators.
- To understand how to make equivalent fractions.
- To understand how to reduce fractions.

**Lesson Objectives**

- Compare fractions with different denominators by changing their representations using the same denominator.
- To identify and understand the meaning of equivalent fraction.

**Prior Knowledge**

- Making equivalent fractions by multiplying the numerator and denominator with the same number

**Preparation**

- Chart of diagram representation for **1**

**Assessment**

- Think about how to compare fractions with different denominators by changing their representations using the same denominator. **F**
- Understand the meaning of equivalent fractions. **S**

**Teacher's Notes**

This lesson focuses on “How to compare fractions with different denominators”

Firstly, treat individual fraction to find the equivalent fraction by multiplying or dividing the numerator and the denominator with the same number.

$$\frac{4}{3} = \frac{4}{6}, \frac{6}{9} \text{ and } \frac{8}{12}$$

$$\frac{3}{4} = \frac{6}{8} \text{ and } \frac{9}{12}$$

Secondly, make comparisons to identify the same denominator from the equivalent fractions made.

$$\frac{2}{3} = \frac{4}{6}, \frac{6}{9} \text{ and } \frac{8}{12}$$

$$\frac{3}{4} = \frac{6}{8} \text{ and } \frac{9}{12}$$

Thirdly, change the fractions to the same denominator and compare.

$$\frac{2}{3} = \frac{8}{12} < \text{less or smaller than } \frac{3}{4} = \frac{9}{12}$$

**2 Comparison of Fractions**

▶ Let's compare the sizes of  $\frac{2}{4}$ ,  $\frac{2}{3}$  and  $\frac{3}{4}$ .



$\frac{2}{4}$  and  $\frac{3}{4}$  have same denominator so we can compare them.

How can we compare the sizes of  $\frac{2}{3}$  and  $\frac{3}{4}$ .



Let's think about how to compare the size of fractions with different denominators.

**1** Let's think about how to compare  $\frac{2}{3}$  and  $\frac{3}{4}$ .

**1** Let's represent  $\frac{2}{3}$  using various fractions.



**A** Let's represent  $\frac{2}{3}$  by  $\frac{1}{6}$ ,  $\frac{1}{9}$  and  $\frac{1}{12}$  as the units.

**B** What is the relationship between denominators and numerators of equivalent fractions?

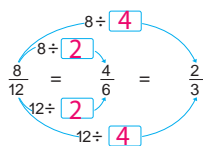
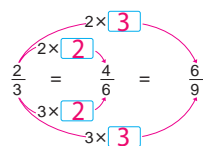

The size of fractions does not change even if the numerator and denominator are multiplied or divided by the same number.

$$\frac{\triangle}{\bullet} = \frac{\triangle \times \square}{\bullet \times \square} = \frac{\triangle \div \square}{\bullet \div \square}$$

110 = □ × □

**Page 111 of the textbook**

**2** Let's represent  $\frac{3}{4}$  by  $\frac{1}{8}$ ,  $\frac{1}{12}$  and  $\frac{1}{16}$  as the units.

$$\frac{3}{4} = \frac{3 \times 3}{4 \times 3} = \frac{9}{12}$$

The same fraction can be represented in many ways by changing the units.



**3** Let's compare  $\frac{2}{3}$  and  $\frac{3}{4}$  by changing their representation using the same denominator.

$$\frac{2}{3} = \frac{8}{12}, \frac{3}{4} = \frac{9}{12} \text{ therefore, } \frac{2}{3} < \frac{3}{4}$$



## Lesson Flow

**1** Review the previous lesson.

**2** Compare the sizes of  $\frac{2}{4}$ ,  $\frac{2}{3}$  and  $\frac{3}{4}$ .

**T** Which of these fractions can be compared easily?

**S** Express that  $\frac{2}{4}$  and  $\frac{3}{4}$  can be compared.

**T** Explain why they can be compared easily?

**S**  $\frac{2}{4}$  and  $\frac{3}{4}$  have the same denominator so we can compare them and realise that  $\frac{2}{3}$  and  $\frac{3}{4}$  are difficult to compare because they have different denominators.

**T** How can we compare  $\frac{2}{3}$  and  $\frac{3}{4}$ ?

**S** Present their ideas.

**T** Introduce the Main Task. (Refer to the BP)

**3** **1** Think about how to compare the size of fractions with different denominators.

**T** Emphasise that since  $\frac{2}{3}$  and  $\frac{3}{4}$  have different denominators, how can we compare them?

**S** **1** Observe the representation of  $\frac{2}{3}$  in various fractions using the fraction unit of  $\frac{1}{6}$ ,  $\frac{1}{9}$  and  $\frac{1}{12}$ .

**T** Let's represent  $\frac{2}{3}$  by units of  $\frac{1}{6}$ ,  $\frac{1}{9}$  and  $\frac{1}{12}$ . (Refer to diagram)

**S** **A** Identify  $\frac{2}{3}$  by fraction unit of  $\frac{1}{6}$  is  $\frac{4}{6}$ ,  $\frac{1}{9}$  is  $\frac{6}{9}$  and  $\frac{1}{12}$  is  $\frac{8}{12}$ .

**TN** The quantity remains the same however the fraction (numerator and denominator) changes to make other equal fractions which are equivalent fractions to  $\frac{2}{3}$ .

**4** **1** **B** Finding the relationship between the numerator and denominator of the equivalent fractions.

**S** Write the correct answers by filling in the box  to find the relationship between the denominators and numerators of equivalent fractions.

**5** Important Point

**T/S** Explain the important point in the box .

**6** **2** Represent  $\frac{3}{4}$  by using unit fraction of  $\frac{1}{8}$ ,  $\frac{1}{12}$  and  $\frac{1}{16}$ .

**S** Write the correct answers by filling in the box  by multiplying the numerator and the denominator with the same number.

**7** **3** Comparing  $\frac{2}{3}$  and  $\frac{3}{4}$  by changing their representations using the same denominator.

**T** Ask the students to look back when finding the equivalent fractions for  $\frac{2}{3}$  and  $\frac{3}{4}$ .

**S** Identify the equivalent fractions for  $\frac{2}{3}$  and  $\frac{3}{4}$ .

$$\frac{2}{3} = \frac{8}{12}$$

$$\frac{3}{4} = \frac{9}{12} \text{ and therefore, } \frac{2}{3} < \frac{3}{4}.$$

**T** What is the same denominator to find the equivalent fraction for  $\frac{2}{3}$  and  $\frac{3}{4}$ ?

**TN** In order to find the same denominator, we use the idea of finding the least common multiple.

**S** Find the same denominator as 12 and compare the two fractions by filling in the box .

**8** Summary

**T** What have you learned in this lesson?

**S** Present ideas on what they have learned.

**T** Use students' ideas to confirm the important concepts of this lesson.

## Sample Blackboard Plan

Date: \_\_\_\_\_ Chapter: 8 Fractions Sub-chapter: 2. Comparison of Fractions Lesson Number: 1/4

MT: Compare size of fractions with different denominators

**2** Comparison of Fractions

▶▶ Let's compare the sizes of  $\frac{2}{4}$ ,  $\frac{2}{3}$  and  $\frac{3}{4}$ .

MT: Introduce the main task here.

**1** Let's think about how to compare  $\frac{2}{3}$  and  $\frac{3}{4}$ .

**1** **A** Equivalent fractions of  $\frac{2}{3}$  using units of  $\frac{1}{6}$ ,  $\frac{1}{9}$  and  $\frac{1}{12}$



**B** Relationship between the denominators and numerators of equivalent fractions.



The size of fractions does not change even if the numerator and denominator are multiplied or divided by the same number.  $\frac{2}{3} = \frac{2 \times 2}{3 \times 2} = \frac{4}{6}$ ,  $\frac{2}{3} = \frac{2 \times 3}{3 \times 3} = \frac{6}{9}$ ,  $\frac{2}{3} = \frac{2 \times 4}{3 \times 4} = \frac{8}{12}$

**2** Representing Equivalent fractions  $\frac{3}{4}$  by  $\frac{1}{8}$ ,  $\frac{1}{12}$  and  $\frac{1}{16}$

$\frac{3}{4} = \frac{3 \times 3}{4 \times 3} = \frac{9}{12}$

**3** Let's compare  $\frac{2}{3}$  and  $\frac{3}{4}$  by changing their representation using the same denominator.

$\frac{2}{3} = \frac{2 \times 4}{3 \times 4} = \frac{8}{12}$   
 $\frac{3}{4} = \frac{3 \times 3}{4 \times 3} = \frac{9}{12}$

$\frac{2}{3} = \frac{8}{12}$ ,  $\frac{3}{4} = \frac{9}{12}$  therefore  $\frac{2}{3} < \frac{3}{4}$

**Summary**  
The size of fractions does not change even if the numerator and denominator are multiplied or divided by the same number.

### Lesson Objective

- Convert the fractions with different denominators to a common denominator and understand the meaning of equivalent fractions.

### Prior Knowledge

- The size of fractions does not change even if the numerator and the denominator are multiplied or divided by the same number.
- Comparing the fractions with different denominators when converting the different denominators to the same denominator.

### Preparation

- Chart of equivalent fractions

### Assessment

- Think about how to compare the fractions with different denominators to same denominators to make equivalent fraction and compare. **F S**

### Teacher's Notes

In this lesson the main idea is to find the common denominator for the fractions with different denominators and make comparison. The fractions with different denominators can be compared when the different denominators are made the same.

- Change the given fractions to equivalent fractions to find the common denominator.

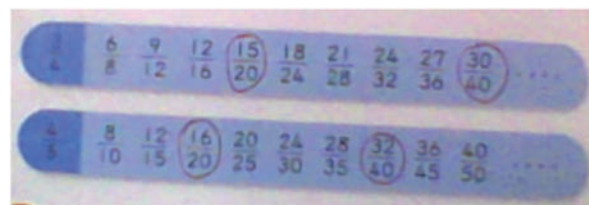

The common denominators are 20 and 40. Comparing using 20 and 40 as common denominators  $\frac{3}{4}$  is smaller than  $\frac{4}{5}$ .

- To find the common denominator the denominators of fractions to be compared are multiplied.  
 $\frac{2}{3}$  and  $\frac{4}{7}$  ( $3 \times 7$  or  $7 \times 3 = 21$  becomes the common denominator.)

The common denominator is 21 therefore  $\frac{2}{3}$  is greater than  $\frac{4}{7}$

$$\frac{4 \times 3 = 12}{7 \times 3 = 21}$$

$$\frac{2 \times 7 = 14}{3 \times 7 = 21}$$

The numerators and denominators are multiplied by the same number to make equivalent fractions.

#### Common Denominators

- Compare  $\frac{3}{4}$  and  $\frac{4}{5}$  by changing them to equivalent fractions with a common denominator. Which denominators can the two fractions below be compared with? Circle them.

$$\frac{3}{4} \quad \frac{6}{8} \quad \frac{9}{12} \quad \frac{12}{16} \quad \frac{15}{20} \quad \frac{18}{24} \quad \frac{21}{28} \quad \frac{24}{32} \quad \frac{27}{36} \quad \frac{30}{40} \quad \dots$$

$$\frac{4}{5} \quad \frac{8}{10} \quad \frac{12}{15} \quad \frac{16}{20} \quad \frac{20}{25} \quad \frac{24}{30} \quad \frac{28}{35} \quad \frac{32}{40} \quad \frac{36}{45} \quad \frac{40}{50} \quad \dots$$



Fractions with different denominators can be compared by changing them to fractions with the same denominator.



Finding a common denominator means changing fractions with different denominators into equivalent fractions with the same denominator.

- Compare  $\frac{2}{3}$  and  $\frac{4}{7}$  by changing them into fractions with common denominators.

$$\frac{2}{3} = \frac{14}{21}, \quad \frac{4}{7} = \frac{12}{21}, \quad \text{then } \frac{2}{3} > \frac{4}{7}$$



We can find the common denominator if we multiply denominators of fractions which we would like to compare with.



## Lesson Flow

**1** Review the previous lesson.

**2** **2** Think about how to compare  $\frac{3}{4}$  and  $\frac{4}{5}$ .

**T** Introduce the Main Task. (Refer to the BP)

**T/S** Read and understand the situation.

**T** How can we compare  $\frac{3}{4}$  and  $\frac{4}{5}$ ?

**S** By changing the representations using the same denominator from previous lesson.

**T** Confirm students' responses.

**TN** Students realise and understand that to compare  $\frac{3}{4}$  and  $\frac{4}{5}$ , the fractions have to be changed to equivalent fractions with a common denominator.

**T** Ask students to observe the equivalent fraction for  $\frac{3}{4}$  and  $\frac{4}{5}$  and circle the denominators that can be used to compare the two fractions.

**S**  $\frac{5}{4}, \frac{15}{20}, \frac{30}{40}$   
 $\frac{5}{4}, \frac{16}{20}, \frac{32}{40}$

**TN** There are two fractions with common denominators, however, we can compare using the first fractions with a common denominator.

**3** Important Points.

**T/S** Explain the important points in the boxes   and  .

**4** **3** Compare  $\frac{2}{3}$  and  $\frac{4}{7}$  by changing them into fractions to common denominators.

**S** Fill in the box   with equivalent fraction for  $\frac{2}{3}$  and  $\frac{4}{7}$  by multiplying the denominators then compare with the inequality sign.

$$\frac{2}{3} \begin{matrix} \times 7 \\ \times 7 \end{matrix} \frac{\quad}{21} \quad \frac{4}{7} \begin{matrix} \times 3 \\ \times 3 \end{matrix} \frac{\quad}{21} \quad \longrightarrow \quad \text{Compare } \frac{2}{3} \quad \square \quad \frac{4}{7}$$

**TN** We can find the common denominator of  $\frac{2}{3}$  and  $\frac{4}{7}$  by multiplying the denominators of both fractions that are compared.

**5** Summary

**T** What have you learned in this lesson?

**S** Present ideas on what they have learned.

**T** Use students' ideas to confirm the important concepts of this lesson.

## Sample Blackboard Plan

Date: Chapter:8 Fractions      Sub- chapter:2. Comparison of Fractions      Lesson Number: 2/4

**MT:** Compare fractions with different denominators by converting them to fractions with common denominators.

**MT:** Introduce the main task here.

**Common Denominators**

**2** Compare  $\frac{3}{4}$  and  $\frac{4}{5}$  by changing them to equivalent fractions with a common denominator.

**Equivalent fractions for  $\frac{3}{4}$**

$\frac{3}{4} : \frac{6}{8}, \frac{9}{12}, \frac{12}{16}, \frac{15}{20}, \frac{18}{24}, \frac{21}{28}, \frac{24}{32}, \frac{27}{36}, \frac{30}{40}$

**Equivalent fractions for  $\frac{4}{5}$**

$\frac{4}{5} : \frac{8}{10}, \frac{12}{15}, \frac{16}{20}, \frac{20}{25}, \frac{24}{30}, \frac{28}{35}, \frac{32}{40}, \frac{36}{45}, \frac{40}{50}$

**3** Compare  $\frac{2}{3}$  and  $\frac{4}{7}$  by changing them into fractions with common denominators.

$\frac{2}{3} = \frac{14}{21}, \frac{4}{7} = \frac{12}{21}$ , then,  $\frac{2}{3} > \frac{4}{7}$

**Summary**

Fractions with different denominators can be compared by changing them to fractions with common denominators and then calculate.

Fractions with different denominators can be compared by changing them to fractions with the same denominator.

Finding a common denominator means changing fractions with different denominators into equivalent fractions with the same denominator.

Lesson Objectives

- Identify and find the least common multiples as common denominators in equivalent fractions to compare sizes of given fractions.
- Identify how to compare mixed fractions and improper fractions using a common denominator.

Prior Knowledge

- Comparing the fractions with different denominators when converting the different denominators to the same denominator.
- Finding a common denominator means changing fractions with different denominators into equivalent fractions with the same denominator.

Preparation

- Chart of Mero's and Yamo's Ideas

Assessment

- Think about how to find the least common multiples as common denominators. **F**
- Compare mixed fractions and improper fractions using a common denominator. **F S**

Teacher's Notes

To find the common denominator for two fractions that are compared, one idea discussed in this lesson is to multiply the two denominators to get a common denominator as shown below:

$$\frac{4}{5} = \frac{4 \times \square}{5 \times \square} = \frac{18}{30}$$

$$\frac{2}{3} = \frac{2 \times \square}{3 \times \square} = \frac{10}{30}$$

The other idea is to choose the least common multiple of 5 and 3 as the common denominator.

$$\frac{4}{5} = \frac{4 \times \square}{5 \times \square} = \frac{12}{15}$$

$$\frac{2}{3} = \frac{2 \times \square}{3 \times \square} = \frac{10}{15}$$

Finding Common Denominators

4 Let's find the common denominator for  $\frac{5}{6}$  and  $\frac{7}{8}$ .



Mero's Idea

Multiply the two denominators to get the common denominator.

$$\frac{5}{6} = \frac{5 \times 8}{6 \times 8} = \frac{40}{48}$$

$$\frac{7}{8} = \frac{7 \times 6}{8 \times 6} = \frac{42}{48}$$



Yamo's Idea

Choose 24, the least common multiple of 6 and 8, as the common denominator.

$$\frac{5}{6} = \frac{5 \times 4}{6 \times 4} = \frac{20}{24}$$

$$\frac{7}{8} = \frac{7 \times 3}{8 \times 3} = \frac{21}{24}$$

5 Usually, you should choose the least common multiple as the common denominator to use as the smallest common denominator.

Let's compare the following fractions using common denominators.

1  $\frac{1}{4}$  and  $\frac{2}{7}$  The least common multiple of 4 and 7 is **28**.

$$\frac{1}{4} = \frac{1 \times 7}{4 \times 7} = \frac{7}{28}, \frac{2}{7} = \frac{2 \times 4}{7 \times 4} = \frac{8}{28}, \text{ therefore } \frac{1}{4} < \frac{2}{7}$$

2  $\frac{1}{3}$  and  $\frac{2}{9}$  The least common multiple of 3 and 9 is **9**.

$$\frac{1}{3} = \frac{1 \times 3}{3 \times 3} = \frac{3}{9}, \text{ therefore } \frac{1}{3} > \frac{2}{9}$$

6 Let's compare  $1\frac{3}{4}$  and  $\frac{11}{6}$  using a common denominator.



I changed mixed fraction to improper fraction.



I changed improper fraction to mixed fraction.

## Lesson Flow

**1** Review the previous lesson.

**2** **4** Find the common denominator for  $\frac{5}{6}$  and  $\frac{7}{8}$ .

**T** Introduce the Main Task. (Refer to the BP)

**TN** In the other lessons, fractions with different denominators were converted into equivalent fractions with the same denominator to compare.

**T** Ask students to find the common denominator for  $\frac{5}{6}$  and  $\frac{7}{8}$ .

**S** Present their ideas with reasons.

**T** Let the students discuss and explain the ideas used by Mero and Yamo.

**S** Observe the two ideas and fill in the box  and share their explanations.

**TN** Mero's Idea - He multiplied the two denominators to get the common denominator.

$6 \times 8$  and  $8 \times 6$  and both gives the common denominator 48.

Yamo's Idea - She chose the least common multiple of 6 & 8 as the common denominator which is 24.

**S** Identify the least common multiple which is usually used as the lowest common denominator to compare fractions with different denominators.

**3** **5** Find the common denominator for fractions in **1** and **2**.

**S** Compare the following fractions using common denominators for **1** and **2**.

**S** Complete the two activities.

**T** Confirm students' answers.

**4** **6** Compare mixed fraction and improper fraction using a common denominator.

**T** Compare  $1\frac{3}{4}$  and  $\frac{11}{6}$  using a common denominator.

**TN** Use the hints in the bubbles to find the common denominator.

**S** Change the fractions to either mixed fractions or improper fractions to find the common denominators for both fractions.

**5** Summary

**T** What have you learned in this lesson?

**S** Present ideas on what they have learned.

**T** Use students' ideas to confirm the important concepts of this lesson.

## Sample Blackboard Plan

Date:	Chapter:8 Fractions	Sub- chapter:2. Comparison of Fractions	Lesson Number: 3/4
-------	---------------------	---	--------------------

**MT:** Let's think about how to draw a round shape

**4** Finding Common Denominators

**4** Let's find the common denominator for  $\frac{5}{6}$  and  $\frac{7}{8}$ .

**MT:** Introduce the main task here.

**5** Let's compare the following fractions using common denominators.

**1**  $(\frac{1}{4}, \frac{2}{7}) = \frac{1}{4} = 1 \times \frac{7}{4} \times 7 = \frac{7}{28}$ ,  $\frac{2}{7} = 2 \times \frac{4}{7} \times 4 = \frac{8}{28}$

LCM in the multiples of 4 and 7 is **28**.

**2** Therefore,  $\frac{1}{4} < \frac{2}{7}$

$(\frac{1}{3}, \frac{2}{9}) = \frac{1}{3} = 1 \times \frac{3}{3} \times 3 = \frac{3}{9}$

LCM in the multiples of 3 and 9 is **9**.

$\frac{3}{9} > \frac{2}{9}$  Therefore,  $\frac{1}{3} > \frac{2}{9}$

**6** Let's compare  $1\frac{3}{4}$  and  $\frac{11}{6}$  using a common denominator.

**1.** Change to common denominator (12).

$\frac{13}{4} = \frac{7}{4}$       $\frac{7}{4} = 7 \times \frac{3}{4} \times 3 = \frac{21}{12}$   
and  $\frac{11}{6} = 11 \times \frac{2}{6} \times 2 = \frac{22}{12}$

**2.** Change to mixed fraction  $\frac{11}{6} = \frac{15}{6}$ .  
1 is same and found in both fractions ( $1\frac{3}{4}$  and  $1\frac{5}{6}$ ), therefore compare the proper fractions  $\frac{3}{4}$  and  $\frac{5}{6}$

$\frac{3}{4} = 3 \times \frac{3}{4} \times 3 = \frac{9}{12}$       $\frac{5}{6} = 5 \times \frac{2}{6} \times 2 = \frac{10}{12}$

**Summary**  
Finding a common denominator for two fractions can be calculated by:

- Multiplying the two denominators to get a common denominator.
- Change mixed fraction to improper fraction or improper fraction to mixed fraction.

**Lesson Objectives**

- Define and understand the meaning of reduction of fractions and how to reduce fraction.
- Reduce given fractions by finding and using the Greatest Common Divisor.

**Prior Knowledge**

- Meaning of making equivalent fraction and comparing fractions using equivalent fractions.
- How to find the common denominator using least common multiple or multiplying the two denominators in given fractions.

**Preparation**

- Chart of Important Point

**Assessment**

- Define and understand the meaning of reduction of fraction. **F**
- Explain how to reduce the fractions using the Greatest Common Divisor. **F S**
- Solve the exercise correctly. **S**

**Teacher's Notes**

To find Equivalent fractions with the common denominator for comparison, the numerator and denominator are multiplied with the same number that increases the numerators and

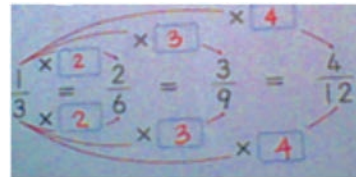

denominators making them become bigger fractions.

In Reduction of Fraction the numerator and denominator are divided by a number bigger, so the numerator or denominator can be divided with the same common factor by making the denominator as small as possible.

$$\frac{24}{36} \xrightarrow{\div 2} \frac{12}{18} \xrightarrow{\div 2} \frac{6}{9} \xrightarrow{\div 3} \frac{2}{3}$$

**Reducing Fractions**

- 7** Lisa and Joy are looking for fractions that are equivalent to  $\frac{24}{36}$  and with denominators and numerators smaller than 36 and 24.

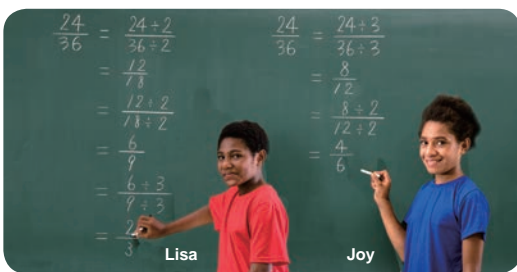

- 1 What rule of fraction are they using?
- 2 Lisa and Joy got different fractions. Explain their reasons.

**Because**

It is a word used to explain, by stating the conclusion first and then explaining why by showing a reason.

\* ○○○ is because △△△△.

For example: We reduce fractions **because** it makes calculation easier.



Reducing a fraction means dividing the numerator and denominator by a common divisor to make a simpler fraction.

When we reduce a fraction, we usually divide until we get the smallest numerator and denominator.

- 8** Steven and Alex reduced  $\frac{12}{18}$ . Let's explain their ideas.



- 1 What are the similarities in their ideas?
- 2 What are the differences between their ideas?



When you reduce a fraction, use the greatest common divisor to reduce the denominator and numerator, just like Alex did in **8**.

**Exercise**

- 1 Let's reduce these fractions to a common denominator and fill in the  with inequality signs.
  - ①  $\frac{2}{3} < \frac{4}{5}$
  - ②  $\frac{1}{2} > \frac{3}{8}$
  - ③  $\frac{5}{6} < \frac{8}{9}$
  - ④  $\frac{7}{12} < \frac{5}{8}$
- 2 Let's reduce these fractions.
  - ①  $\frac{8}{10} = \frac{4}{5}$
  - ②  $\frac{3}{21} = \frac{1}{7}$
  - ③  $\frac{16}{20} = \frac{4}{5}$
  - ④  $\frac{18}{24} = \frac{3}{4}$

## Lesson Flow

**1** Review the previous lesson.

**2** **7** Think about how to reduce the fraction  $\frac{24}{36}$

**T/S** Read and understand the situation.

**T** Ask the students to think of how to get  $\frac{24}{36}$  back to a smaller numerator and denominator by referring to Lisa's and Joy's blackboard work.

**S** Observe Lisa and Joy's blackboard work and discuss **1** and **2**.

Possible answers:

**1** They are dividing by the same number in which the amount doesn't change.

**2** They have different fractions because Lisa is dividing by 2, then by 2 and by 3 while Joy is dividing by 3 and then by 2.

**T** Pose guided questions for students to identify that to get bigger fraction down to smaller fraction division operation is applied and so the numerator or denominator can be divided with the same common number by making the denominator as small as possible. It is called reducing of fractions.

**T** Introduce the Main Task. (Refer to the BP)

**3** Important Point

**T/S** Explain the important point in the box  

**4** **8** Think about how to reduce the fraction  $\frac{12}{18}$

**T** Ask students to observe Steven's and Alex's board presentations and discuss what they can find from the two presentations by answering **1** and **2**.

**S** Possible answers are: the similarity is they are dividing the same number to get  $\frac{2}{3}$  and the difference is Steven is doing two calculations  $\div$  by 2 and then  $\div$  by 3 while Alex is doing only one calculation  $\div$  by 6.

**5** Important Point

**T/S** Explain the important point in the box  

**6** Complete the Exercise

**S** Solve the selected exercises.

**T** Confirm students' answers.

**7** Summary

**T** What have you learned in this lesson?

**S** Present ideas on what they have learned.

**T** Use students' ideas to confirm the important concepts of this lesson.

## Sample Blackboard Plan

Date: Chapter:8 Fractions
Sub- chapter:2. Comparison of Fractions
Lesson Number: 4/4

MT: To understand the meaning of reducing a fraction and how to reduce it.

### Reducing Fractions

**7** How to get equivalent fractions smaller than  $\frac{24}{36}$ .

Complete **1** and **2**.

$24/36 = 24 \div 2/36 \div 2 = 12/18$   
 $24/36 = 24 \div 12/36 \div 12 = 2/3$

$24/36 = 24 \div 3/36 \div 3 = 8/12$   
 $24/36 = 24 \div 6/36 \div 6 = 4 \div 2/6 \div 2 = 2/3$

$24/36 = 24 \div 4/36 \div 4 = 6/9$

$24/36 = 24 \div 6/36 \div 6 = 4/6$       $2/3$  is the simplified fraction.

Reducing a fraction means dividing the numerator and denominator by a common divisor to make a simpler fraction.

**8** Steven and Alex reduced **1** and **2**. Let's explain their ideas in

$\begin{array}{r} 2 \\ 6 \\ 9 \\ 3 \end{array} \Big| \frac{12}{18} = \frac{2}{3}$

$\begin{array}{r} 2 \\ 3 \end{array} \Big| \frac{12}{18} = \frac{2}{3}$

$\div$  by 2 and then  $\div$  by 3

$\div$  by greatest common divisor 6

When you reduce a fraction, use the greatest common divisor to the denominator and numerator to reduce it at step one, just like Alex did in problem **1**.

EXERCISE: refer to the text book.

**Summary**  
 When reducing a fraction to make it simpler, use the greatest common divisor to divide the numerator and denominator to reduce it.

MT: Introduce the main task here.

**Sub-unit Objectives**

- To think about how to express quotient by not using the whole number and the decimal number.
- To understand the relationship among fractions, decimal numbers and whole numbers.
- To change fractions to decimals, fraction to whole numbers and vice versa.

**Lesson Objective**

- To think about how to express the amount when 2 L is divided into 3 students. ( $2 \div 3$ )

**Prior Knowledge**

- Division of whole numbers and decimal numbers (Grade 4)

**Preparation**

- 2 L milk or other available liquid of 2 L

**Assessment**

- Think about how to express the quotient of  $2 \div 3$ .  
**F**
- Understand how to express the quotient of  $2 \div 3$ .  
**S**

**Teacher's Notes**

Refer to Page 151

**1 Fractions, Decimals and Whole Numbers**

**Quotients and Fractions**

- 1** When we divide 2 L milk amongst  students equally, how many litres of milk will each student receive?  
 $2 \div \square$



- 1** Enter the numbers from 1 to 5 in the  and calculate the answers.  
 $2 \div \square, 2 \div \square, 2 \div \square, 2 \div \square, 2 \div \square$   
 $= 2 \quad = 1 \quad = 0.67 \quad = 0.5 \quad = 0.4$

- 2** Divide the above expressions into 3 groups based on the answers.
- A** Answers that are whole numbers.  
(  $2 \div 1 \quad 2 \div 2$  )
- B** Answers that are expressed exactly as decimal numbers.  
(  $2 \div 4$  )
- C** Answers that are not expressed exactly as decimal numbers.  
(  $2 \div 3 \quad 2 \div 5$  )
- $2 \div 3$  is 0.666..., so this cannot be expressed exactly as a decimal number because there is no end.

- 3** When 2 L is divided equally amongst 3 students.

- A** Colour the part for one student in the diagram.
- B** How many L will each student receive?

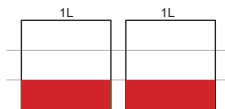

Let's see how to express the quotient of a division problem when it cannot be expressed exactly as a decimal number.

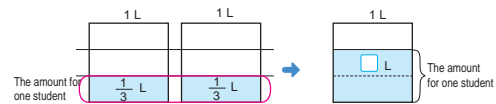

The amount for one student when 1 L is divided into 3 equal parts...  $\frac{1}{3}$  L.  
The amount for one student when 2 L is divided into 3 equal parts...  $\frac{2}{3}$  L.

I used  $\frac{1}{3}$  L from the first 1 L container and  $\frac{1}{3}$  L from the second 1 L container to fill up the empty container.

$$2 \div 3 = \frac{2}{3}$$

- 2** Let's find the length of one section when 1 m, 2 m and 3 m string is divided into 4 equal parts?

- 1** Let's write mathematical expressions for 1 m, 2 m and 3 m strings.
- 2** Let's find the answers based on a 1 m string?

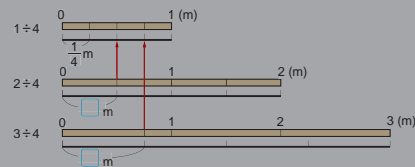

The quotient of a division problem in which a whole number is divided by another whole number can be expressed as a fraction.

The quotient can be expressed precisely as a fraction.

**Exercise**

Let's represent the quotient using a fraction.

- ①  $1 \div 6$     ②  $5 \div 8$     ③  $4 \div 3$     ④  $9 \div 7$

## Lesson Flow

### 1 Think about how many L each student will receive when 2 L is divided among several students.

**T** Ask the students to have a look at the 2 L of milk or any form of liquid however it must be 2 L and pose the question to the students.

How many litres will each student receive when this 2 L of milk or any form of liquid is divided equally among 1 student, 2 students, 3 students, 4 students and 5 students?

**S** Think of the question and think about the answer.

**T** Ask the students to turn to page 114 and read **1**. Ask the students to do **1** and **2**.

**S** Think about the situation and use the textbook to calculate and answers for **1** and **2**.

### 2 How to express $2 \div 3$

**T** Have students to understand that  $2 \div 3$  is 0.6666(recurring)

**S** Understand that  $2 \div 3$  is a decimal quotient that is recurring.

**T** **3** Ask the students to do **A** and **B**.

**S** Answer by **A** - colouring 1 part for 1 child.  
**B** - identify that 1 child will get  $\frac{2}{3}$  L.

**T** Introduce the Main Task. (Refer to the BP)

### 3 How to express the quotient of a division problem when it cannot be expressed exactly as a decimal number.

**T** Move on to page 117 and explain the diagram representation.

**S** Fill in the box , identify and express the quotient of the division problem  $2 \div 3$  to show that it cannot be expressed exactly as a decimal number.

### 4 Summary

**TN** Similar to previous lesson summary flow

#### • Teacher's Notes •

$2 \div 1 = 2$	}	Whole Number answers
$2 \div 2 = 1$		
$2 \div 4 = 0.5$	}	Exactly Decimal Number answers
$2 \div 5 = 0.4$		
$2 \div 3 = 0.666\dots$	→	Not Exactly Decimal Number answers because there is no end (recurring).

How to express the quotient of a division problem when it cannot be expressed exactly as a decimal number.

$2 \div 3$

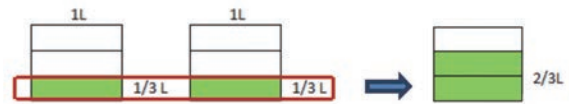

From 1 L it is known per student will receive  $\frac{1}{3}$  L so adding another 1 L makes it 2 L.  $2 \text{ L} \div 3$  is equal to  $\frac{2}{3}$  L per student.

## Sample Blackboard Plan

Date: \_\_\_\_\_ Chapter:8 Fractions Sub- chapter:3. Fractions, Decimals and Whole Numbers Lesson Number: 1/5

**MT: Expressing the quotient of  $2/3$  when it cannot be expressed exactly as a decimal number.**

**MT:** Introduce the main task here

**1 Fractions, Decimals and Whole Numbers**

Quotients and Fractions

**1** When we divide 2 of 1 L milk among  children equally, how many liters will each child receive?  
 $2 \div \square$

Let's solve activity **1** and **2** together.

**1**  $2 \div 1 = 2, 2 \div 2 = 1, 2 \div 3 = 0.666\dots, 2 \div 4 = 0.5, 2 \div 5 = 0.4$

**2** Answers that are whole numbers :  
 $2 \div 1$  and  $2 \div 2$   
Answers expressed exactly as decimal numbers:  
 $2 \div 4$  and  $2 \div 5$   
Answers not expressed exactly as decimal numbers:  
 $2 \div 3$

When 2 L is divided equally among 3 children.

**A** Colour the part for one child in the diagram:

**B** How many liters will each child receive ?

The amount for one child when 1L is divided into equal parts is  $\frac{1}{3}$  L.  
The amount for one child when 2L is divided into 3 equal parts is  $\frac{2}{3}$  L.  $2 \div 3 = \frac{2}{3}$

**Summary**  
When the quotients (answers) cannot be expressed as decimal number it can be as a fraction.

P 1

**Lesson Objective**

- To identify and understand that the quotient of division of whole numbers is always expressed as a fraction.

**Prior Knowledge**

- How to express the quotient of a division problem when it cannot be expressed exactly as a decimal number.
- Divided 2 L ÷ 3 is  $\frac{2}{3}$  L     $2 \div 3 = \frac{2}{3}$

**Preparation**

- Tape diagram for **2** **2**

**Assessment**

- Understand that the quotient of division problems can be expressed as a fraction. **F S**
- Solve the exercise correctly. **S**

**Teacher's Notes**

In this lesson, the answers to  $1 \div 4$ ,  $2 \div 4$  and  $3 \div 4$  can also be expressed exactly as decimal numbers. However, the focus is on the length of one section for the tape diagram therefore, answers should be expressed as fraction.

Encourage the students to write answers in fractions and not decimal numbers.

**Lesson Flow**

- 1** Review previous lesson.
- 2** **2** Think about how to express one section when 3 m is divided into 4 equal parts.
  - T** Revise  $2 \div 3$  by posing questions to students to check their understanding and mathematical thinking.
  - S** Respond to teacher's questions.
  - T** Read the question in **2** How many metres.
  - S** Think about how to express one section when 3 m is divided into 4 equal parts and write a mathematical expression **1**.
  - T** Introduce the Main Task. (Refer to the BP)

The amount for one student when 1 L is divided into 3 equal parts...  $\frac{1}{3}$  L.

The amount for one student when 2 L is divided into 3 equal parts...  $\frac{2}{3}$  L.

$2 \div 3 = \frac{2}{3}$

I used  $\frac{1}{3}$  L from the first 1 L container and  $\frac{1}{3}$  L from the second 1 L container to fill up the empty container.

- Let's find the length of one section when 1 m, 2 m and 3 m string is divided into 4 equal parts?
- Let's write mathematical expressions for 1 m, 2 m and 3 m strings.
- Let's find the answers based on a 1 m string?  $\frac{3}{4}$

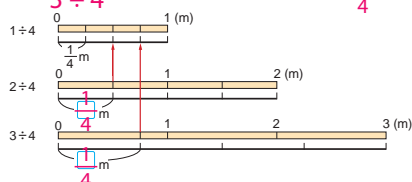

The quotient of a division problem in which a whole number is divided by another whole number can be expressed as a fraction.

$\frac{a}{b} = \frac{a}{b}$

The quotient can be expressed precisely as a fraction.

**Exercise**

Let's represent the quotient using a fraction.

- $1 \div 6 = \frac{1}{6}$
- $5 \div 8 = \frac{5}{8}$
- $4 \div 3 = \frac{4}{3}$
- $9 \div 7 = \frac{9}{7}$



## Lesson Flow

**3** **2** Use the tape diagram to express  $3 \div 4$  as a fraction.

**T** Ask the students to use the tape diagram and discuss with friends to find and fill in the box .

**S** Use the tape diagram to find the length of one section in the expression  $3 \div 4$  and fill in the box .

**T** Allow the students to present their ideas and answers.

**T** Introduce the Main Task. (Refer to the BP)

**5** Complete the Exercise

**S** Solve the exercises.

**T** Confirm students' answers.

**6** Summary

**T** What have you learned in this lesson?

**S** Present ideas on what they have learned.

**T** Use students' ideas to confirm the important concepts of this lesson.

**4** Important Point

**T/S** Explain the important point in the box .

### Sample Blackboard Plan (Lesson 70)

Date: \_\_\_\_\_ Chapter: 8 Fractions Sub- chapter: 1. Equivalent Fractions. Lesson Number: 1/1

**MT:** To investigate and express a unit fraction as various fractions using diagram representations.

**MT:** Introduce the main task here.

▶▶ Let's pour some orange juice in a fraction measuring container. There is  $\frac{1}{2}$  L of juice in a fraction measuring container.

Let's use fractions to represent the quantity of juice.

- $\frac{1}{2}$  L in many different ways.
- $\frac{2}{4}$ L,  $\frac{3}{6}$ L,  $\frac{4}{8}$ L,  $\frac{5}{10}$ L.....
- The same amount of juice can be represented in many different ways in fractions.

**1** **Equivalent Fractions**

**1**  $\frac{1}{2}$  is equivalent to  $\frac{2}{4}$ ,  $\frac{3}{6}$ ,  $\frac{4}{8}$ ,  $\frac{5}{10}$ ,  $\frac{6}{12}$ .....

**2**  $\frac{1}{3}$  is equivalent to  $\frac{2}{6}$ ,  $\frac{3}{9}$ ,  $\frac{4}{12}$ ...

**Exercise**  
Complete the exercise

**Summary**

- To make equivalent fractions the numerator and the denominator are multiplied by the same number.
- In equivalent fractions the amount does not change it remains the same while the fraction changes.

P 151

### Sample Blackboard Plan (Lesson 76)

Date: \_\_\_\_\_ Chapter: 8 Fractions Sub- chapter: 3. Fractions, Decimals and Whole Numbers Lesson Number: 2/5

**MT:** To understand that division of whole numbers can be expressed as a fraction.

**2** Let's find the length of one section when 1m, 2m and 3m string is divided into 4 equal parts?

**1** Expression:  $3 \div 4$

1 m .....  $1 \div 4 = \frac{1}{4}$       answer :  $\frac{1}{4}$  m

2 m.....  $2 \div 4 = \frac{2}{4}$  m

3 m .....  $3 \div 4 = \frac{3}{4}$  m

What is the length for one section?

**MT:** Introduce the main task here

$1 \div 4 = \frac{1}{4}$

$2 \div 4 = \frac{2}{4}$

$3 \div 4 = \frac{3}{4}$

The quotient of a division problem in which a whole number is divided by another whole number can be expressed as a fraction.

**Exercise**  
Complete 1 - 4

**Summary**  
Division problem of whole number divided by a whole number can be expressed as a fraction.

P 153

**Lesson Objective**

- Change or convert fractions to decimal numbers or whole numbers.

**Prior Knowledge**

- Quotient of division of whole numbers is always expressed as a fraction.
- How to express quotients as whole numbers, exactly as decimal numbers and not expressed exactly as decimal numbers.

**Preparation**

- Number lines for activity **3** **2**

**Assessment**

- Think about how to convert fractions to decimal numbers or whole numbers. **F**
- Change or convert fractions to decimal numbers or whole numbers. **S**

**Teacher's Notes**

- 3** Quotient in fraction or decimal.

Quotient is in fraction.

$$2 \div 5 = \frac{2}{5}$$

Quotient is in decimal.

$$2 \div 5 = 0.4$$

- 4** Comparison of fraction and decimal.

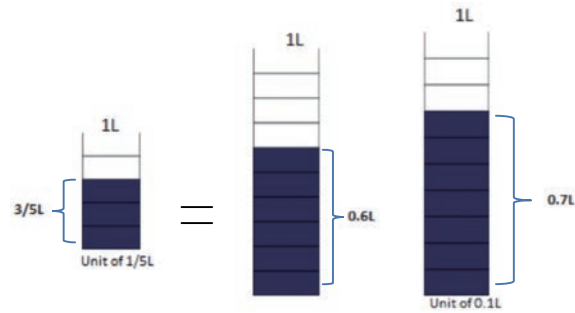

$\frac{3}{5}$  L is equal to 0.6 L. Comparing 0.6 L and 0.7 L  
 $0.6 \text{ L} < 0.7 \text{ L}$  therefore  $\frac{3}{5} \text{ L} < 0.7$

**Fractions, Decimals and Whole Numbers**

- 3** If we divide a 2 m tape into 5 equal sections, how many metres long will be each section?

- 1** Let's express the answer as a fraction and as a decimal number.

$$2 \div 5 = \frac{2}{5} \quad 2 \div 5 = 0.4$$

- 2** Let's write this fraction and decimal number on the number line.

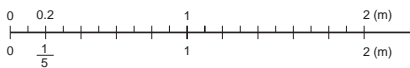

- 4** Which is larger  $\frac{3}{5}$  L or 0.7 L?

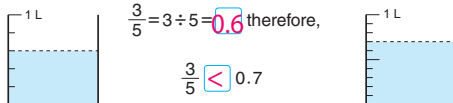

To represent a fraction as a decimal number or whole number, we divide the numerator by the denominator.

- 5** Let's express these fractions as decimal numbers or whole numbers.

**1**  $\frac{3}{10} = 0.3$

**2**  $\frac{29}{100} = 0.29$

**3**  $\frac{12}{4} = 12 \div 4 = 3$

**4**  $1 \frac{3}{5} = \frac{8}{5} = 8 \div 5 = 1.6$

## Lesson Flow

**1** Review the previous lesson.

**2** **3** Think about dividing 2 m into 5 equal sections.

**T** Introduce the Main Task. (Refer to the BP)

**T** Ask the students to think about how to divide 2 m into 5 equal sections.

**S** Think about how to divide 2 m into 5 equal sections and complete **1** and **2**.

**T** Confirm students' answers.

**3** **4** Compare  $\frac{3}{5}$  L and 0.7 L

**T** Ask the students to compare the fraction  $\frac{3}{5}$  L and the decimal 0.7 L by observing the diagram representation and filling in the box .

**S** Observe the diagram and fill in the box .

**T** To confirm the answer observe the diagram representation in the unit of  $\frac{1}{5}$  L and the unit of 0.1 L and explain to the students. (Refer to teacher's notes)

**4** **5** Express fractions as decimal numbers or whole numbers.

**S** Complete **1**, **2**, **3** and **4** by expressing the fractions as decimal numbers or whole numbers.

**T** Check and assist those in need. Give ample time and ask volunteers to share their ideas and answers.

**5** Summary

**T** What have you learned in this lesson?

**S** Present ideas on what they have learned.

**T** Use students' ideas to confirm the important concepts of this lesson.

## Sample Blackboard Plan

Date:
Chapter:8 Fractions
Sub- chapter:3. Fractions, Decimals and Whole Numbers
Lesson Number: 3/5

**MT:** To compare which is larger,  $\frac{3}{5}$  or 0.7.

**Fractions, Decimals and Whole Numbers**

**3** If we divide a 2m tape into 5 equal sections, how many metres long is each section?

Answer as a fraction.  $2 \div 5 = \frac{2}{5}$   
answer  $\frac{2}{5}$  m

Answer as in decimal.  $2 \div 5 = 0.4$   
answer 0.4 m



$\frac{2}{5} = 2 \div 5 = 0.4$

**4** Which is larger  $\frac{3}{5}$  L or 0.7L?

**1** To represent a fraction as a decimal number or whole number, divide the numerator by the denominator.

$\frac{3}{5} = 3 \div 5 = 0.6$



**2**  $0.1 = \frac{1}{10}$ ,  $0.7 = \frac{7}{10}$ ,  $\frac{3}{5} = \frac{6}{10}$

0.6 is smaller than 0.7  
Therefore  $\frac{3}{5} < 0.7$

To represent a fraction as a decimal number or whole number we divide the numerator by the denominator.

**5** Let's express these factors as decimal numbers or whole numbers.

**Complete 1 to 4.**

**Summary**  
When expressing a fraction as a decimal number or whole number, we divide the numerator by the denominator.

**MT:** Introduce the main task here.

# Unit 8

## Unit: Fraction Sub-unit 3: Fractions, Decimals and Whole Numbers Lesson 4 of 5

Textbook Page :  
119  
Actual Lesson 078

### Lesson Objective

- To express whole numbers and decimal numbers as fractions or vice versa.

### Prior Knowledge

- How to express quotient in fraction or decimal.
- How to express fractions as decimal numbers or whole numbers.

### Preparation

- Chart of enlarged number line

### Assessment

- Think about how to express whole numbers and decimal numbers as fractions or vice versa. **F**
- Convert whole numbers and decimal numbers to fractions or vice versa correctly. **F**
- Solve the exercise correctly. **S**

### Teacher's Notes

$\frac{1}{10}$  as the unit  $\rightarrow$  is sets of 0.1

$\frac{1}{100}$  as the unit  $\rightarrow$  is sets of 0.01

1.7 is 17 sets of 0.1 or  
17 sets of  $\frac{1}{10}$  or  $\frac{17}{10}$

0.19 is 19 sets of 0.01 or  
19 sets of  $\frac{1}{100}$  or  $\frac{19}{100}$

6 Let's express 2 and 5 as fractions.

$$2 = 2 \div 1 = \frac{2}{1}$$

$$5 = 5 \div 1 = \frac{5}{1}$$

$$2 = 4 \div 2 = \frac{4}{2}$$

$$5 = 10 \div 2 = \frac{10}{2}$$

$$2 = 8 \div 4 = \frac{8}{4}$$

$$5 = 30 \div 6 = \frac{30}{6}$$



Whole numbers can be expressed as fractions no matter what number you choose for the denominator.

7 Let's express the decimal numbers 0.19 and 1.7 as fractions.

1 Since 0.19 is 19 sets of 0.01,

we can think of this as 19 sets of  $\frac{1}{100}$  and get  $\frac{19}{100}$

2 Since 1.7 is 17 sets of 0.1,

we can think of this as 17 sets of  $\frac{1}{10}$  and get  $\frac{17}{10}$



Decimal numbers can be expressed as fractions if we choose  $\frac{1}{10}$  and  $\frac{1}{100}$  as the units.

#### Exercise

Fill in the  with decimals and fractions.

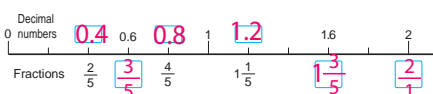

-  = 119

## Lesson Flow

**1** Review the previous lesson.

**2** **6** Think about how to express 2 and 5 as fractions.

**T** Introduce the Main Task. (Refer to the BP)

**S** Think about how to express 2 and 5 as fractions by filling in the box  and share their answers.

**3** Important Point

**T/S** Explain the important point in the box .

**4** **7** Expressing the decimal numbers 0.19 and 1.7 as fractions.

**S** Express 0.19 and 1.7 as fractions using sets of 0.01 and 0.1 by filling in the box .

**5** Important Point

**T/S** Explain the important point in the box .

**6** Complete the Exercise

**S** Solve the selected exercises.

**T** Confirm students' answers.

**7** Summary

**T** What have you learned in this lesson?

**S** Present ideas on what they have learned.

**T** Use students' ideas to confirm the important concepts of this lesson.

## Sample Blackboard Plan

Date:	Chapter: 8 Fraction	Sub- chapter: Fractions, Decimals and Whole Numbers	Lesson Number: 4/5
-------	---------------------	---	--------------------

MT: Let's express decimal numbers as fractions .

**MT:** Introduce the main task here.

**6** Let's express 2 and 5 as fractions.

$2 = 2 \div 1 = \frac{2}{1}$	$5 = 5 \div 1 = \frac{5}{1}$
$2 = 4 \div 2 = \frac{4}{2}$	$5 = 10 \div 2 = \frac{10}{2}$
$2 = 8 \div 4 = \frac{8}{4}$	$5 = 30 \div 6 = \frac{30}{6}$

Whole numbers can be expressed as fractions no matter what number you choose for the denominator.

**7** Let's express the decimal numbers 0.19 and 1.7 as fractions.

**1** 0.19 is 19 sets of 0.01  
19 sets of  $\frac{1}{100}$  is  $\frac{19}{100}$

**2** 1.7 is 17 sets of 0.1  
17 sets of  $\frac{1}{10}$  is  $\frac{17}{10} = 1 \frac{7}{10}$

Decimal numbers can be expressed as fractions if we choose  $\frac{1}{10}$  and  $\frac{1}{100}$  as the units.

**Exercise**  
Fill in the  with decimals and fractions.

Decimal numbers	→ 0.4	0.8	1.2	1.6	?
Fractions	→ $\frac{2}{5}$	$\frac{3}{5}$	$\frac{4}{5}$	$1 \frac{3}{5}$	$\frac{2}{1}$

**Summary**  
Whole numbers and decimal numbers can be expressed as fractions or vice versa.

**Lesson Objectives**

- To categorise fractions in three groups as whole numbers, actual decimal numbers and other decimal numbers.
- Recognise, identify and represent fractions using the number line.

**Prior Knowledge**

- Express fraction as decimal number or whole number.
- Express whole number and decimal number as fraction.

**Preparation**

- Number line for **9**

**Assessment**

- Categorise fraction in three groups as whole number, actual decimal number and other decimal number. **F S**
- Identify and represent fraction using the number line. **F S**
- Solve the exercise correctly. **S**

**Teacher's Notes**

Emphasise to students that any number such as whole numbers, fractions and decimal numbers can all be represented in a same number line.

**8** Let's divide the following fractions into 3 groups.

$$\frac{8}{10}, 1\frac{1}{2}, \frac{4}{11}, \frac{3}{5}, \frac{3}{1}, 2\frac{1}{3}, \frac{6}{3}$$

(A) Whole numbers.

$$\frac{3}{1} \text{ and } \frac{6}{3}$$

(B) Accurate decimal numbers.

$$\frac{8}{10}, 1\frac{1}{2}, \frac{3}{5}$$

(C) Other decimal numbers.

$$\frac{4}{11}, 2\frac{1}{3}$$

**9** Let's place these numbers on the number line below.

$$\frac{4}{11}, \frac{4}{5}, 0.6, 1\frac{7}{20}, 2, 1.25, \frac{1}{4}, \frac{2}{3}$$



Whole numbers, decimal numbers and fractions can all be expressed on one number line. That makes it easy to compare numbers.

Changing fractions to decimal numbers makes them easier to compare.

$$\frac{2}{3} = 2 \div 3 = 0.666\dots \text{about } 0.67$$

**Exercise**

**1** Let's line up these numbers starting from the smallest.

$$1.3, (4), .75, (3), \frac{4}{2}, (6), 1\frac{1}{2}, (5), \frac{7}{10}, \frac{5}{7}$$

**2** Let's change decimals to fractions and fractions to decimals or whole numbers.

$$\textcircled{1} 0.9 \quad \textcircled{2} 1.25 \quad \textcircled{3} \frac{3}{4} \quad \textcircled{4} \frac{24}{6} \quad \textcircled{5} 1\frac{2}{5}$$

$$\frac{9}{10} \quad 1\frac{1}{4} \quad 0.75 \quad 4 \quad 1.4$$

## Lesson Flow

**1** Review the previous lesson.

**2** **8** Divide the fractions into three (3) groups.

**T** Introduce the Main Task. (Refer to the Blackboard Plan)

**S** Observe the different fractions and categorise the given fractions into 3 groups as whole numbers, actual decimal numbers or other decimal numbers by filling in the box  for **(A)**, **(B)** and **(C)**.

**3** **9** Representation of fractions, decimal numbers and whole numbers on the number line.

**S** Use the number line to place the fractions, decimal numbers and whole numbers correctly with an  $\surd$  and present their answers.

**T** Confirm students' answers.

**4** Important Point

**T/S** Explain the important point in the box .

**5** Complete the Exercise

**S** Solve the selected exercises.

**T** Confirm students' answers.

**6** Summary

**T** What have you learned in this lesson?

**S** Present ideas on what they have learned.

**T** Use students' ideas to confirm the important concepts of this lesson.

## Sample Blackboard Plan

Date: \_\_\_\_\_ Chapter: 8. Fractions Sub- chapter: 3. Fractions, Decimals and Whole Numbers Lesson Number: 5/5

**MT:** Let's categorize the types of fractions all on a number line.

**MT:** Introduce the main task here.

**8** Let's divide the following fractions into 3 groups.  
 $8/10$ ,  $11/2$ ,  $4/11$ ,  $3/5$ ,  $3/1$ ,  $21/3$ ,  $6/3$

$8/10 = 8 \div 10 = 0.8$  accurate decimal number.

$11/2 = 3 \frac{5}{2} = 3 + 2 = 1.5$  accurate decimal number.

$4/11 = 4 \div 11 = 0.363636\dots$  other decimal number.

$3/5 = 3 \div 5 = 0.6$  accurate decimal number.

$3/1 = 3 \div 1 = 3$  whole number.

$21/3 = 7 \div 3 = 2.3333\dots$  other decimal number.

$6/3 = 6 \div 3 = 2$  whole number.

$\frac{21}{27} = \square \div \square$   
 To represent fraction as a decimal or whole number divide the numerator by the denominator.

**9** Let's express whole numbers, decimal numbers and fractions on the number line.  
 $4/11$ ,  $4/5$ ,  $0.6$ ,  $17/20$ ,  $2$ ,  $1.25$ ,  $1/4$ ,  $2/3$

- Decimal unit is 0.1
- Fraction unit is  $1/10$

Whole numbers, decimal numbers and fractions can all be expressed on one number line.  
That makes it easy to compare numbers.

**Exercise**  
Complete **1** and **2**.

**Summary**  
Whole numbers, decimal numbers and fractions can all be expressed on one number line.  
That makes it easy to compare numbers.

### Lesson Objectives

- To confirm their understanding on the concepts they learned in this unit by completing the Exercise and the Evaluation Test confidently.

### Prior Knowledge

- All the contents covered in this unit

### Preparation

- Copies of evaluation test for each student

### Assessment

- Complete the Exercise correctly. **S**

### Teacher's Notes

This is the last lesson of Chapter 8. Students should be encouraged to use the necessary skills learned in this unit to complete all the Exercises and solve the Problems in preparation for the evaluation test. The test can be conducted as assesment for your class after completing all the exercises. Use the attached evaluation test to conduct assesment for your class after finishing all the exercises and problems as a separate lesson.

## EXERCISE

- ① Let's change fractions using common denominators by filling in the  $\square$  with inequality signs. Pages 110 to 111, 115

①  $\frac{2}{3} > \frac{1}{2}$     ②  $\frac{3}{4} > \frac{5}{7}$     ③  $\frac{1}{6} < \frac{5}{18}$     ④  $\frac{6}{3} > \frac{5}{12}$   
 $\frac{4}{6} > \frac{3}{6}$      $\frac{21}{28} > \frac{20}{28}$      $\frac{3}{3} < \frac{5}{3}$      $\frac{16}{36} > \frac{15}{36}$

- ② Let's reduce these fractions. Pages 114 to 115

①  $\frac{4}{8} = \frac{1}{2}$     ②  $\frac{6}{9} = \frac{2}{3}$     ③  $\frac{21}{28} = \frac{3}{4}$     ④  $\frac{16}{24} = \frac{2}{3}$     ⑤  $\frac{75}{100} = \frac{3}{4}$

- ③ Let's represent their quotients by fractions. Pages 116 to 117

①  $1 \div 7 = \frac{1}{7}$     ②  $5 \div 9 = \frac{5}{9}$     ③  $11 \div 3 = \frac{11}{3}$

- ④ Let's represent these fractions by decimals or whole numbers. Pages 118 to 120

①  $\frac{5}{10} = 0.5$     ②  $\frac{31}{100} = 0.31$     ③  $\frac{18}{6} = 3$     ④  $1 - \frac{1}{4} = 1.25$

- ⑤ Let's represent these decimals with fractions. Pages 119 to 120

①  $0.3 = \frac{3}{10}$     ②  $1.9 = \frac{19}{10}$     ③  $0.61 = \frac{61}{100}$     ④  $1.11 = \frac{111}{100}$

- ⑥ Let's write  $\downarrow$  for numbers on the number line. Pages 118 to 120

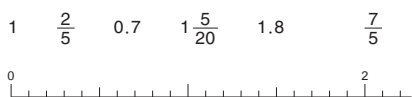

Let's calculate.

①  $\frac{1}{5} + \frac{1}{5} = \frac{2}{5}$     ②  $\frac{2}{7} + \frac{5}{7} = 1$     ③  $1\frac{2}{4} + \frac{3}{4} = \frac{9}{4} (2\frac{1}{4})$   
 ④  $1\frac{5}{7} - \frac{6}{7} = \frac{6}{7}$     ⑤  $2\frac{3}{5} - 1\frac{4}{5} = \frac{4}{5}$     ⑥  $2 - \frac{5}{8} = \frac{11}{8} (1\frac{3}{8})$



## Lesson Flow

### 1 Complete the Exercise

- S Solve all the exercises.
- T Confirm students' answers.
- TN
  - ① Changing fractions using common denominators.
  - ② Reducing fractions.
  - ③ Representing quotients by fractions.
  - ④ Representing fractions by decimals or whole numbers.
  - ⑤ Represent decimals by fractions.
  - ⑥ Identifying fractions and decimals on the number line.

### 2 Complete the Evaluation Test

- TN Use the attached evaluation test to conduct assesment for your class after finishing all the exercises and problems as a seperate lesson.
- S Complete the Evaluation Test.

End of Chapter Test:	Date:	
Chapter 8: Fraction	Name:	Score / 100

1. Fill numbers in . [4 x 5 marks = 20 marks]

(1)  $\frac{3}{5} = \frac{6}{10} = \frac{12}{24}$       (2)  $\frac{18}{24} = \frac{9}{12} = \frac{6}{8}$

2. Reduce a fraction of  $\frac{27}{36}$  [10 marks]  
 Answer:

3. Change fraction of  $\frac{1}{4}$  and  $\frac{5}{6}$  into faractions with least common denominators. [2 x 10 marks]  
 Answer:  and

4. Write < or > in  by comparing the fractions. [10 marks]  
 $\frac{1}{4}$    $\frac{7}{12}$       Answer:

5. Express  $16 \div 12$  as a fraction. [10 marks]  
 Answer:

6. Express  $2\frac{3}{4}$  as a decimal number. [10 marks] Answer:

7. Express 0.55 as a fraction. [10 marks] Answer:

8. Write ↑ for the following numbers on the number line below as it is shown. [2 x 10 marks]  
 Example (1) 2      (2)  $\frac{3}{5}$       (3)  $1\frac{1}{2}$

**End of Chapter Test**

**Date:**

Chapter 8: Fraction	Name:	Score / 100
------------------------	-------	----------------

1. Fill in the numbers in the  $\square$ .

[4 × 5 marks = 20 marks]

(1)  $\frac{3}{5} = \frac{\square}{10} = \frac{12}{\square}$

(2)  $\frac{18}{24} = \frac{\square}{12} = \frac{6}{\square}$

2. Reduce the fraction of  $\frac{27}{36}$

[10 marks]

Answer:

3. Change the fractions  $\frac{1}{4}$  and  $\frac{5}{6}$  into fractions with least common denominators.

[2 × 10 marks]

Answer:  and

4. Write < or > in the  $\square$  by comparing the fractions.

[10 marks]

$\frac{1}{4} \square \frac{7}{12}$

Answer:   $\frac{1}{4} \square \frac{7}{12}$

5. Express  $16 \div 12$  as a fraction.

[10 marks]

Answer:

6. Express  $2\frac{3}{4}$  as a decimal number.

[10 marks]

Answer:

7. Express 0.55 as a fraction.

[10 marks]

Answer:

8. Draw an  $\uparrow$  for the following numbers on the number line below as it is shown.

[2 × 10 marks]

Example (1) 2

(2)  $\frac{3}{5}$

(3)  $1\frac{1}{2}$

