



Government of Malawi

Rural Water Supply Operation and Maintenance Series 1

Community Based Management (O & M Refresher Course) Training Manual



Ministry of Agriculture, Irrigation and Water Development

March 2015



Rural Water Supply Operation and Maintenance Series 1

**Community Based Management
(O & M Refresher Course)
Training Manual**

Ministry of Agriculture, Irrigation and Water Development

March 2015

Ministry of Agriculture, Irrigation and Water Development
Tikwere House,
City Centre,
P/Bag 390,
Lilongwe 3,
Malawi
Telephone No.: (265) 1 770 211 / 770 233 / 770 344 / 770 447
Fax No.: (265) 01 773 737
E-mail: secretary@irriwater.org

Date of publication: March 2015

137p

Rural Water Supply Operation and Maintenance Series 1

This document was published by Ministry of Agriculture, Irrigation and Water Development (MoAIWD) of Malawi with the technical and financial support of the Japan International Cooperation Agency (JICA) through the “Project for Enhancement of Operation and Maintenance for Rural Water Supply in the Republic of Malawi”.

The copyright of this document shall exclusively remain with MoAIWD and JICA (MoAIWD and JICA are hereinafter referred to as the “copyright holders”). The copyright holders allow anyone to use this document as long as it is used for the purpose of public good. Any parts of this document including the illustrations may be copied to meet local needs without permission from the copyright holders, provided that the copies are

- (a) distributed for free and used for the good of people;
- (b) not used for profit making;
- (c) referred with the source of information.

For making any modifications, reprinting and/or using any part of the document for commercial purposes, please ask permission of the copyright holders at the following contacts;

Director of Water Supply Services
Ministry of Agriculture, Irrigation and Water Development

Country Representative of JICA Malawi Office
Telephone No: (265) 01 771 554 / 644 / 945

TABLE OF CONTENTS

PREFACE	v
ACKNOWLEDGEMENT	vi
ACRONYMS	vii
INTRODUCTION.....	1
Overview	1
How to use the Modules	2
How to select the target WPCs receiving the CBM O&M refresher training ...	3
Module 1: Identifying the O&M issues.....	6
Session 1: O&M Issues in Our Communities	7
Session 2: Developing the CBM O&M Refresher Training Timetable.....	11
Module 2: Financial Management	13
Session 1: General Principles of Financial Management	14
Session 2: Tariff Setting	17
Session 3: Accounting and Book keeping.....	24
Session 4: Promotion Materials for the Promotion of Regular Payment of Water Fees.....	29
Module 3: Water Point Sanitation and Hygiene.....	33
Session 1: Identifying the Sources of Contamination of Water Points	34
Session 2: Decision-Making for the Selection and Construction of Appropriate Water Point Sanitation Facilities	40
Session 3: Promotion Materials for Water Point Sanitation	47
Session 4: Sanitation and Hygiene.....	51
Module 4: Technical Components.....	54
Session 1: Components of the Water Supply Facility	55
Session 2: Afridev Handpump Parts, Functions and Life Period.....	57

Session 3: Pumping Mechanism	63
Session 4: O&M Schedule	65
Session 5: Trouble Shooting	76
Session 6: Security System for Afridev Handpumps	87
Module 5: Roles of Different Players	89
Session 1: Roles and Responsibilities of the Community	90
Session 2: Roles and Responsibilities of Other Stakeholders	92
Module 6: Planning for Operation and Maintenance	97
Session 1: Community Action Cycle for O&M	98
Session 2: Facility Management Plan (FMP)	100
Module 7: Mainstreaming Crosscutting Issues.....	104
Session 1: Gender	105
Session 2: HIV and AIDS.....	108
Session 3: Environment.....	111
Module 8: Community Mobilization.....	115
Session 1: Organizing the first meeting with the beneficiaries	116
Session 2: Providing regular support to WPCs/VHWCs through Monitoring and Evaluation.....	119
Module 9: Monitoring & Evaluation	121
Session 1: What is Monitoring and Evaluation?	122
Session 2: How to carry out monitoring and evaluation	124
APPENDICES.....	127
1. LIST OF PARTICIPANTS IN THE MANUAL PRODUCTION.	128
2. PREPARATION OF THE TRAINING FOR WPCs	129

PREFACE

Millions of Malawians, mostly rural, still lack access to clean water and are thus exposed to a number of water and sanitation diseases, such as diarrhoea, cholera, etc. Addressing this issue is a key component of the Malawi Growth and Development Strategy (MGDS). To ensure access to clean safe water in the country, Malawi must build not only the required infrastructure, but also the appropriate institutional systems which can effectively oversee, guide and manage the construction and ongoing operation and maintenance (O&M).

In the past, the Malawi government took full responsibility of the O&M of rural water supply facilities. However, this system was marred by numerous inefficiencies making it unsustainable. Without a strong presence in communities, these water supply facilities would often fall into disrepair, but also experience other issues such as catchment encroachment and vandalism.

In response, the National Decentralization Policy, instated in 1998 by the Malawi Government, emphasizes community empowerment through a transfer of power and responsibility to local authorities. Since then, there has been an increasing emphasis on developing community ownership through the adoption of practices like Community Based Management (CBM) trainings.

The notable challenges lie in accessibility and functionality of the existing water points as well as using them sustainably due to ever increasing demand from the growing population. However, most boreholes break down due to ineffective village level operation and maintenance. Cases of theft and vandalism of boreholes have also been reported due to lack of community ownership and responsibility.

This Community Based Management Refresher Manual is designed to provide a harmonised approach for carrying out water and sanitation services by various stakeholders to ensure sustainable implementation of water supply services at community level.

It is hoped that all stakeholders use this manual when implementing community water and sanitation programmes to ensure uniformity of approaches as well as sustainability of old and new water supply facilities and that Malawi can move ahead in providing access to safe water for all Malawians. Any substantive comments for improvement on the manual are welcome and should be directed to the secretary responsible for water development.



Sandram C. V. Maweru

SECRETARY FOR IRRIGATION AND WATER DEVELOPMENT

ACKNOWLEDGEMENT

This manual was produced by the “Project for Enhancement of Operation and Maintenance for Rural Water Supply in the Republic of Malawi” under the technical cooperation by Japan International Cooperation Agency (JICA).

A series of workshops were held in the project, and a lot of stakeholders in Malawi, development partners, and NGOs technically contributed in the formulation of the manual. The Ministry of Agriculture, Irrigation and Water Development therefore, extends special thanks to these stakeholders for allowing their staff to participate in the production of this manual.

The Ministry is also indebted to JICA for assisting in the development of the manual, and many who have not been mentioned here but contributed in different ways.

ACRONYMS

AIDS	Acquired Immune Deficiency Syndrome
ADC	Area Development Committee
AM	Area Mechanic
CBM	Community Based Management
CDA	Community Development Assistant
DCDO	District Community Development Officer
DCT	District Coordinating Team
DEHO	District Environmental Health Office
DDEHO	Deputy District Environmental Health Officer
DPD	Director of Planning and Development
DC	District Commissioner
DWDO	District Water Development Officer
ESAs	External Support Agencies
EWs	Extension Workers
EWT	Extension Workers Team
FMP	Facility Management Plan
HIV	Human Immunodeficiency Virus
HSA	Health Surveillance Assistant
HTC	HIV and AIDS Testing and Counselling
JICA	Japan International Cooperation Agency
LCC	Life Cycle Cost
M&E	Monitoring and Evaluation
MGDS	Malawi Growth and Development Strategy
MoAIWD	Ministry of Agriculture, Irrigation and Water Development
NSO	National Statistic Office
NGO	Non-Governmental Organisation
O&M	Operation and Maintenance
PCI	Price Consumer Index
SHSA	Senior Health Surveillance Assistant
SPRS	Spare Parts Retail Shops
SPRSOs	Spare Parts Retail Shop Owners
TA	Traditional Authority
VDC	Village Development Committee.
VHWC	Village Health and Water Committee
VLOM	Village Level Operation and Maintenance
WASH	Water Sanitation and Hygiene
WMA	Water Monitoring Assistant
WPC	Water Point Committee

WUA

Water Users Association

WSS

Water Supply and Sanitation

INTRODUCTION

Overview

Currently, the community based management (CBM) training is provided to the beneficiaries only when the water supply facilities are first constructed (before and after construction). However, several years could pass after construction before the water supply facilities begin to deteriorate and break down, requiring maintenance. Therefore, it is likely that, for a few years after construction, the beneficiaries never make use of what has been learned in the CBM training, and do not carry out appropriate maintenance on many of the facilities. When the water supply facilities begin to deteriorate, the Water Point Committee (WPC) members who received training may have forgotten what they learned, or the WPC may have different members, and Area Mechanics (AMs) or spare parts supply retail shops may also differ from the time when the CBM training was provided.

Additionally, since the CBM training was introduced in the 1990's to cover only newly-constructed water supply facilities, communities with water supply facilities that were constructed before the introduction of the CBM training are not trained. Therefore, communities operating water supply facilities that were constructed before the introduction of CBM have not received any CBM training and do not know the existing framework, such as responsibilities of communities towards their water supply facilities and the responsibilities of the district and the national governments.

To overcome these challenges, the institutionalization of the CBM Operation and Maintenance (O&M) refresher training was proposed. If the beneficiaries receive refresher training once every few years in addition to training at the time of construction, communities with water supply facilities in need of repair will be able to deal with the situation appropriately and will have the opportunity to express their needs to the district and national governments, which in turn can make use of this opportunity to determine the current status of water supply facilities. Consequently, this might help in reducing the non-functionality rate of water supply facilities in the country.

How to use the Modules

The different modules in this training manual were selected based on problems faced by WPC members regarding the operation and maintenance of their boreholes through a baseline survey conducted in 2011 that covered about 1,000 boreholes in Mchinji district.

It is not necessary to cover all the modules and sessions of this training manual, instead, it is important that the Extension Workers (EWs) first identify the problems that the WPCs are facing in order to select those modules and sessions they need to be “refreshed” on or “deepen their existing knowledge”.

“Modules” are detailed descriptions of how to run each session in a workshop. Each module consists of the following components:

Introduction:	Overall information on the content of the module
Objectives:	What trainees will learn in each module
Content:	The different sessions covered in the module

“Sessions” are detailed descriptions on how to conduct each “Activity”. Sessions include information on:

Introduction:	Overall information on the content of the session
Learning Objectives:	What trainees will learn in each session
Tool Kit:	The tools used in each activity. Tool Kit is compiled as a supporting book.
Contents:	Includes step by step activities and detailed explanation on how to conduct the activities and information required by the trainer to conduct the activities

How to select the target WPCs receiving the CBM O&M refresher training

Selection process

The selection process of target water points is divided into three steps as follows unless the water points were already being identified or requested by the communities:

- Step 1 Conduct field survey of target water point using a questionnaire (Refer to Tool 1)
- Step 2: Conduct the primary selection based on the selection criteria
- Step 3 Quantify the O&M management condition in each of the selected water points in Step 1

Description of each selection step is as follows:

Step 1: Selecting the target WPCs

The selection process and criteria may vary from district to district. Some districts have a database with information on WPCs that are active and functional so it might be easy to prioritize and select those in need of refresher training. Others might already have a list of communities that have requested refresher training. However, a vast number of districts may not know how to start the selection process due to lack of updated data on the status of water points. In this case, it is recommended that a field survey is conducted using a questionnaire shown in **Tool 1 “Pre-survey Form”** that includes criteria shown in Fig. 1.

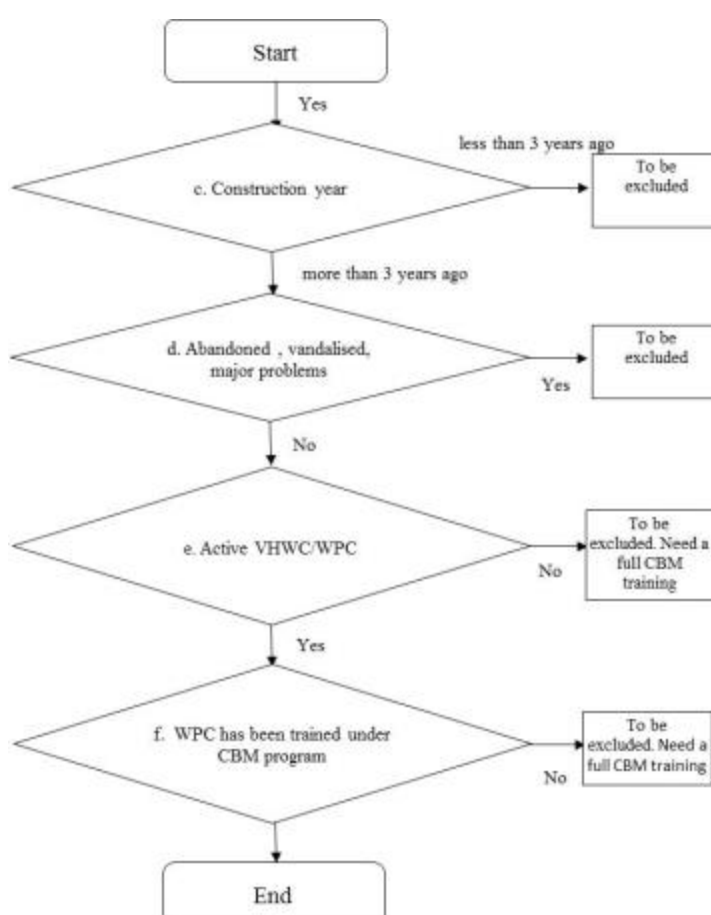

Figure 1: Selection criteria for primary selection

Step 2: Second selection

In some cases, funding might not be sufficient for conducting refresher training in all WPCs that require. In this case, there is need to further prioritize through a second selection that could be conducted in water points selected in Step 1 based on the following:

- 1) The current O&M management conditions of the water points to be quantified using field survey data.
- 2) The water points with high score (meaning O&M by the community is not properly conducted due to poor management) to be prioritized for the selection of target facilities for receiving the CBM refresher training.
- 3) The number of target water points might be equally selected from each health center to maintain a balanced distribution of target sites.

O&M management indicators and scores for selecting candidate WPCs for refresher training are shown in the table below.

Table 1: O&M management indicators and scores for selecting target WPCs for refresher training

O&M management indicators	Judgment and Score			
	Judgment	Score	Judgment	Score
Availability of soak away pit	Available	0	Not available	1
Availability of fence	Available	0	Not available	1
Surrounding environment	Clean	0	Not clean	1
Regular payment for water	Yes	0	No	1
Regular maintenance	Conducted	0	Not conducted	1
Awareness of AMs in catchment area	Aware	0	Not aware	1
Awareness of spare parts shop	Aware	0	Not aware	1
	Minimum score	0	Maximum score	8

Module 1: Identifying the O&M issues

Introduction

The first step after the target WPCs have been identified is to find out what are the main O&M issues that each WPC is facing.

This will allow the Extension Workers (EWs) to select the modules or specific sessions in the module from this refresher training manual in order to develop a training syllabus that is tailor made to the needs of that particular WPC.

Objectives

By the end of the module, participants should be able to:

1. Identify the WPC's main O&M issues
2. Develop a CBM O&M refresher training timetable that is focused on the main O&M issues identified.

Content

The module covers the following sessions:

Session 1: O&M issues in our communities

Session 2: Developing the CBM O&M refresher training timetable

Session 1: O&M Issues in Our Communities

Introduction

This session provides an opportunity to identify some of the O&M issues in depth and come up with solutions by identifying first the issues.

Learning Objectives

By the end of this session, participants will be able to identify important O&M issues

Tool Kit

Tool 2: Unserialized Posters on O&M Issues

Content

Identifying important O&M issues

Activity 1.1

Step 1

Facilitator asks participants to form groups of 3 to 8 persons. Each group is to be provided with a set of unserialized posters.

Step 2

Facilitator gives the group a task by saying:

“Each group will choose one drawing from the set that is the most critical issue in their community. Discuss within your group and develop a story of your community using the drawings.” If the drawings are not reflecting the main issues in their villages, villagers can develop their own stories and/or drawings.

Step 3



Facilitator summarises the main issues in the communities.



The drawings in the unserialized posters are representing common issues found in the WPCs when operating and maintaining their boreholes.

Sample unserialized posters for O&M issues are shown as below.

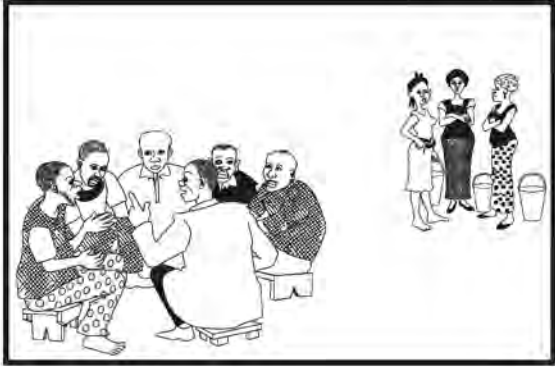
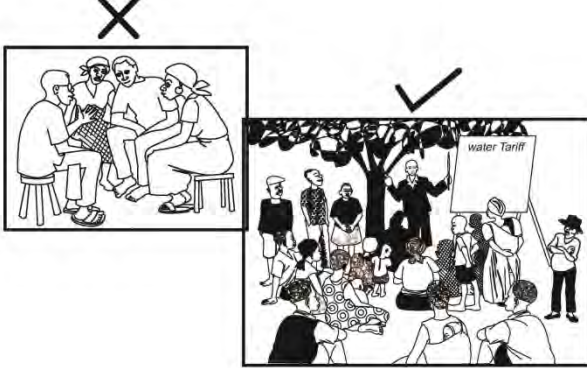
Table 2: Sample unserialized posters for O&M issues

O&M issues	Sample unserialized posters
Members are selected on the basis of favouritism, e.g., chief's friends or relatives	-

O&M issues	Sample unserialized posters
<p>Women and minority groups are left out of committees and decision making</p>	
<p>Domination by a few people (e.g., chairman, secretary) who make all the decisions</p>	
<p>Low levels of initiative & responsibility – they tend to wait for outsiders to tell them what to do</p>	<p style="text-align: center;">-</p>
<p>Few meetings – they meet only when the water point breaks down or when there is a project</p>	<p style="text-align: center;">-</p>
<p>Money is poorly handled and recorded – there are some cases of misappropriation</p>	
<p>Lack of accountability so the community has no trust in the committee</p>	

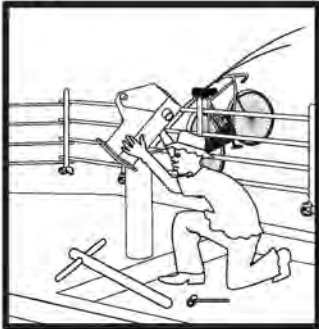
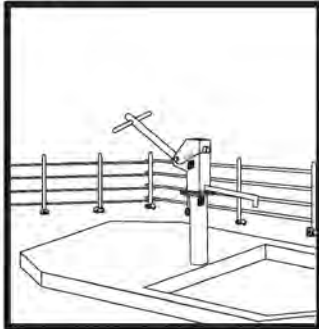
O&M issues	Sample unserialized posters
	
Roles of members not followed	-
Drop outs not being replaced	-
Facilities working without WPCs	-
People refuse or unable to contribute	
Vandalism (lack of security for the handpump)	<div style="display: flex; justify-content: space-around; align-items: center;"> <div style="text-align: center;"> <p>✗</p>  </div> <div style="text-align: center;"> <p>✓</p>  </div> </div>

O&M issues	Sample unserialized posters
<p>Villagers use alternative water source such as shallow well, rather than borehole with handpump</p>	

Session 2: Developing the CBM O&M Refresher Training Timetable

Introduction

This session will equip facilitators on how to develop training timetable for CBM O&M refresher course based on the O&M issues identified in Session 1.

Learning Objectives

By the end of this session, facilitators will be able to develop the training contents

Tool Kit

Tool 3: Sample Training Timetable for CBM O&M Refresher Course

Content

Selecting the training modules

Activity 1.2

Step 1

Facilitator asks participants to list the topics that will be covered in order to meet of the specific training contents based on the O&M issues identified in Session 1.

Step 2

Facilitator asks participants to prioritize the training contents to be covered and develop a timetable for the training course outlining how each session is to be conducted and the time required.

Points for determining the content and timetable of the training

- Brainstorm with EW team all the important subjects and leaning points
- Arrange the subjects into a logical order
- Break the session into a series of clear, simple steps that can be assimilated easily by the participants
- Ensure each subject is linked to the next to ensure a step-by-step process

Points for determining the methods and timetable of the training

Participatory methods are recommended as the community training. These methods encourage the participation of individuals in a group process, no matter what their age, sex, social class or educational background and are designed to build self-esteem and a sense of responsibility for one's decisions. They try to make the process of decision-making easy and fun. They are designed for planning at community level. Participants learn from each other and develop respect for each other's knowledge and skills.

The following are key points for the participatory methods.

- **DISCUSSION** is the core method. It gets trainees to learn actively through talking and sharing ideas with others, rather than listening to the trainer.

- **PRESENTATIONS** should be kept to a minimum. Only use them to give summaries at the end of discussion sessions. Try to keep them short and interesting.
- **SMALL GROUPS** get everyone involved. Some trainees feel shy in a large group but in a small group they find it easier to talk. Get trainees to work on their own.
- **BUZZ GROUPS** are mini-groups made up of two people sitting beside each other in the circle. If there are only two people, everyone has to talk.
- **CASE STUDIES, CRITICAL INCIDENTS, and ROLE PLAYS** will be used to present real problems from the field as a focus for analysis and problem solving.
- **PRACTICE SESSIONS** will give trainees a chance to try out the skills e.g. going on a guided walk, collecting data, giving a presentation, leading a discussion, etc.
- **STOP-START FACILITATION PRACTICE** is a technique for practising facilitation skills. Participants take turns as the facilitator. Anyone can stop the facilitation at any point to make comments or take over the facilitation role.
- **LOCAL LANGUAGES** will be used as much as possible in the training so that Extension Workers (EWs) practice in the language they will be using in the villages.
- **WARMUP GAMES AND SONGS** will be used to loosen people up and create a spirit of learning, build a feeling of community, and create energy for sessions.
- **BE A GOOD MODEL!** The way you teach EWs will influence the way they teach the community. The more you tell them, the more they will tell the communities – but the more you ask questions and encourage them to talk and do their own thinking, the more they will use the same approaches in the community. **Participation at all levels builds sustainable results.**

Sample training timetable

A sample timetable of the CBM O&M refresher training is given in the Tool Kit. It is based on a two-day training schedule, however, this timetable is only for reference purposes. You should adjust it to suit the needs of the communities based on the identification of O&M issues and availability of the financial and human resources of each district.

References

Ministry of Water Development (1999), Trainer's Guide for Extension Worker Training

Module 2: Financial Management

Introduction

According to the National Water Policy, operation and maintenance costs for water supply system should be covered by full cost-recovery. To achieve this objective one of the key important issues is to properly manage the financing of the water supply service.

The VHWC/WPC as a managing body of the water supply facility at the community level, one of its most important jobs is making sure that the water supply service brings in enough money to cover the full costs of operation and maintenance now and in the future.

Full cost recovery can only be achieved with cost-reflective tariffs. At present, the water tariff is determined without reference to cost estimates; it should be based on the cost of operations and maintenance, rehabilitation and eventual replacement of the water supply system.

This module will enable the participants to understand aspects of financial management for sustainability of their water supply systems. It will also help participants to know and understand how water tariffs are set up and how to manage money.

Objectives

By the end of the module, participants should be able to:

1. Explain the importance of full cost recovery
2. Demonstrate the tariff setting and record keeping

Content

The module covers the following sessions:

Session 1: General principles of financial management

Session 2: Tariff setting

Session 3: Accounting and book keeping

Session 4: Promotion Materials for the Promotion of Regular Payment of Water Fees

Session 1: General Principles of Financial Management

Introduction

This topic will provide general principles of financial management including the key factors in community financial management.

Learning Objectives

By the end of this session, participants will be able to describe the general principles of financial management

Content

General Principles of Financial Managements

Activity 2.1

Step 1

Facilitator asks participants to brainstorm critical factors for financial management

Step 2

Facilitator consolidates the discussions and presents the key strategies for financial management

Key questions

Question A: “Why do communities have to raise funds under the CBM programme? How will the money be used?”

Question B: “What are different ways of raising funds for O&M?”

Question C: “How would you help WPC determine the amount of money to be collected per individual/household and the frequency of collection?”

Question D: “What problems might the WPC face when raising funds?”

Question E: “How can the WPC ensure that the community trusts the WPC’s management of money – so that they will be encouraged to pay on a regular basis?”

Question F: “How can the WPC organise safekeeping of money?”

Question G: Who could be exempted from payment?

Question H: What is the role of the village headman towards the water point?

Key Strategies

Cost-recovery:

Advocating for cost-recovery principles in the operation and maintenance of rural water and sanitation services

Source: National Water Policy. 2006. MoWDI

Cost sharing:

Communities contribute to the capital cost (up front contributions in cash) of water supply facilities to demonstrate a sense of ownership of their ability to cover costs; government or External Support Agencies (ESAs) provide most of the funds for the capital cost (at a basic level);

Communities cover 100% of operation and maintenance costs.

Source: Water Supply and Sanitation District Operation Manual, July 2010, MoWDI

Box 1: Difficulty of cost recovery

One reason why cost recovery is not achieved is because the **responsibility for setting the price of water is given to the villagers**, in keeping with the prevailing ideology of participation and bottom-up decision-making.

This issue demonstrates the clash of bottom-up demand responsiveness with top-down instruction, in this instance the former is less pragmatic with respect to long-term financial sustainability of improved schemes than the latter.

- Participation is now the orthodoxy in mainstream development practice, and while important in some circumstances, it also has its limits. Without possession of relevant information and skills, the decisions made by villages are likely just to reflect the opinions of the facilitator. If so, to call this 'choice' is misleading. It does not capture the role of the implementing agency in the decision, and therefore can absolve the agency of responsibility for its consequences.
- Either implementing agencies accept their role in the decision-making process, and strive to deliver objective and independent advice through their facilitation, and provide on-going support after completion of the project. Or they must allow communities to find their own way through a process of experimentation and trial and error, which would require considerable time and a rethink of what is acceptable when it comes to the quality of a rural water supply.

Source: Management for Sustainability, Practical lessons from three studies on the management of rural water supply schemes, WaterAid Tanzania, June 2009

Key Factors in Community Financial Management

Proper management of funds will ensure that facilities operate sustainably and create trust at the community level. The following are some of the key factors to be considered in community financial management:

Key factors	Contents
Accountability	Handling of funds should be as transparent as possible to build trust in the management of their funds. Bank statements of the water supply financial account should be available for people to

Key factors	Contents
	see. An independent committee of user representatives should be established to audit the accounts.
Accurate costing	<p>Accurate estimation of cost of activities should be worked out. This is important because it will give realistic costs for budgeting and tariff setting. The following costs should be considered:</p> <ul style="list-style-type: none"> •Personnel – management, technical, administrative staff, caretakers, operators, etc. •Materials and spare parts •Transport •Private contractors – repairs, rate of collection, private artisans •Other expenses – office and administrative overheads such as stationary, bank fees, etc.
Collection of payments	Contributions should be collected when people are able to pay and may therefore be irregular. The method of collection should not be disproportionately costly.
Fund administration	The administration of funds requires issuing of receipts for payments and expenditure and careful keeping of records.
Financial and administrative skills	The administration of funds will require men and women with administrative skills. Retired officers have some administrative skills which can be utilized in the communities. Women have shown to be good treasurers.

Source: Implementation Manual For Piped and Point Water Supply Systems, July 2010, MoWDI

References

Ministry of Irrigation and Water Development (2006), National Water Policy

Ministry of Irrigation and Water Development (2010), Water Supply and Sanitation District Operation Manual

Ministry of Irrigation and Water Development (2010), Implementation Manual For Piped and Point Water Supply Systems

Session 2: Tariff Setting

Introduction

The most important job for the WPC is regular provision of safe drinking water on behalf of the beneficiaries. If the water supply system does not have the resources to cover the full cost of producing and delivering water, the system won't be sustainable. As a result the beneficiaries will be frustrated and may prefer to go back to unsafe traditional sources of water.

Sustainable service requires a financial system which is able to pay timely repairs and eventually replace the facility at the end of its life expectancy.

This session will equip participants with knowledge on how to set a tariff for deep well equipped with a Afridev handpump.

Learning Objectives

By the end of this session, participants should be able to:

1. Understand the definition of water tariff
2. Describe each step(s) to be followed when setting a water tariff

Tool Kit

Tool 4: Tariff Setting Booklet (Afridev Handpump Version)

Content

Definition of water tariff

Activity 2.2

Step 1

Facilitator asks participants to explain their experience in setting a water tariff and the contribution amount when repairing their borehole. (i.e., divide the cost of spare parts and payment to AMs by the number of households.

Step 2

Facilitator asks participants to split up into buzz groups to define a water tariff.

Step 3

Facilitator consolidates responses and defines a water tariff.

Definition of water tariff

It is a functional cost at which water services are provided to the beneficiaries (NWP, 2005).

Setting up a Tariff

Activity 2.3

Step 1

Facilitator asks participants to brainstorm the costs of spare parts and a full Afridev handpump set and how such costs can be recovered.

Step 2

Facilitator asks participants to discuss in groups how to react to what can happen if communities protest against water tariff.

Step 3

Facilitator consolidates responses from group work.

Step 4

Facilitator provides an example on how to set a water tariff.

Principle

Tariff setting is based on full cost recovery which is included in O&M cost plus replacement cost of pumping equipment where the life expectancy is **around 15 years**. This example shows the Afridev hand pump case but the same calculation could be used for other types of technologies.

Example

Number of beneficiaries:		100 Households
Cost of supplying water in life span (15 years):		
1. Replacement costs for hand pump spare parts		MK 1,200,000
2. Transportation costs for procurement of spare parts		MK 15,000
3. Cost for preventive maintenance contract with Area Mechanic		MK 45,000
4. Replacement costs of complete Afridev handpump		MK 150,000
5. Construction costs for fence and soak away pit		MK 90,000
		MK 1,500,000
<hr/>		
Annual average cost of one water point	$MK 1,500,000 \div 15 \text{ years} =$	MK 100,000
Annual average cost per household	$MK 100,000 / 100 =$	MK 1,000
Monthly average cost per household	$MK 1,000 \div 12 \text{ months} =$	MK 84

Note: The above example does not consider price increases in each cost.

Steps in setting up a tariff

Costs need to be identified, estimated and analysed, and communities should be informed in order to be fully aware of the implications in choosing a particular technology.

- Step 1: List all O&M activities needed, and their frequency
- Step 2: According to each activity, list all human resources, materials, spare parts, energy, tools and equipment required.

- Step 3: Estimate the quantity or volume needed for each requirement.
 Step 4: Define the activity cost.
 Step 5: Sum up costs of all activities.
 Step 6: Set the water tariff per household per month

< Step 1 > List all O&M activities needed, and their frequency

It is important to identify the minimum cost on O&M during the life span of the handpump. The assumed cost items are as follows.

No.	Item	Description
1	Replacement costs for hand pump spare parts	Based on the replacement intervals of Afridev wearing parts in "Installation and Maintenance Manual for the Afridev Handpump, revision 2-1007, SKAT" required parts and its quantities through life span of the handpump are estimated.
2	Transportation costs for procurement of spare parts	In consideration of the location between the spare parts retail shop and target community, the transportation costs through life span of the handpump are estimated at least 1 time per year.
3	Cost for preventive maintenance contract with Area Mechanic	WPC is recommended to conclude the preventive maintenance contract with an Area Mechanic whose cost is around MK 4,500 per year currently (as of 2014). So it is estimated through life span of the handpump.
4	Replacement costs of complete Afridev handpump	This is a replacement cost after life span of the handpump. So full set of the handpump cost is estimated.
5	Construction costs for fence and soak away pit	Based on the community choice by refereeing the Module 2, these costs are estimated.

< Step 2 > According to each activity, list all human resources, materials, spare parts, energy, tools and equipment required.

< Step 3 > Estimate the quantity or volume needed for each requirement.

Based on the above table, the assumed cost items on O&M in life span will be set up as shown in the following table.

No.	Description	Replacement time		Necessary Qty (pcs) per time	Lifetime												Total										
		Replacement interval (year)	Replacement time in life time (time)		2014	2015	2016	2017	2018	2019	2020	2021	2022	2023	2024	2025		2026	2027	2028	2029						
A	Spare parts																										
A-1	Fulcrum pin assembly	6.5 year	2 time	1 pc																							
A-2	Hanger pin assembly	6.5 year	2 time	1 pc																							
A-3	Pump head with Pump handle	6.5 year	2 time	1 pc																							
A-4	Rod hanger assembly	1 year	15 time	4 pc																							
A-5	Bearing bush outer	1 year	15 time	4 pc																							
A-6	Bearing bush inner	4 year	3 time	1 pc																							
A-7	Top rod assembly	4 year	3 time	8 pc																							
A-8	Pump rod assembly	2 year	7 time	8 pc																							
A-9	Centralizer	4 year	3 time	8 pc																							
A-10	Riser pipe assembly	4 year	3 time	8 pc																							
A-11	Riser pipe	4 year	3 time	8 pc																							
A-12	Top sleeve	4 year	3 time	1 pc																							
A-13	Flapper	4 year	3 time	1 pc																							
A-14	Centraliser 4"	4 year	3 time	8 pc																							
A-15	Cylinder assembly	6.5 year	2 time	1 pc																							
A-16	Valve body assembly	4 year	3 time	2 pc																							
A-17	O-ring (for brass foot valve)	2 year	7 time	1 pc																							
A-18	Bobbin	2 year	7 time	2 pc																							
A-19	Cap seal (for brass foot valve)	2 year	7 time	1 pc																							
A-20	O-ring	2 year	7 time	1 pc																							
A-21	U-seal	1 year	15 time	1 pc																							
A-22	Gasket	6.5 year	2 time	1 pc																							
	Compression cone	6.5 year	2 time	1 pc																							
B	Complete Aridex Pump	15 year	1 time	1 pc																							
C	Labor charge																										
C-1	Preventive maintenance by Area mechanic	1 year	15 time	1 pc																							
C-2																											
C-3																											
C-4																											
C-5																											
C-6																											
D	Others																										
D-1	Transport cost for procurement of the spare parts	1 year	15 time	1 pc																							
D-2	Construction costs for fence and soak away pit	15 year	1 time	1 pc																							
D-3																											
D-4																											
D-5																											

< Step 4 > Define the activity cost.

Unit price for each item will be surveyed as shown in table which is included for reference purposes.

as of 2013

No.	Description		Price (MK)
A	Spare parts		
A-1	Pump head with Pump handle	Fulcrum pin assembly	3,500
A-2		Hanger pin assembly	2,700
A-3		Rod hanger assembly	4,400
A-4		Bearing bush outer	600
A-5		Bearing bush inner	600
A-6	Pump rods	Top rod assembly	5,100
A-7		Pump rod assembly	3m/piece 7,500
A-8		Centralizer	500
A-9	Rising main	Riser pipe assembly	5,300
A-10		Riser pipe	3m/piece 3,800
A-11		Top sleeve	600
A-12		Flapper	400
A-13		Cetraliser 4" (Rubber, for 4" casings)	600
A-14	Pump Cylinder	Cylinder assemble	35,600
A-15	Plunger and Foot valve	Valve body assembly	6,200
A-16		O-ring (for brass foot valve)	Nitrile rubber, for Brass Foot valve 200
A-17		Bobbin	Nitrile rubber, for all Plunger & Foot valve types 300
A-18		Cup seal (for brass foot valve)	Nitrile rubber, for Braes Foot valve 300
A-19		O-ring	Nitrile rubber, for all Plunger & Foot valve types 200
A-20		U-seal	Nitrile rubber, for Plastic Plunger 300
A-21	Other parts	Gasket	1,200
A-22		Compression cone	1,200
B	Complete Afridev Pump		150,000
C	Labor charge		
C-1	Preventive maintenance by Area mechanic	1 time / year	3,000
C-2			
C-3			
C-4			
C-5			
C-6			
D	Others		
D-1	Transport cost for procurement of the spare parts	At least 1 time / year	1,000
D-2	Construction costs for fence and soak away pit	ex. Brick fence and pit with stones	90,000
D-3			
D-4			
D-5			

< Step 5 > Sum up costs of all activities.

According to step 3 and step 4, all of the costs of O&M activities can be calculated as shown in the table below. However since this way does not consider the price escalation of each spare part during its life span, these results are considered to be a rough estimate.

Note:

If the life-span costs should be estimated more accurately, it is considered the price escalation for each cost using price consumer index (PCI) which is announced annually by the National Statistical Office (NSO) in Malawi. This data is able to be accessed via NSO's web page.

as of 2013

No.	Items		a	b	c = a x b	
			Unit Price (MK)	Necessary quantity in life-span (15 years)	Total amount in life-span *1 (MK)	
A	Spare parts					
A-1	Pump head with Pump handle	Fulcrum pin assembly	3,500	2	7,000	
A-2		Hanger pin assembly	2,700	2	5,400	
A-3		Rod hanger assembly	4,400	2	8,800	
A-4		Bearing bush outer	600	60	36,000	
A-5		Bearing bush inner	600	60	36,000	
A-6	Pump rods	Top rod assembly	5,100	3	15,300	
A-7		Pump rod assembly	3m / piece	7,500	24	180,000
A-8		Centralizer		500	56	28,000
A-9	Rising main	Riser pipe assembly	5,300	24	127,200	
A-10		Riser pipe	3m / piece	3,800	24	91,200
A-11		Top sleeve		600	3	1,800
A-12		Flapper		400	3	1,200
A-13		Centraliser 4"	(Rubber, for 4" casings)	600	24	14,400
A-14	Pump Cylinder	Cylinder assemble	35,600	2	71,200	
A-15	Plunger and Foot valve	Valve body assembly	6,200	6	37,200	
A-16		O-ring (for brass foot valve)	Nitrile rubber, for Brass Foot valve	200	7	1,400
A-17		Bobbin	Nitrile rubber, for all Plunger & Foot valve types	300	14	4,200
A-18		Cup seal (for brass foot valve)	Nitrile rubber, for Braes Foot valve	300	7	2,100
A-19		O-ring	Nitrile rubber, for all Plunger & Foot valve types	200	7	1,400
A-20		U-seal	Nitrile rubber, for Plastic Plunger	300	15	4,500
A-21		Other parts	Gasket	1,200	2	2,400
A-22	Compression cone		1,200	2	2,400	
B	Complete Afridev Pump		150,000	1	150,000	
C	Labor charge					
C-1	Preventive maintenance by Area mechanic	1 time / year	3,000	15	45,000	
C-2						
C-3						
C-4						
C-5						
C-6						
D	Others					
D-1	Transport cost for procurement of the spare parts	At least 1 time / year	1,000	15	15,000	
D-2	Construction costs for fence and soak away pit	ex. Brick fence and pit with stones	90,000	1	90,000	
D-3						
D-4						
D-5						
Total O&M cost					979,100	

*1: This amount is not considered the price escalation of spare parts.

<Step 6> Setting the water tariff per household per month

Considerations for Choosing a Rate Structure

Water tariff can be structured in several different ways and there are a number of things to consider, in addition to recovering costs, when selecting the best tariff structure for your system and your beneficiaries.

For the point water source system such as borehole with equipped Afridev handpump, flat rate/fixed rate is normally appropriate because it is simpler. Under this tariff structure, beneficiaries pay the same amount regardless of how much water they use.

Annual average cost

Annual average cost is calculated as shown below.

$$\begin{aligned}\text{Annual average cost} &= \text{Total amount in life span} \div \text{life span} \\ &= 100,000 \div 15 = 6,667 \approx \text{MK 7,000} \\ \text{Total amount in life span:} & \text{MK 979,100} \approx \text{MK 100,000 (From above table)} \\ \text{Life span:} & 15 \text{ years}\end{aligned}$$

Annual household tariff (annual household cost)

Annual household tariff is calculated as shown below.

$$\begin{aligned}\text{Annual household tariff} &= \text{Annual average cost} \div \text{number of the beneficiaries by households} \\ &= 7,000 \div 100 = \text{MK 700} \\ \text{Annual average cost} & \approx \text{MK 7,000 (From above)} \\ \text{Number of the beneficiaries by households:} & 100 \text{ HHS}\end{aligned}$$

Monthly household tariff

Annual household tariff is calculated as shown below.

$$\begin{aligned}\text{Monthly household tariff} &= \text{Annual household tariff} \div 12 \text{ month} \\ &= 700 \div 12 = 58 \approx \text{MK 60} \\ \text{Annual average cost} & \approx \text{MK 7,000 (From above)}\end{aligned}$$

Session 3: Accounting and Book keeping

Introduction

Accounting and book keeping involves the keeping of records for each transaction for the purposes of transparency, accountability and reporting. Each transaction should be tracked to a particular activity. Accounting and bookkeeping also help in preparation of financial reports and facilitates smooth audits.

This session will equip the participants with knowledge and skills of financial reporting, book keeping and account management.

Learning Objectives

By the end of this session, participants should be able to:

1. Facilitate problem solving discussions with the community related to problems in collecting and managing money
2. Advise the WPC/VHWC on how to keep simple records

Tool Kit

Tool 5: Form of User Contribution Book

Tool 6: Form of Cash Book

Content

Problems in collecting and managing money

Activity 2.4

Step 1

Facilitator asks participants to discuss what each community has done in terms of money – e.g. raising funds, record keeping, banking and reporting to community

Step 2

Facilitator consolidates responses.

Solutions to general problems

Problems	Cause	Solutions
People refuse or unable to contribute	Poverty or poor harvest; past experience creates mistrust in WPC; poor timing of collection	Involve community in deciding method of collection; regular financial reports to community
Money stolen or misused	No or poor record-keeping; no checking by office bearers; personnel problems (treasurer)	WPC to enforce record-keeping; financial report at each meeting; bylaws/rules against misuse
Delays in payments to bank/treasurer	Too many money collectors; inadequate record-keeping skills;	Limit the number of collectors; improve record-keeping skills;

Problems	Cause	Solutions
	distance to banks	bank money soon after collection
Money used for other purposes	Pressure to use money for other projects or emergencies; long distance to banks	Resist pressure to use money for other purposes
No or poor record keeping	Few people who are literate to do accounts; lack of record-keeping skills	Train WPC in record-keeping; get help from local teachers

Source: Trainer's Guide for Extension Worker Training, 1999, Ministry of Water Development

How to store the money

Activity 2.5

Step 1















Facilitator asks participants to discuss where money will be stored.

Step 2

Facilitator consolidates responses.

General methods

Generally, a community has two options of places to store money: in a bank account or in a community cash box. The water committee decides which option to choose by presenting the advantage and disadvantage of each.

Method	Advantage	Disadvantage
Banks	<ul style="list-style-type: none">  Safe place  Interest bearing  Bank statements  Help from the bankers  Easy to track money  Credibility for community 	<ul style="list-style-type: none">  May require travel from rural areas  Possible restrictions on withdrawals  Money not immediately available in case of emergency
Community cash box	<ul style="list-style-type: none">  Accessible  Money can be counted easily  Community operated 	<ul style="list-style-type: none">  Not very safe  Requires careful accounting by treasurer  Temptation to spend on other things

Record-keeping

Activity 2.6

Step 1

Facilitator asks participants to brainstorm why record keeping is important.

Step 2

Facilitator consolidates responses.

Step 3

Facilitator introduces the sample format for record keeping.

Step 4

Facilitator asks participants to practice filling out the sample format.

Type of financial record keeping

Table 3: Sample of the financial record keeping

Type of book	Description
Users contribution book	It is a book which contains information about the community members who have contributed money for O&M of the water supply facilities.
Cash book	It is a book which contains information about all financial transactions, including income (cash in, for instance the contributions by community members) and expenditure (cash out, for instance money paid for purchasing a spare part and maintenance contract fee with area mechanics)

a. Users contribution book

Note: Translate the manual into the local language for easy understanding by the communities.

Sample template for user contribution book is provided as shown below.

Table 4: Sample template of user contribution book

TA: Zulu		Village: Mtanga															
Borehole No.: Mtanga 1		Date: 1/1/2015															
													Annual contributions per HH: 1,200 MSc				
User No.	Name	a. Balance for last year (2014)	5 Contribution paid in												b. Sub-total	c. Balance for this year (2015)	d. Total Balance (last and this year)
			2015														
			JAN	FEB	MAR	APR	MAY	JUN	JUL	AUG	SEP	OCT	NOV	DEC			
			e = b - c												d = a + c		
1	Ms. Phiri	0	100	100	100	100	100	100	100	100	100	100	100	100	1,200	0	0
2	Mr. Mphonda	-200	0	0	0	0	0	300	400	100	100	50	50	0	1,000	-200	-400
3	Mr. Mlangiza	-500	0	0	0	0	0	200	200	200	200	200	200	200	1,200	0	-500
4	Ms. Tembo	0	0	100	100	100	100	200	200	100	100	100	100	0	1,200	0	0
5	Ms. Mbewe	0	100	100	100	100	100	100	100	100	100	100	100	100	1,200	0	0
6	Mr. Zulu	-100	100	100	100	100	100	100	100	100	100	100	100	100	1,200	0	-100
7	Mr. Richard	-100	50	50	50	50	300	300	200	100	100	50	0	1,300	≠100	0	
8																	
9																	
10																	
11																	
12																	

Sample template is organized into seven main items. Details of each item are described as shown in the below table.

No.	Item	Details
①	Basic information on water supply facility	User contribution book is basically updated on an annual basis. The date is recorded when WPC members fill out first information such as user names and basic information.
②	Annual contribution per household (Annual water tariff)	WPC members with beneficiaries should review the water tariff at least once a year. After that, WPC members fill out the annual total amount of user's contributions.
③	User names (beneficiary)	WPC members review the registrations of beneficiaries at least once a year. After that, WPC members fill out all of the names of regular users of the water point.
④	Balance for last year	This is a payment record for last year . This figure is extracted from last user contribution book basically. If the users did not meet the requirement for the payment, shortage of the figures should be filled out in this column-a.
⑤	Monthly contribution records	This is a payment record for this year from January to December. After payment by each user, WPC members should fill out the contribution figure. And the total amount for this year which is described in column-b should be calculated at the end of this year.
⑥	Balance for this year	This is a balance between annual water tariff and payment for this year. The formula of the calculation is as follows. Formula = (Total contributions for this year) - (Annual contribution per household) = ⑤ - ②
⑦	Total Balance	This is a balance including payment for this year and last year. The formula of the calculation is as follows. This figure is transcribed into the next user contribution book. Formula = (Balance for last year) – (Balance for this year) = ④ + ⑥

b. Cash book (should be simple and user friendly for WPCs, i.e.: records of income and expenditures and dates)

Sample template for cash book is provided as shown below.

Table 5: Sample template of cash book

T.A: Zulu		Village: Mtanga	
Borehole No: Mtanga 1		Date: 1/1/2015	

② Date	③ Payer	④ Payee	⑤ Item	⑥ a. Cash in (+)	⑦ b. Cash out (-)	⑧ c. Balance c = a - b
1/1/2015	Users	Ms. Phiri	User contributions for January 2015 (50 users)	5,000	-	5,000
15/1/2015	Ms. Phiri	Mr. Zulu (AM)	Preventive contact for O&M	-	3,000	2,000
20/1/2015	Ms. Phiri	Retail shop owner	U-seal x 2 units, Bobbin x 2 units	-	1,000	1,000

Sample template is organized into eight main items. Details of each item are described as shown in the below table.

No.	Item	Details
①	Basic information on water supply facility	Cash book is recorded when there are any payments and deposits related to water supply services. The date is recorded when a WPC member fills out the first information on each page.
②	Date	The date of the transaction
③	Payer	Name of the person or organization who paid money
④	Payee	Name of the person or organization who received money
⑤	Item	Name of the payment items and quantities
⑥	Cash in	This is income which is received by the WPC members for ensuring the water supply services
⑦	Cash out	This is an expenditure which is spent by the WPC members for ensuring the water supply services.
⑧	Balance	The amount left after adding or deducting the last amount

Session 4: Promotion Materials for the Promotion of Regular Payment of Water Fees

Introduction

This topic will provide information on the use of two types of promotion materials; “Village Head’s Consensus Form for Payment of Water Fee” and “Promotion Song: Water is Life” as tools to facilitate community involvement and participation.

Learning Objectives

By the end of this session, participants will be able to describe and understand how to use two promotion materials for regular payment of water fees.

Tool Kit

Tool 7: Promotion song for payment of water fees (Water is Life)

Tool 8: Village head’s consensus form for promotion of regular payment of water fees

Content

Village Head’s Consensus Form for Payment of Water Fees

Activity 2.7

Step 1

Provide the Village Head’s Consensus form to the participants and discuss about the content of the form

Step 2

Ask participants the name of influential people in their village, i.e., village head, natural leaders, etc. and let them decide on who should be signing the consensus form

Step 3

Fill in all other information required in the Consensus Form

Step 4

Discuss who should keep the Village Head’s Consensus form and on which occasions to display the forms. For example, the form could be displayed during village meetings, in a tree near the borehole, on the day of water fee payment, etc.

Khalani a moyo wathanzi pakumwa madzi abwino a pamjigo
Lipilani ndalama zokonzera mjigo



Ine, _____ wa m'mudzi
 wa _____, ndikulongeza kuti mudzi wathu
 udzakhalala wathanzi pakumwa madzi abwino nithawi zote polipira ndalama
 zokonzera injigo nithawi ndi nthawi.

(Dina la Mfumu) _____ (Sani) _____ (Taka) _____

Po mase pa:

(Dina la wapangano wa WPC) _____ (Sani) _____ (Taka) _____
 ndi _____

(Dina la mbosi) _____ (Sani) _____ (Taka) _____

MGIGO: MUDZI:

Figure 2: Village Head’s Consensus Form for the promotion of regular payment of water fees

Purpose of the Village Head’s Consensus Form

The form was developed to obtain the commitment of the village head, influential person in the village and the chair of the WPC/VHWC in promoting regular payments of water fees by all villagers to be used for the O&M of their water points in order to have continued access to safe water.

Content and Details of the Consensus Form

The Village Head’s Consensus Form contains the following information:

- Key message “Have a healthy life, drink safe water from the borehole always by paying for maintenance costs”
- Village Head’s endorsement
- Name of the village
- Identification of the water point
- Date, name and signature of the village head
- Date, name and signature of the influential person
- Date, name and signature of the chair of the WPC/VHWC
- Target audience: women, men and children

Promotion Song for Payment of Water Fee “Water is Life”**Activity 2.8****Step 1**

Provide the script of the promotion song “Water is Life” to the participants and discuss about the content of the song

Step 2

Play the song and practice at least two times

Step 3

Ask participants if there are musicians, bands, choirs in the village and whether they can prepare a song for the promotion of regular payment of water in their own traditional tune. Allow them to suggest key messages and practice their song

Step 4

Discuss about effective events and times to sing the promotion song so that the message is passed on to the whole community. Some villagers use the promotion song in village meetings, village bank meetings, on the day of water fee payment, when conducting development work such as moulding bricks and construction of sanitary facilities, etc.



Figure 3: CD with promotion songs provided in the Tool Kit

↓
SONG 1: MADZI NDI MOYO↵

VERSE 1↵
 Ayoyoyooo ku mudziko yoyoyooo↵
 Ukhondo wabwino umayamba ndi madzi↵
 Tiyenera kumwa madzi olongosoka↵
 Ichi ndi chifukwa chake Boma la Malawi↵
 Likulimbikitsa kusamala mijigo↵
 Koma izi kuti zitheke komanso zipitirire↵
 Ndi udindo wa tonse kutenga mbali↵
 Inu mafumu, village band, ma volantiya↵
 Mukhale maso. Onetsetsani kuti aliyense ↵
 Akusonkha kangachepe nthawi zonse↵
 Ndalama imeneyi ndiyothandiza kuti↵
 Mjigo ukaonongeka tizitha kukonzaso↵
 ↵

CHORUS↵
Lead: **Madzi ndi moyo**↵
 All : Tiwasamale↵
Lead: **Tilimbikitsane**↵
 All : kumwa madzi aukhondo↵
Lead: **Ndalama zokonzera**↵
 All : Tizipereka↵
Lead: **Kuti mjigo ukawongeka**↵
 All : Tizitha kukonzanso↵
 ↵

VERSE 2↵
 Anthuni kupewa kumaposa kuchiza↵
 Nkhanga zinapangana kusanapse↵
 Khalani athanzi pomwa madzi a bwino a pa mijigo↵
 Lipilani ndalama zokonzera mujigo↵
 Ubwino wina wa madzi a pa mijigo↵
 Kuphikira ndiwo sizichedwa kupsa↵

Awuzeni awo awuzenso ena↵
 Tisathawe udindo popereka ndalama↵
 Poti tikadwala tidzaononga↵
 Ndalama zambiri komanso nthawi↵
 Lipilani inu ndalama Kuti muzimwa madzi a bwino↵
BACK TO CHORUS↵
 ↵

SOME TRADITIONAL TUNE↵
 ↵
Lead Imwani madzi abwino↵
Back **Tizimwa madzi abwino**↵
Lead Madzi a pa mijigo abwino↵
Back **Madzi a pamjigo abwino**↵
Lead Imwani madzi↵
Back **Abwino, abwino aa**↵
Lead Madzi a pamjigo↵
Back **Abwino, abwino aa**↵
Lead Kuti mukhale athanzi↵
Back **Kuti mukhale athanzi**↵
Lead Kuti mukhale ↵
Back **Athanzi, athanzi aa**↵
 ↵

↵
CHORUS↵
Lead: **Madzi ndi moyo**↵
 All : Tiwasamale↵
Lead: **Tilimbikitsane**↵
 All : kumwa madzi aukhondo↵
Lead: **Ndalama zokonzera**↵
 All : Tizipereka↵
Lead: **Kuti mijigo ikawongeka**↵
 All : Tizitha kukonzanso↵

Figure 4: Scripts of the promotion song “Water is Life”

Purpose of the Promotion Song “Water is Life”

The promotion song was developed to be used to pass key messages to the villagers on the importance of regular payment of water fees. It was designed to be:

- Attractive: so that it pulls people in
- Uses local language: so that people feel it concerns them
- Repetitive: so that messages are retained
- Easy to understand: so nobody gets confused
- Participatory: so exchange of views is most effective
- Provocative: so that they are memorable and discussed

Details of the Promotion Song “Water is Life”

- Singer: Skeffa Chimoto
- Target Audience: Men, women and children
- Key message “Have a healthy life, drink safe water from the borehole always by paying for maintenance costs”
- Specific features: includes whistling to promote regular payment of water tariff. The whistling alone or the song could be used when WPC/VHWC members are collecting water fees.

Module 3: Water Point Sanitation and Hygiene

Introduction

Sanitation is defined as the science for preventing certain communicable diseases¹ by the provision, availability and use of structures that facilitate hygiene. Consistent and proper use of the sanitation facilities is termed hygiene.

Water Point Sanitation is the provision of facilities/structures that promote sanitation at the water point such as aprons, drainage channels, soak away pits, irrigation channels, washing slabs and fences. Water Point Sanitation is important because it prevents waste water stagnation and seepage contamination of boreholes that may lead to diarrhoea and mosquito and bilharzia-snail breeding that could result in malaria and bilharzia cases.²

This module will impart knowledge and skills regarding the potential sources of pollution in the borehole surroundings, different types of water point sanitation facilities/structures for making informed choices, and tips for encouraging beneficiaries in maintaining hygienic borehole surroundings.

Learning Objectives

By the end of this module, participants should be able to:

1. Identify problematic situations around the borehole and possible solutions for maintaining hygienic borehole surroundings
2. Be familiar with the different types of water point sanitation facilities/structures and make informed choices of sanitation facilities required
3. Describe and use the promotion materials for water point sanitation
4. Understand the methodologies for using the promotion materials
5. Train EWs or WPC/VHWC members, influential person and village headman on how to encourage beneficiaries to maintain a hygienic borehole surroundings

Content

The module covers the following sessions:

Session 1: Identifying the sources of contamination of water points

Session 2: Decision-making for the selection and construction of appropriate water point sanitation facilities/structures

Session 3: Promotion materials for water point sanitation

Session 4: General principles of hygiene

¹ Some communicable diseases prevented by using sanitation facilities (i.e., following proper hygiene) are diarrhoea, cholera, dysentery, malaria, bilharzia and other worm infestations, hepatitis B, poliomyelitis, scabies, worm and eye infections.

² Malawi PHAST for improved Rural Water Supply, Sanitation, Hygiene and Health. Training and Implementation Manual, July 2001, pp. 8-9.

Session 1: Identifying the Sources of Contamination of Water Points

Introduction

This session will help participants in identifying actual and potential sources of contamination of water points and provide tools for the selection of appropriate actions for avoiding water contamination at the source.

Cleanliness in the area of the water point is an important factor. If the surrounding area is not kept clean and free of animals, debris waste and stagnant water, the water point could become a hub for the transmission of many infectious diseases. In this respect, the ability of the community to manage the system and ensure regular cleaning of the water point is vital.

If the area around the well is allowed to become dirty, and waste and stagnant water is allowed to accumulate, it will become a source of infection for other users. Standing in bare feet in stagnant water or mud is a serious health risk in the tropics since the open water provides an ideal breeding ground for many types of parasites and/or disease carrier. Awareness of the direct links between hygiene and water must start at the collection point, otherwise the possible benefits from an improved water supply will be lost.

Learning Objectives

By the end of this topic, participants will be able to:

1. Identify sources of water point contamination
2. Select appropriate actions to avoid water source contamination
3. Come up with an action plan including responsible parties and timeframe

Tool Kit

Tool 9: Sanitary Inspection Form

Tool 10: Visual Education Materials

Content

Identify sources of water point contamination

Activity 3.1

Step 1

Conduct a sanitary inspection of a water supply by taking the participants to the water point to visually identify the actual and potential sources of contamination (latrine, bath-shelter, animal cage, grave yard, cultivation, defects in concrete apron and drainage channel, pool of stagnant water, etc.).

Step 2

At the water point, the facilitator can explain the sanitary inspection questionnaire and let participants record their answers in their own survey form. After the survey, let them score and evaluate the risk of contamination.

Step 3

Measure the distance of sources of contamination to the head of the hand pump which should be located at least 30 m from the head of the hand pump if it is a deep well (Afridev hand pump) or at least 100 m in the case of shallow wells (Malda hand pump) and prepare the drawing in the second page of the Sanitary Inspection Form. Is the 30m away from the water point for all types of soils and terrain? The answer was this was an average, if you do more than the better.

Definition

Sanitary inspections should be carried out in all water point/facilities used for drinking water on a regular basis. Sanitary inspection can be carried out by communities, especially the WPC/VHWC with some facilitation from the HSA or WMA using a simple, clear report form. These forms consist of a set of questions which have “yes” or “no” answers. These questions are structured so that “yes” answers indicate that there is a risk of contamination and “no” answers indicate that the particular risk is absent. Each “yes” answer scored one point and each “no” answer scores zero points. At the end of the inspection the points are added up, and the higher the total the greater the risk of contamination.

Sanitary Inspection of a Hand Pump

Date/Time: _____ Weather: _____ Name of Enumerator: _____

Site No.: _____

Village name: _____ Tk.: _____ HC: _____

Group/village name: _____ Location (site) name: _____

GPS coordination: _____ Southing: _____ Easting: _____

HSA in Charge: _____ Name: _____ Cell No.: _____

Village Head Man: _____ Name: _____ Cell No.: _____

Chairperson of WPC/VHWC: _____ Name: _____ Cell No.: _____

Influential person: _____ Name: _____ Cell No.: _____

Code	Specific Information	Risk		Comments
		YES	NO	
1	Does the hand pump surrounding need cleaning? <input type="checkbox"/> Grassy <input type="checkbox"/> Rubbish and animal excreta in the surrounding. <input type="checkbox"/> Dirty and slippery floor <input type="checkbox"/> Stagnant water. <input type="checkbox"/> Other: _____			
2	Is there a latrine within 30 meters of the well?			
3	Is the nearest latrine on higher ground than the well?			
4	Are there any sources of pollution within 30 meters of the well? If yes, what sources? <input type="checkbox"/> Latrine <input type="checkbox"/> Refuse pit <input type="checkbox"/> Bath shelter. <input type="checkbox"/> Cultivation <input type="checkbox"/> Animal cage <input type="checkbox"/> Other: _____			
5	Is the hand pump drainage channel faulty (e.g. broken, permitting stagnant water)?			
6	Is there inadequate fencing around the installation, which would allow animals in?			
7	Is the cement floor less than 1 meter radius all around the head of the hand pump?			
8	Are there any cracks on the cement floor around the water point?			
9	Is the hand pump loose at the point of attachment to base (which could permit water to enter the casing)?			
10	Are the walls of the well inadequately sealed at any point for 3 meters below ground level?			

Recommendations: _____ Implementation Date: _____ Responsible Person/Group: _____

Schematic Drawing (Location of Sources of Pollution and Distance to the Head of the Hand Pump)



Sanitary Inspection Form for Hand pumps

Schematic Drawing of location of Sources of Contamination and Distance to the Head of the Hand pump

Selecting appropriate actions to avoid water source contamination

Activity 3.2

Step 1

Facilitator asks participants to discuss results of the sanitary inspection questionnaire and choose the visual education material illustrations that correspond to the problems identified.

Step 2

Facilitator uses the visual education material to suggest some local solutions that can be considered to improve their water point.

Step 3

Participants to discuss and plan a village meeting with the support of EWs to discuss appropriate remedial action(s) with the whole community to improve or protect their water point.

Step 4

Prepare an action plan with recommendations, responsible person/group and timeframe for filling out the table in the sanitary inspection form.

The results of the sanitary inspection and the remedial actions that need to be taken to improve conditions should be discussed with the community. In small water supplies it is often possible for community members to carry out most of the inspections themselves using a standard form. Below are snapshots of the seven visual education materials that can be used in Activity 1.2 to suggest some local solutions that can be considered to improve their water point. At the back of the illustration, the facilitator can find additional explanation for the problem and the suggested solutions to the problems in English and Chichewa.

FRONT

BACK

<Card 1>



Material 1: A latrine near a borehole as source of contamination.

ENGLISH:

- 1. TITLE:** A latrine near a borehole as source of contamination.
- 2. PROBLEMATIC SITUATION:** Nearest latrine is less than 30 meters and is on higher ground than water point.
- 3. SOLUTION OR/AND DESIRABLE SITUATION:**
 - > **SOLUTION 1:** Stop using the latrine and relocate it at a safe distance
 - > **SOLUTION 2:** If latrine cannot be relocated, construct a latrine with a septic tank.
 - > **SOLUTION 3:** If latrine cannot be relocated and septic tank cannot be constructed for any reason, the water point should be abandoned for drinking purposes.

CHICHewa:

MINGO OMWU ULI PAKUPI NDI CHIMBUZI NDI GWISO LA MATENDA
 Malivuto omwe angalibe (kufukokera)
 Chimbuzi chomangitsa pakupi ndi Migo pa mtunda wochepa milingo makumi atatu kumunda kwa jigo.

ZOPUNIKA KUCHITA KUTHEZA POTHESA BVUTOLI
 Titye kugvilitza mchito chimbuzi ndi kuzimangira malo esa otalikirana ndi Migo wathu paounda opitira milingo makumi atatu.
 Ngati nyumba yachimbuzi singamuzidwe ndipofunika kulonza njira ndi kukumba dzenje kumasi kwa nyumba ya chimbuzi
 Ngati chimbuzi chitaphere kutamuzidwa nalipo njira yokumba chimbuzi cha madzi itaighelekanso mawitso akanwedwe.

NEEMANIYA
 Chimbuzi ndi mihanjo; otigwirizanako, koma pamayankira kufhala malo zambara mmanja kuti chionekedzi kuti ndi chimbuzi.

<Card 2>

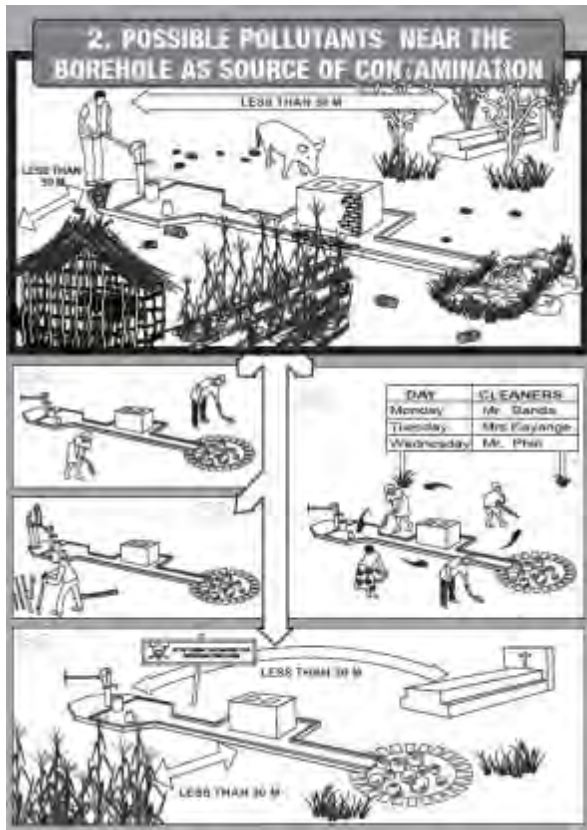

Material 2: Possible pollutants near the borehole as source of contamination

ENGLISH:

1. **TITLE:** Possible pollutants near the borehole as source of contamination.
2. **PROBLEMATIC SITUATION:** The sources of pollution (such as rubbish dumps, animal cage, feces, grazing, grave yard, cultivation) are less than 30 meters
3. **SOLUTION OR/AND DESIRABLE SITUATION**
 - **SOLUTION 1:** Clean the rubbish dumps.
 - **SOLUTION 2:** Remove animal cage, animal dung, grazing around the hand pump.
 - **SOLUTION 3:** If the water points are near grave yard and cultivation is taking place, the water point should be abandoned for drinking purpose.
 - **SOLUTION 4:** Make roaster among users to clean surrounding and platform.

CHICHEWA:

KAMANGIDWE KA APULONI KOMWE KANGABWELETSE CHIOPYSEZO PA DILAWO PATHU CHOMWE CHINGABWERETSE BVUTO

Ngati apuloni yathu ichepa ndi 1 meter kuzungulira Mjigo /dilawo yathu. Komanso ngati popondera pojiga pachepa ndi mamita atatu, kuchokera pa Mjigo/dilawo kapena Apuloni yathu yasweka, kapena ili ndi ming'alu ndi maenje.

NIRA YOTHETSERA BVUTO

Mangani Apuloni yatsopano yotalika ndi meter imodzi kapena kuposera apo, ndi popondera pojiga patalike ndi mamita atatu kapena kuposera apo. Mothandizidwa ndi a eria makaniki ndi a builder a m'mudzi ngati palibe ena.

NDEMANGA

Chithunzi choyamba chikhale choyamambilira
Chithunzi chachiwiri chikhale chomwe chikukonzedwa
Chithunzi chachitatu chikhale chomwe chilli pakati chokonzedwa bwino

<Card 3>

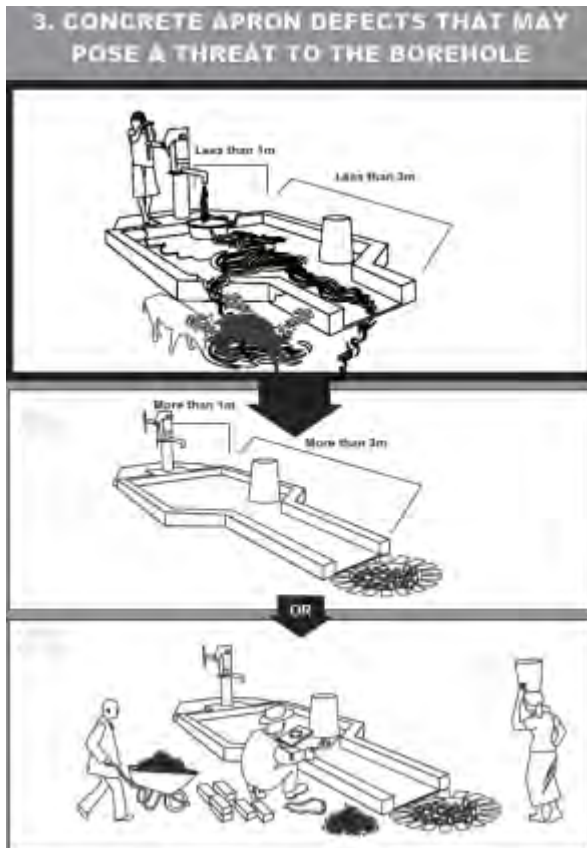

Material 3: Concrete apron defects that may pose a threat to the borehole

ENGLISH:

1. **TITLE:** Concrete apron defects that may pose a threat to the borehole.
2. **PROBLEMATIC SITUATION:** Concrete apron is less than 1 meter around the pump stand and with less than 3 meters of concrete sanitary protection with borehole or the concrete apron is broken, cracks and potholes.
3. **SOLUTION OR/AND DESIRABLE SITUATION**
 - **SOLUTION 1:** Construct a new apron with 1 meter or more long and sanitary protection with 3 meters more long with the support of Area Mechanics and Village Builders.
 - **SOLUTION 2:** Repair existing apron to remove cracks and potholes and improve slope towards drainage.

CHICHEWA:

KAMANGIDWE KA APULONI KOMWE KANGABWELETSE CHIOPYSEZO PA DILAWO PATHU CHOMWE CHINGABWERETSE BVUTO

Ngati apuloni yathu ichepa ndi 1 meter kuzungulira Mjigo/dilawo yathu. Komanso ngati popondera pojiga pachepa ndi mamita atatu, kuchokera pa Mjigo/dilawo kapena Apuloni yathu yasweka, kapena ili ndi ming'alu ndi maenje.

NIRA YOTHETSERA BVUTO

Mangani Apuloni yatsopano yotalika ndi meter imodzi kapena kuposera apo, ndi popondera pojiga patalike ndi mamita atatu kapena kuposera apo. Mothandizidwa ndi a eria makaniki ndi a builder a m'mudzi ngati palibe ena.

NDEMANGA

Chithunzi choyamba chikhale choyamambilira
Chithunzi chachiwiri chikhale chomwe chikukonzedwa
Chithunzi chachitatu chikhale chomwe chilli pakati chokonzedwa bwino

<Card 4>

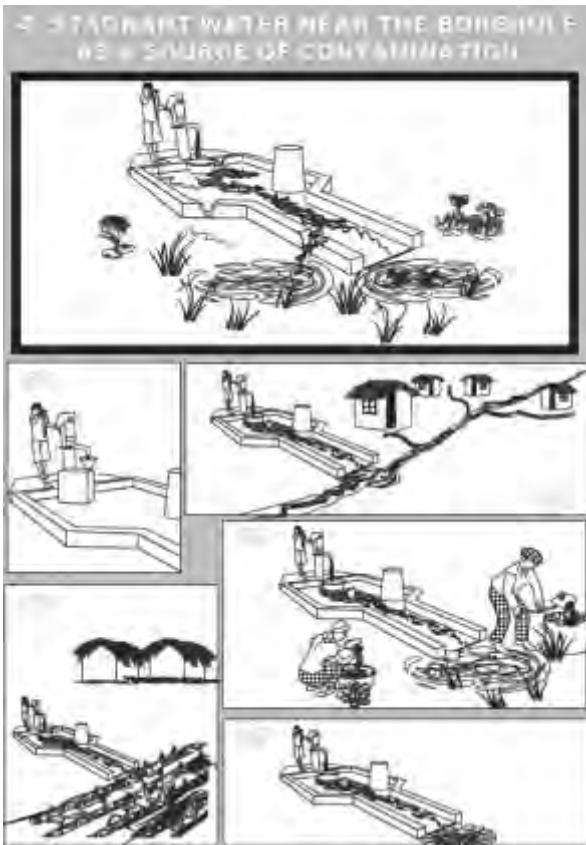

Material 4: Stagnant water near the borehole as a source of contamination

ENGLISH:

1. **TITLE:** Stagnant water near the borehole as a source of contamination.
2. **PROBLEMATIC SITUATION:** Stagnant water sources (pool of water from soak away pits, improper drainage and fish/ duck ponds) are less than 30 meters from water points.
3. **SOLUTION OR/AND DESIRABLE SITUATION**
 - **SOLUTION 1:** Use funnels when jerrycan with small mouths are being used to avoid spill over that can enhance the pool of water, waste water to be minimized.
 - **SOLUTION 2:** Improve drainage so that waste water flows into natural drainage.
 - **SOLUTION 3:** Develop vegetable garden using waste water.
 - **SOLUTION 4:** Remove litter and wash stones in a soak away pit.
 - **SOLUTION 5:** Divert the direct the direction of the soak away pit and drain off the pool of water.

CHICHEWA:

ZITHAPHWI ZOYANDIKANA NDI MJIGO MOMWE ZINGAONONGELE MADZI
Mbuvuto ake: Momwe zithaphwi zimabwelera
 Kutayikira kwa madzi a Mngalande, njira yolakwika yochotsera madzi otayikira pa mjigo ndinso kupeseka
 kwa mayenje a nsomba ndi a bakha malipande osachepera makumi atatu kuchokera pa mjigo.
NIIRA ZOTHETSERA / NIIRA ZOBVOMEREZEKA
Njira yoyamba
 Kugwintsa ntchito fanulo potunga madzi mzigubu zakukamwa kochepa
Njira ya Chiwiri
 Kukonza njira zabwino zoti madzi adzilowa moyendera
Njira ya Chitatu
 Kulimapo Dimba pogwintsa ntchito madzi otakira
Njira ya Chinayi
 Kuchotsa zinyalala, kutsuka miyala ndi kukapa dzenje.
Njira ya Chisanu
 Kupatutsa njira yodutsa madzi ndi Cholinga chokapa darrije
NDEMANGA
 Zithunzi ndi uthenga zikugwirizana

<Card 5>

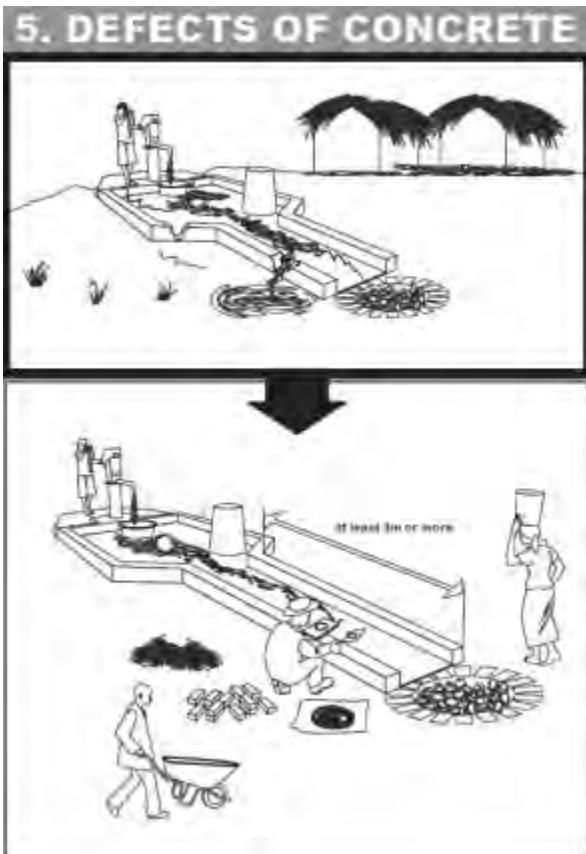

Material 5: Defects of concrete

ENGLISH:

1. **TITLE:** Defects of concrete
2. **PROBLEMATIC SITUATION:** Concrete drainage channel attached to apron is less than 3 meters long ending a soak away pit or vegetable garden.
3. **SOLUTION OR/AND DESIRABLE SITUATION**
 - **SOLUTION 1:** Improve natural drainage by lengthening it up to at least 3 meters or more or mobilize resources and extend drainage channel to at least 3 meters.

CHICHEWA:

Kuonongeka kwa konkileti pa Mjigo

BVUTO:

Ngalande inapwanyikapwanyika
 Ngalande ndi Yayifupi indipo madzi amatulukira pambali
 Madzi adekha pa mjigo

KUKONZA BVUTO

Timange ngalande yaitali, mamita osachepera atatu
 Tipeze njira yopezera zipangizo zoti tikonzere ngalande yaitali ndi malo onse
 owonongeka pa mjigo monga kukwilira mayenje onse

<Card 6>

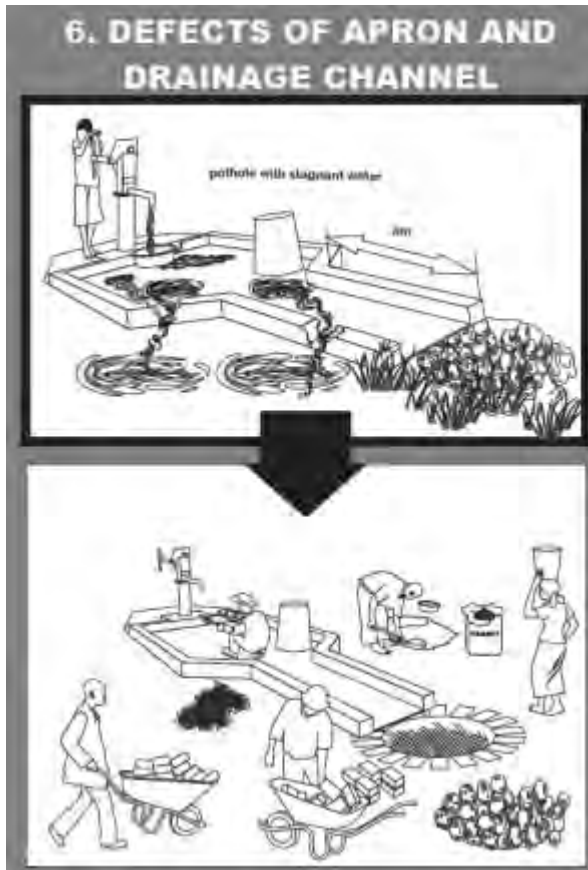

Material 6: Defects of apron and drainage channel

ENGLISH:

1. **TITLE:** Defects of apron and drainage channel
2. **PROBLEMATIC SITUATION:** Apron and 3 meters long drainage channel has cracks and pot holes with stagnant water.
3. **SOLUTION OR/AND DESIRABLE SITUATION**
 - **SOLUTION 1:** Mobilize resources and repair the drainage and the slope of the channel.

CHICHEWA:

KUSWEKA / KUWONONGEKA KWA APOLONI NDI NGALANDE YOYENDAMO MADZI

BVUTO

Kusweka kwa apoloni ndi ngalande yoyendamo madzi ndi mayenje modikha madzi

KUKONZA KUTHETSA BVUTO

Kupeza zipangizo zokonzera Apoloni ndi Ngalande yoyendamo madzi monga izi:- Simenti - Njerwa - Mchenga - Miyala - Willibala - Makasu - Madzi ndi anthu ogwira ntchito

NDEMANGA

Zithuzi ndi uthengawu zikugwirizana

<Card 7>

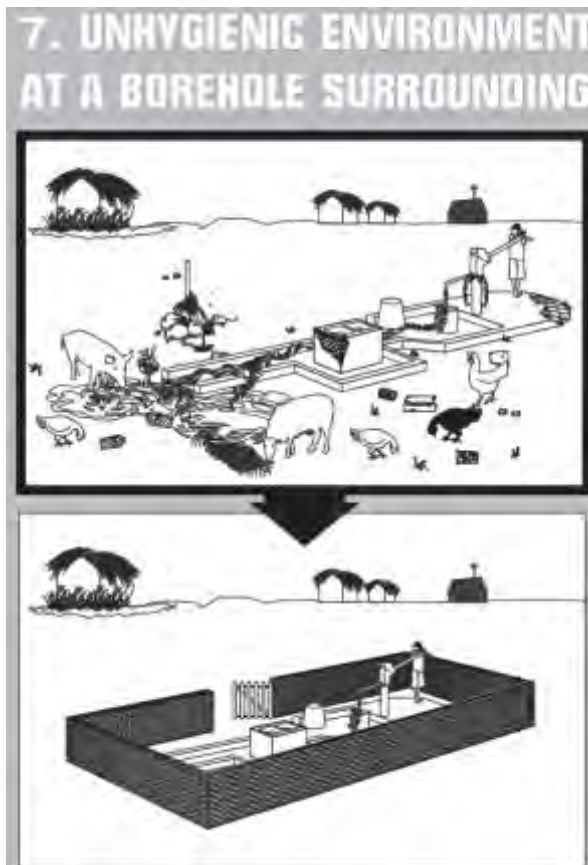

Material 7: Unhygienic environment at a borehole surrounding

ENGLISH:

1. **TITLE:** Unhygienic environment at a borehole surrounding
2. **PROBLEMATIC SITUATION:** General surrounding of a borehole is unhygienic (borehole untidy / dirty grown up grasses, shrubs/ vegetation).
3. **SOLUTION OR/AND DESIRABLE SITUATION**
 - **SOLUTION 1:** A tidy / clean borehole surrounding.

CHICHEWA

UMVE PA MALO OZUNGULIRA MJIGO ZOTSATIRA ZAKUSASAMALA PA MJIGO (MABVUTO)

Malo ozungulira pa mjigo amakhala osasesedwa, osalambulidwa komanso osatchchedwa

ZOYENERA KUCHITA / ZOYEMBEKEZERA

Malo a mjigo akhale osesedwa okolopedwa, olambulidwa, okhala ndi mpanda komanso dzenje logwelamo

Madzi.

CHITHUNZI CHOYAMBA

Palibe dzenje logweramo madzi

Palibe mpanda

Posasesedwa / kulambulidwa

Pali ziweto

Mjigo womasuka (ma bouti)

Mjigo wosazamalidwa

Session 2: Decision-Making for the Selection and Construction of Appropriate Water Point Sanitation Facilities

Introduction

WPC with the communities have a responsibility for water point sanitation including the construction of fence and soak away pit with their own funds. However, few WPC actually have sanitary facilities such as fences and soak away pits. One of the reasons is the lack of ownership of the community and also that it is unaffordable to low income communities.

This session was developed to show that a wide range of options from very low-cost fencing and drainage facilities made of locally available materials to expensive ones requiring concrete, bricks and other purchased materials. This enables each community to make informed choices of the most appropriate, technically feasible and affordable fencing and drainage options that are suitable for own community.

Learning Objectives

By the end of this topic, participants will be able to:

1. Describe the options for type of fences
2. Describe the options for type of drainage facilities

Tool Kit

Tool kit 11: Informed Choice Booklet for Water Point Sanitation (Afridev handpump version)

Content

Options for fence type

Activity 3.3

Step 1

Facilitator asks participants to name options for different types of fence that can be constructed with locally available materials

Step 2

Facilitator summarises the discussion and presents the common types of fence

Purpose of fence

It is important to erect a good fence around the water point.

This can be done immediately after the construction of the well is finished, and should give enough space to operate the hand pump.

The advantages of fencing are that it serves to define quite clearly, for the whole community, the area of the well and it keeps animals away from the wellhead. In some cases, it may be necessary to have a gateway to keep out smaller animals such as goats and baby pigs.

The fencing can be made of suitable local materials like wood, glass, bamboo or bricks. Problems of replacement and repair can be avoided altogether, by using a living hedge as fencing (nursery and/or plant fence). Whatever type of fencing is used, it is important that access by the users is guaranteed.

Functions of a fence

To keep animals away from water point areas for the prevention of contamination of water source by animal faeces and destruction of soak away pit by animals.

Selection of fence type

There are numerous fencing styles, materials and designs available today. The following points are helpful for choosing the fence.

1. The availability of money against the total budget for construction
2. Fence maintenance. How often will you need to repair the fence?
3. Your style and design preferences

Based on the easy provision of low cost materials in Malawi, five types of fence, as shown in Table 6, are recommended for selection by the community.

Table 6: Five types of fence

No.	Type
F1	Grass Type
F2	Timber Type
F3	Bamboo Type
F5	Brick Type
F6	Brick with Plaster Type

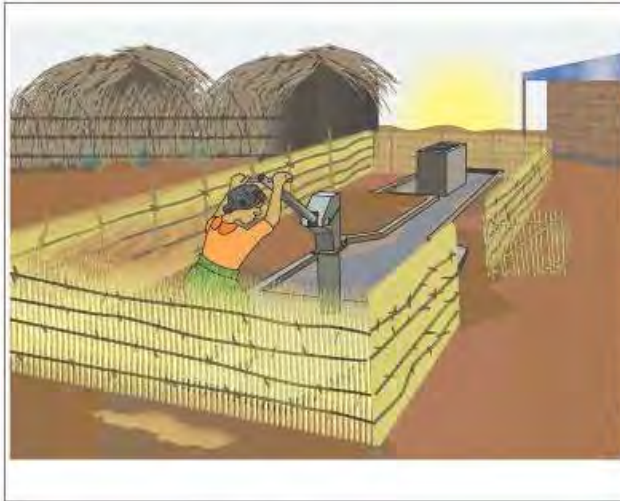

F1: Mpanda wa Tsekera	
Kupatikana mtango: 21,000 M3 (una mwazi wa September 2014)	
Ubwino	Kuyipa kwake
<ul style="list-style-type: none"> 100 peresenti zipangizo ziko zimepeleka Sumuwa Sumuwa kumaga Ndowosha mtango Zipangizo ziko zimepeleka kumada 	<ul style="list-style-type: none"> Sumuhalitan ndipono unakoma kukoma obela ndi obela Ndowosha Chawe chitha Anthu atha kuvasa
Zipangizo (Chisasa) G x B x H = 10m x 3m x 1.2m	
<ul style="list-style-type: none"> Tsekera: Mado 25 Khoje: Mipolota 90 Mitengo: Yekwana 10 Nzungwi: Zekwana 10 Uvira: Mipolota 100 	
Zida	
<ul style="list-style-type: none"> Chikwango: Chumoda Khasu: Linsoda Mpeni: Umochi 	

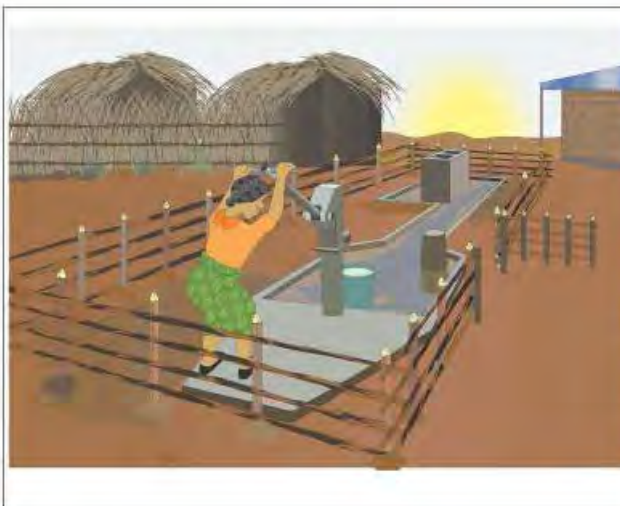

F2: Mpanda wa thabwa	
Kupatikana mtango: 36,000 M3 (una mwazi wa September 2014)	
Ubwino	Kuyipa kwake
<ul style="list-style-type: none"> 100 peresenti zipangizo ziko zimepeleka sakumada Sumuwa kumaga Ndowosha mtango Sumuwa kukomama Mutha kutha zimepeleka 	<ul style="list-style-type: none"> Umofuna kukoma chika ndi chika kuti ubiwoneka bwino Matalwa unathira kutocungika ngati soshuridwe molowala Chawe chitha kutocungika Anthu atha kuvasa
Zipangizo (Chisasa) G x B x H = 10m x 3m x 1.2m	
<ul style="list-style-type: none"> Matalwa: Yekwana 15 Misochi: 2 Kilo Matalwa athawo: 100 	
Zida	
<ul style="list-style-type: none"> Himala: Imochi Chikwango: Chumoda Khasu: Linsoda 	

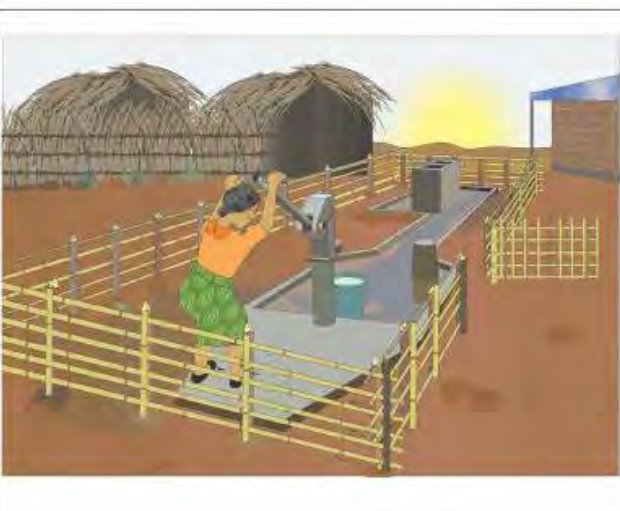

F3: Mpanda wa Nsungwi	
Kupatikana mtango: 15,000 M3 (una mwazi wa September 2014)	
Ubwino	Kuyipa kwake
<ul style="list-style-type: none"> 100 peresenti zipangizo ziko zimepeleka sakumada Sumuwa kumaga Zipangizo ziko zimepeleka kumada 	<ul style="list-style-type: none"> Umofuna kukoma chika ndi obela kuti ukhorekeka bwino Nzungwi zimechukumbira ngati soshuridwe molowala Chawe chitha kutocungika Anthu atha kuvasa
Zipangizo (Chisasa) G x B x H = 10m x 3m x 1.2m	
<ul style="list-style-type: none"> Nzungwi: Mado 42 Khoje: Mipolota 20 Uvira: Mipolota 15 Mitengo: Yekwana 10 	
Zida	
<ul style="list-style-type: none"> Chikwango: Chumoda Khasu: Linsoda Mpeni: Umochi 	

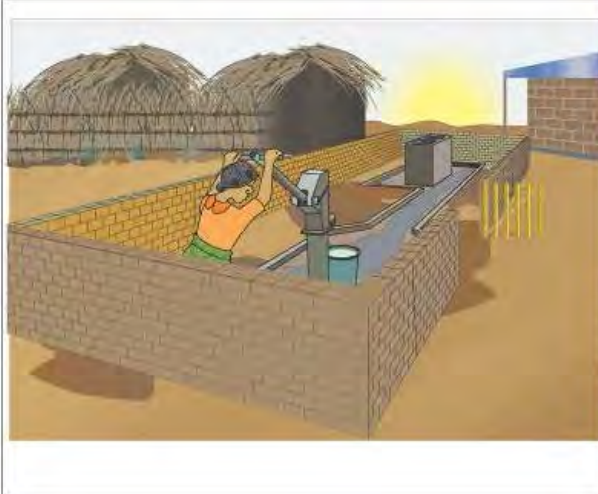

F5: Mpanda wa njerwa	
Kupakasa mungu: 75,000 MK (una mwazi wa September 2014)	
Uwazi	Kuipya kawala
<ul style="list-style-type: none"> Ndiwokozi Sumafana kuzakozwa 	<ul style="list-style-type: none"> Ndiwokozi mitengo kupata wazi wa matokeo ya mungu Uhu kugwa ngazi sumungu dawa bwazi kumana ngazi mabunga nchi sumu simunselimbu bwazi ulite kugwa
Zipangio (Chuo) (L x B x H = 1.5m x 3m x 1.2m)	
<ul style="list-style-type: none"> Nyawa: Zakwira 1050 Simeti: Mbagi 6 x 50kg Mbanga: Ngao sumu Matawa: Mpeti awi 	
Zida	
<ul style="list-style-type: none"> Mpeti omanga: 1 Umoti Lendo: 1 Inoti Wihaha: 1 Inoti Sherehi: 1 Inoti 	

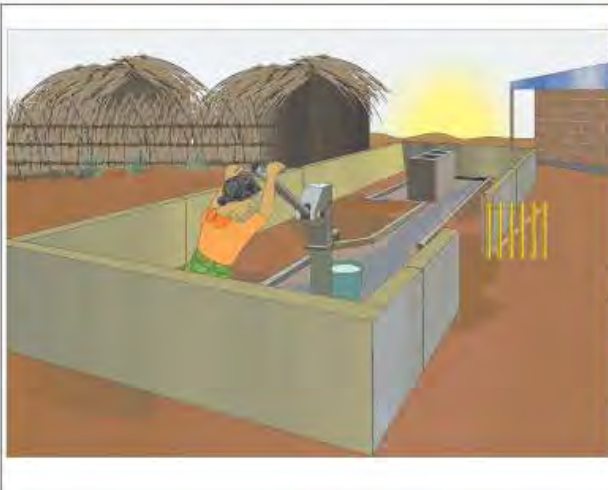

F6: Mpanda wa njerwa ndi pulasitani	
Kupakasa mungu: 50,000 MK (una mwazi wa September 2014)	
Uwazi	Kuipya kawala
<ul style="list-style-type: none"> Ndiwokozi Sumafana kuzakozwa 	<ul style="list-style-type: none"> Ndiwokozi mitengo kupata wazi wa matokeo ya mungu Uhu kugwa ngazi sumungu dawa bwazi kumana ngazi mabunga nchi sumu simunselimbu bwazi ulite kugwa
Zipangio (Chuo) (L x B x H = 1.5m x 3m x 1.2m)	
<ul style="list-style-type: none"> Nyawa: Zakwira 1050 Simeti: Mbagi 10 x 50kg (kuzakozwa) Mbanga: Ngao sumu Matawa: 2 peti 	
Zida	
<ul style="list-style-type: none"> Mpeti omanga: 1 Umoti Lendo: 1 Inoti Sivoti: 1 Inoti Wihaha: 1 Inoti 	

Options for type of drainage facilities

Activity 3.4

Step 1

Facilitator asks participants to brainstorm the options for types of drainage facilities

Step 2

Facilitator summarises the discussion and presents the common types of drainage facilities

Purpose of drainage facilities

A drainage channel can lead to a ditch or to an existing surface water drainage system, irrigation channel, cattle trough; and sometimes evapotranspiration beds (i.e. where the water is absorbed by plants).

If there are no drainage channels nearby, the water can soak into the ground in a way that will not place the groundwater source at risk. Typically, a soak away or a soak pit is used, or alternatively a French drain (a shallow stone-filled trench).

The safe distance between the disposal point and the borehole will mainly depend on the nature of the soil, the distance between the base of the soakage system and the groundwater table, and the length of borehole casing. The performance of all systems needs to be suitable for rainy as well as dry season conditions.

Functions of a soak away pit

There are mainly three functions of soak away pit.

- a. To prevent unsightly and unhygienic condition of the water point
- b. To prevent water contamination at the point of source
- c. To prevent producing mosquito breeding sites

Determination of size and design of soak away pit

(1) Size

The size of the soak away is determined mainly by the volume of liquid effluents produced and local soil conditions.

Box 2 : Soil Permeability

Gravel has a higher soil permeability than clay soil. If the soil permeability is high like gravel, a small-sized pit is sufficient. On the contrary, if the soil permeability is low like clay soil, the size of the pit is required to be bigger than with gravel soil. So soil type is one of the factors to determine the size of the pit.

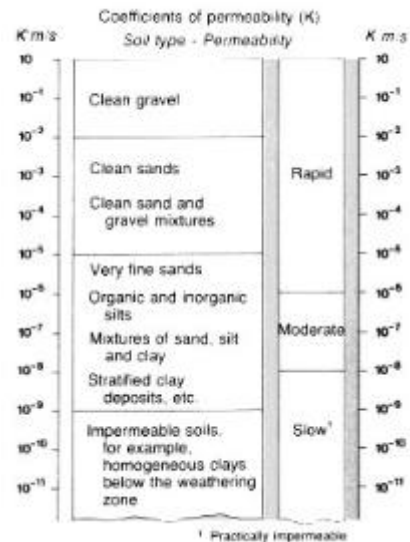

(2) Design of soak away pit

The pit may be filled with stones, broken bricks, etc., in which case no lining is needed, or may be lined with open-jointed masonry (often with a filing of sand or gravel between the lining and the soil to improve infiltration).

The top 0.5 m of the pit should be lined solidly, to provide firm support for the reinforced concrete cover. The cover is sometimes buried by 0.2-0.3 m of soil to keep insects out of the pit.

With large effluent flows, drainage trenches may be more economical than a soak away. Planting trees adjacent to, or over, a soak away can improve both transpiration and permeability

(3) Type of facilities for drainage purposes

As mentioned above, a soak away pit is required to be filled with stones, broken bricks, etc., however in consideration of limitation of procurement of materials and/or budget of the communities, six types of facilities for drainage purposes shown in Table 7 are recommended for selection by each community. **Type S3, S4 and S5 is most recommendable.**

Table 7: Six types of facility for drainage purposes

No.	Type
S1	Digging pit with cover
S2	Protected pit with cover
S3	Digging pit with crushed stone
S4	Protected pit with crushed stone
S5	Ground drainage channel
S6	Vegetable garden

S1: Dzenje lokumba koma Lovindikira

Kopelakana mabanga: 11,000 Mb (ma amava wa September 2014)

Ubwano	Kopiga kwako
<ul style="list-style-type: none"> Sika kusha mabanga Phimansira kutumba (kuzafika zofika kutumba) 	<ul style="list-style-type: none"> Lamankhala kuti kuzafika kuti kutumba Phimansira kutumba (kuzafika zofika kutumba) Mabanga kutumba kuti kutumba kuti kutumba

Zipangizo (Chitsanzo) (L x B x H = 1m x 1m x 1m)

Zida
<ul style="list-style-type: none"> Mabanga kutumba Phimansira kutumba Phimansira kutumba Phimansira kutumba

S2: Dzenje lokumba koma lowaka lili ndi chovindikira

Kopelakana mabanga: 11,000 Mb (ma amava wa September 2014)

Ubwano	Kopiga kwako
<ul style="list-style-type: none"> Zidankhala kutumba kuti kutumba 	<ul style="list-style-type: none"> Mabanga kutumba kuti kutumba kuti kutumba Mabanga kutumba kuti kutumba kuti kutumba

Zipangizo (Chitsanzo) (L x B x H = 1m x 1m x 1m)

Zida
<ul style="list-style-type: none"> Mabanga kutumba Phimansira kutumba Phimansira kutumba Phimansira kutumba

S3: Dzenje lokumba koma lili ndi miyala (Recommendable type)

Kopelakana mabanga: 11,000 Mb (ma amava wa September 2014)

Ubwano	Kopiga kwako
<ul style="list-style-type: none"> Mabanga kutumba kuti kutumba kuti kutumba Mabanga kutumba kuti kutumba kuti kutumba Mabanga kutumba kuti kutumba kuti kutumba 	<ul style="list-style-type: none"> Lamankhala kuti kutumba kuti kutumba

Zipangizo (Chitsanzo) (L x B x H = 1m x 1m x 1m)

Zida
<ul style="list-style-type: none"> Mabanga kutumba Phimansira kutumba Phimansira kutumba Phimansira kutumba

S4: Dzenje lokumba lowaka bwino lili ndi miyala (Recommendable type)

Kopelakana mabanga: 11,000 Mb (ma amava wa September 2014)

Ubwano	Kopiga kwako
<ul style="list-style-type: none"> Mabanga kutumba kuti kutumba kuti kutumba Mabanga kutumba kuti kutumba kuti kutumba Mabanga kutumba kuti kutumba kuti kutumba 	<ul style="list-style-type: none"> Lamankhala kuti kutumba kuti kutumba Mabanga kutumba kuti kutumba kuti kutumba

Zipangizo (Chitsanzo) (L x B x H = 1m x 1m x 1m)

Zida
<ul style="list-style-type: none"> Mabanga kutumba Phimansira kutumba Phimansira kutumba Phimansira kutumba

S5: Dzenje lowaka lokhala ndi chovindikira cha konkriti komanso ngalande zovindikira bwino (Recommendable type)

Kopelakana mabanga: 11,000 Mb (ma amava wa September 2014)

Ubwano	Kopiga kwako
<ul style="list-style-type: none"> Mabanga kutumba kuti kutumba kuti kutumba Mabanga kutumba kuti kutumba kuti kutumba Mabanga kutumba kuti kutumba kuti kutumba 	<ul style="list-style-type: none"> Lamankhala kuti kutumba kuti kutumba Mabanga kutumba kuti kutumba kuti kutumba

Zipangizo (Chitsanzo) (L x B x H = 1m x 1m x 1m)

Zida
<ul style="list-style-type: none"> Mabanga kutumba Phimansira kutumba Phimansira kutumba Phimansira kutumba

S6: Dimba

Kopelakana mabanga: 1,000 Mb (ma amava wa September 2014)

Ubwano	Kopiga kwako
<ul style="list-style-type: none"> Mabanga kutumba kuti kutumba kuti kutumba Mabanga kutumba kuti kutumba kuti kutumba Mabanga kutumba kuti kutumba kuti kutumba 	<ul style="list-style-type: none"> Lamankhala kuti kutumba kuti kutumba Mabanga kutumba kuti kutumba kuti kutumba

Zipangizo (Chitsanzo) (L x B x H = 1m x 1m x 1m)

Zida
<ul style="list-style-type: none"> Mabanga kutumba Phimansira kutumba Phimansira kutumba Phimansira kutumba

Session 3: Promotion Materials for Water Point Sanitation

Introduction

This topic will provide information on the use of two types of promotion materials; “Village Head’s Consensus Form for Water Point Sanitation” and “Promotion Song: We Should not Underrate” as tools to facilitate community involvement and participation.

Learning Objectives

By the end of this session, participants will be able to describe and understand how to use two promotion materials for water point sanitation

Tool Kit

Tool 12: Village Head’s Consensus Form for the Promotion of Water Point Sanitation

Tool 13: Promotion Song for Water Point Sanitation (We should not underrate)

Content

Village Head’s Consensus Form

Activity 3.5

Step 1

Provide the village head’s consensus form to the participants and discuss about the content of the form

Step 2

Ask participants the name of influential people in their village, i.e., village head, natural leaders, etc. and let them decide on who should be signing the consensus form

Step 3

Fill in all other information required in the Consensus Form

Step 4

Discuss who should keep the village head’s consensus form and on which occasions to display the forms. For example, the form could be displayed during village meetings, in a tree near the borehole, when the borehole surroundings need to be cleaned, when the soak away pit looks untidy, etc.

Purpose of the Village Head’s Consensus Form

The form was developed to obtain the commitment of the village head, influential person in the village and the chair of the WPC/VHWC to encourage collaboration of all villagers in improving water point sanitation and maintaining clean borehole surroundings.

Content and Detail of the Consensus Form

The Village Head’s Consensus Form contains the following information:

- Key message “Be a healthy model village, keep your water point and its surrounding clean, always”
- Village head’s endorsement
- Name of the village
- Identification of the water point
- Date, name and signature of the village head
- Date, name and signature of the influential person
- Date, name and signature of the chair of the WPC/VHWC
- Target audience: women, men and children

Khalani mudzi wachitsanzo ndi wathanzi

Samalirani mjigo ndi malo ozungulira, nthawi zonse



Ine, _____ wa m'mudzi
wa _____, ndikulonjeza kuti mudzi wathu
udzakhala wachitsanzo ndi wathanzi posamalira mjigo ndi malo ozungulira.

(Dzina la Mfumu) (Saini) (Tsiku)

Pa maso pa:

(Dzina la wapampando wa WPC) (Saini) (Tsiku)

ndi

(Dzina la mboni) (Saini) (Tsiku)

MJIGO: MUDZI:

Figure 5: Village Head’s Consensus Form for the promotion of Water Point Sanitation

Promotion Song for Water Point Sanitation “We should not underrate”

Activity 3.6

Step 1

Provide the script of the promotion song “We should not underrate” to the participants and discuss about the content of the song

Step 2

Play the song and practice at least twice

Step 3

Ask participants if there are musicians, bands, choirs in the village and whether they can prepare a song with the same type of message in their own traditional tune. Allow them to suggest key messages and practice their song

Step 4

Discuss about effective events and time to sing the promotion song so that the message is passed on to the whole community. Some villagers use the promotion song in village meetings, village bank meetings, when the borehole surroundings need to be cleaned, when the soak away pit looks untidy, when conducting development work such as moulding bricks and construction of sanitary facilities/structures, etc.



Figure 6: CD with promotion songs provided in the tool kit

SONG 2 TISAMANYOZERE		
VERSE 1		
Odi odi kumudziko ndabwera ndinkhani ndilandireni		Ndikupemphaninso mafumu mavolontiya ndi village band
Nkhani yanga ine siyapatali ndichisamaliro chapamjigo		Alimbikitseni anthu anu kusamalira mijigo yao
Madzi apamjigo ndiakuhondo ndipo amatuluka ali abwino zedi		Pamjigo pakakhala paukhondo mudzi onse umalemekezeka
Koma ngati sitisamalira pamjigo patha kulowa matenda		Anthu ochokera midzi yozungulira naonso amatenga chitsanzo
Mjigo wathu tiasamalire usayandikane ndi zonyasa zonse		
Usakhale pafupi ndichimbudzi komanso dzala likhale kutali		TRADITIONAL TUNE
Timange kampanda kuzungulira pamjigo pathu		
Tisaiwalenso kukumba dzenje motaikira madziapamjigo		Lead Sitinalore kukhala chitsanzo chaumve
Dzenje lake lalitali bwino komanso tiikemo miyala		Back Sitalore kukhala chitsanzo chaumve
Pazikhal posesa bwino nthawi zonse tisalore umve		Lead Takonzeka kukhala chitsanzo chaukhondo
		Back Takonzeka kukhala chitsanzo chaukhondo
		Lead Takonzeka kukhala mudzi wa chitsanzo ife
		Back Takonzeka kukhala mudzi wa chitsanzo ife
		Lead Pantchito yosamala pamjigo pathu ife
		Back Pantchito yosamala pamjigo pathu ife
		Lead Akabwera alendo azisilira ife
		Back Akabwera alendo azisilira ife
		Lead Amfumu athu ali patsogolo
		Back Amfumu athu ali patsogolo
		Lead Azimayi ndi abambo tili pambuyopo
		Back Azimayi ndi abambo tili pambuyopo
		CHORUS
Lead	Nkanakonda muli mudzi wachitsanzo	Lead Nkanakonda muli mudzi wachitsanzo
All	Tisamanyozere	All Tisamanyozere
Lead	Panchito yosamalira pamjigo	Lead Panchito yosamalira pamjigo
All	Tisamanyozere	All Tisamanyozere
Lead	Akabwera alendo azisilira	Lead Akabwera alendo azisilira
All	Tisamanyozere	All Tisamanyozere
Lead	Azikopeka ndikukapanganso choncho	Lead Azikopeka ndikukapanganso choncho
All	Tisamanyozere	All Tisamanyozere
VERSE 2		
Akulu amati wakutsina khutu ndiye mnasi wako		
Amanenanso momveka bwino ukundisokosa nkulinga utamva iwe		
Ndiudindo wanu azimayi kutenga mbali pantchitoyi		
Poti ntchito yonse yaikhondo wapakhomo iimira inu		
Ndimvereninsu azibambomusakhale chete chilimikani		
Poti nchito yosamala mjigo popanda inu ndithu siingatheke		

Figure 7: Script of the Promotion Song “We should not underrate”

Purpose of the Promotion Song “We should not underrate”

The promotion song was developed to be used to pass on key messages to the villagers on the importance of protecting the water source from contamination and maintaining a clean borehole surrounding. It was designed to be:

- Attractive: so that it pulls people in
- Uses local language: so that people feel it concerns them
- Repetitive: so that messages are retained
- Easy to understand: so nobody gets confused
- Participatory: so exchange of views is most effective
- Provocative: so that they are memorable and discussed

Details of the Promotion Song “We should not underrate”

- Singer: Skeffa Chimoto
- Target Audience: Men, women and children
- Key message “Be a healthy model village, keep your water point and its surrounding clean, always”
- Specific features: includes whistling to promote water point sanitation. The whistling alone or the song could be used when WPC/VHWC members and/or beneficiaries are cleaning the borehole surrounding, regular cleaning of the soak away pit, construction of sanitary facilities such as fence, soak away pit, etc.

Session 4: Sanitation and Hygiene

Introduction

Most communities are concerned about improving their water supply facilities. Access to safe water is very important but lack of good sanitation facilities such as latrines and hand washing facilities and poor hygiene practices are also a great risk to health. All water projects approved by the District Council will include sanitation and hygiene. Therefore, when improving water supply facilities, it is also important to include improvements in sanitation and hygiene.

The water users of a village should receive hygiene training with regard to the collection, storage and use of water. For example, the transmission of disease through contaminated water may not be understood by the community.

Learning Objectives

By the end of this session, participants will be able to:

1. Understand the general principles of sanitation and hygiene
2. Propose development activities that can be included to promote sanitation and hygiene

Content

Sanitation and Hygiene

Activity 3.7

Step 1

Facilitator asks the following questions to be discussed by the participants. Participants should involve men and women. Special effort should be made to involve women.

Water:

- Is our pump in good condition? Or is it often broken down?
- Who repairs it? Are repairs delayed? If so, why?
- Is the area around the hand pump clean and in good condition?
- Is there enough water for all of us? All year round?
- Who is responsible for cleaning the borehole surrounding? Is there a cleaning or duty roster in place?

Sanitation:

- How many households have improved latrines?
- Do people use the latrines? If not, why?
- What do people in our community think about latrines?
- What are the roles of women and men on sanitation?
- What is the biggest problem about latrines, if any (i.e., cultural issues, soil conditions, lack of materials for construction, etc)?
- How do we dispose solid waste?

Hygiene:

- What are the most common hygiene practices in our village (i.e., hand washing, covering pots, cleaning around the house, etc)
- What hygiene practices need to be improved?

- What hygiene education has already been provided in our village?
- How has this hygiene education changed the way we do things?

Step 2

Facilitator summarizes discussions and gets agreement on the most important needs. These discussions will look at the current situation – water and sanitation related diseases and how the use of sufficient quantities of water and safe use of latrines can reduce these diseases; then look at practical ways to improve hygiene and sanitation and plan for these changes.

Sanitation and hygienic practices which promote good health are summarised in the table below

Sanitation and Hygiene Practices	Importance
Hand washing with soap	<ul style="list-style-type: none"> • Prevents transmission of diarrhoeal diseases e.g. cholera, typhoid, dysentery • Promotes personal hygiene • Promotes social interaction
Drinking safe water	<ul style="list-style-type: none"> • Prevents diarrhoeal diseases e.g. cholera, dysentery, typhoid • Prevents polio
Covering of pit latrine drop hole	<ul style="list-style-type: none"> • Prevents breeding of disease vectors and vermin e.g. flies, cockroaches and rats - therefore prevents transmission of diarrhoea and other parasitic diseases • Reduces smell from coming out of the hole
Proper disposal of waste water	<ul style="list-style-type: none"> • Prevents breeding of mosquitoes that cause malaria • Facilitates cleanliness of the surroundings
Proper disposal of solid waste	<ul style="list-style-type: none"> • Prevents eye infections by reducing the breeding of flies; and rat infestations • Facilitates clean surroundings
Bathing/ washing with safe water / Washing clothes with safe water	<ul style="list-style-type: none"> • Prevents skin infections e.g. scabies, leprosy • Prevents infection from bilharzia • Promotes personal cleanliness • Prevents eye infections • Prevents infestations of lice
Using improved pit latrines	<ul style="list-style-type: none"> • Prevents diseases e.g. cholera, typhoid, dysentery, infection from bilharzia, polio • Provides privacy, social status and comfort to the users • Controls the breeding of flies
Using bath shelters	<ul style="list-style-type: none"> • Prevents infection from bilharzias • Promotes personal hygiene • Offers privacy

Diarrhoeal diseases and mode of transmission

Diarrhoea is generally caused by eating food and drinking water that is contaminated with human faeces. Infants may suffer from diarrhoea after being hand-fed by someone with dirty hands, or after having put dirty objects into their mouths. The diagram below shows the usual way diarrhoeal germs reach people: via fingers, flies (insects), fields and fluids, food, or directly into the mouth. Because of the use of so many “F” words in English, it is often called the “F-diagram”.

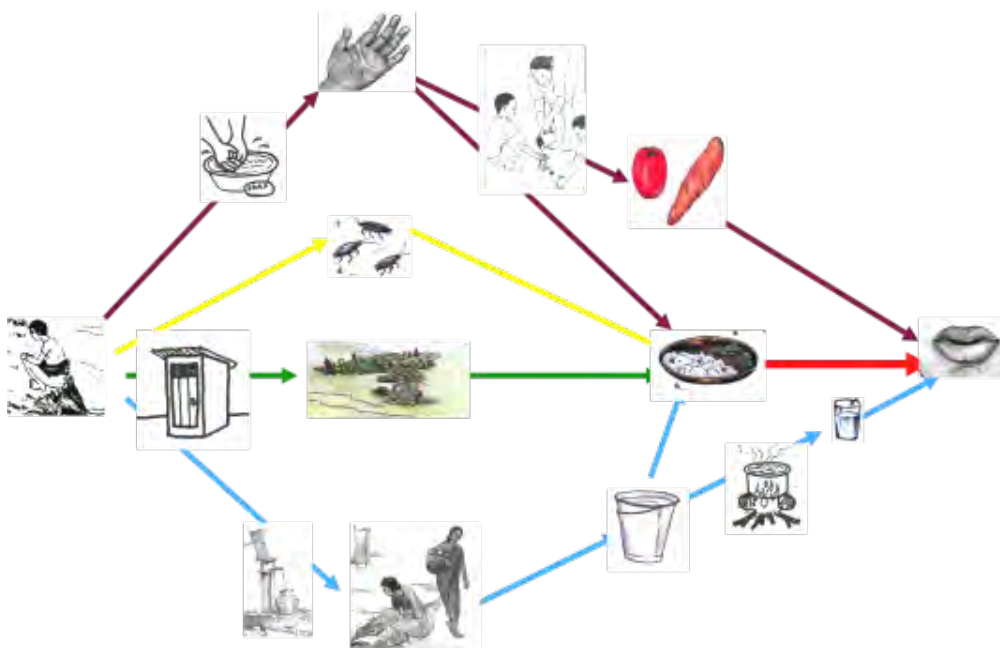

Figure 8: Transmission Routes

References

Ministry of Irrigation and Water Development (2010), Participatory Sanitation and Hygiene Promotion Implementation Manual

Ministry of Water Development, Rural Water Supply and Sanitation program, Manual on Community Managed Boreholes

Module 4: Technical Components

Introduction

Technical components for operation and maintenance is important for ensuring that the water point is able to serve the communities adequately and continuously for at least 15 to 20 years.

Members of the VHWP/WPC should understand the technicalities of how to operate and maintain the water point properly.

Objectives

By the end of this module participants should be able to:

1. Identify fast and slow wearing parts of Afridev pump
2. Demonstrate proper use of the pump
3. Demonstrate an understanding of the major troubleshooting issues

Contents

This module contains the following topics:

- Session 1: Components of the water supply facility
- Session 2: Afridev handpump parts and functions
- Session 3: Pumping mechanism
- Session 4: O&M schedule
- Session 5: Trouble shooting
- Session 6: Afridev pump security system

Session 1: Components of the Water Supply Facility

Introduction

This topic aims at equipping participants with knowledge on components of the water supply facility.

Learning Objectives

By the end of this topic, participants will be able to explain functions of each component of the water supply facility

Content

Functions of each component of water supply facility

Activity 4.1

Step 1

In a lecture the facilitator describes the components of water supply facilities

Item	Functions
Boreholes	Boreholes are generally appropriate considering that groundwater is readily available in most places. Boreholes give access to ground water in an aquifer and facilitate abstraction of water from depths of a few meters to over 200 m. The maximum depth is determined by the type of pump or technology used. Generally the diameter range of the casing is between 0.1 m and 0.25 m.
Concrete apron	At ground level, a concrete apron is constructed around the borehole with an outlet adapted to the water abstraction method. This prevents surface water from seeping down the sides of the well, provides a hard stand and directs spilt water away from the well to a drainage channel.
Hand pump	The hand pump is usually fitted to the well after completion of the well construction. The type of pump to be fitted depends on several factors; (usage, ease of maintenance, cost, availability of spare parts, etc.). Many types and sizes of pumps are available for use in borehole water supply systems. The most commonly used pump for community supply in Malawi is Afridev while institutions such as health centres use Climax or Motorised pumps.
Drain	To guide spilt water further away from the well, usually towards a soak away filled with large stones where the water can infiltrate back into the ground, or evaporate from the stone surfaces at a safe distance from the well.
Fence	To prevent animals from entering and polluting the well and its surroundings.

Source: Implementation Manual For Piped and Point Water Supply Systems, July 2010 MoIWD

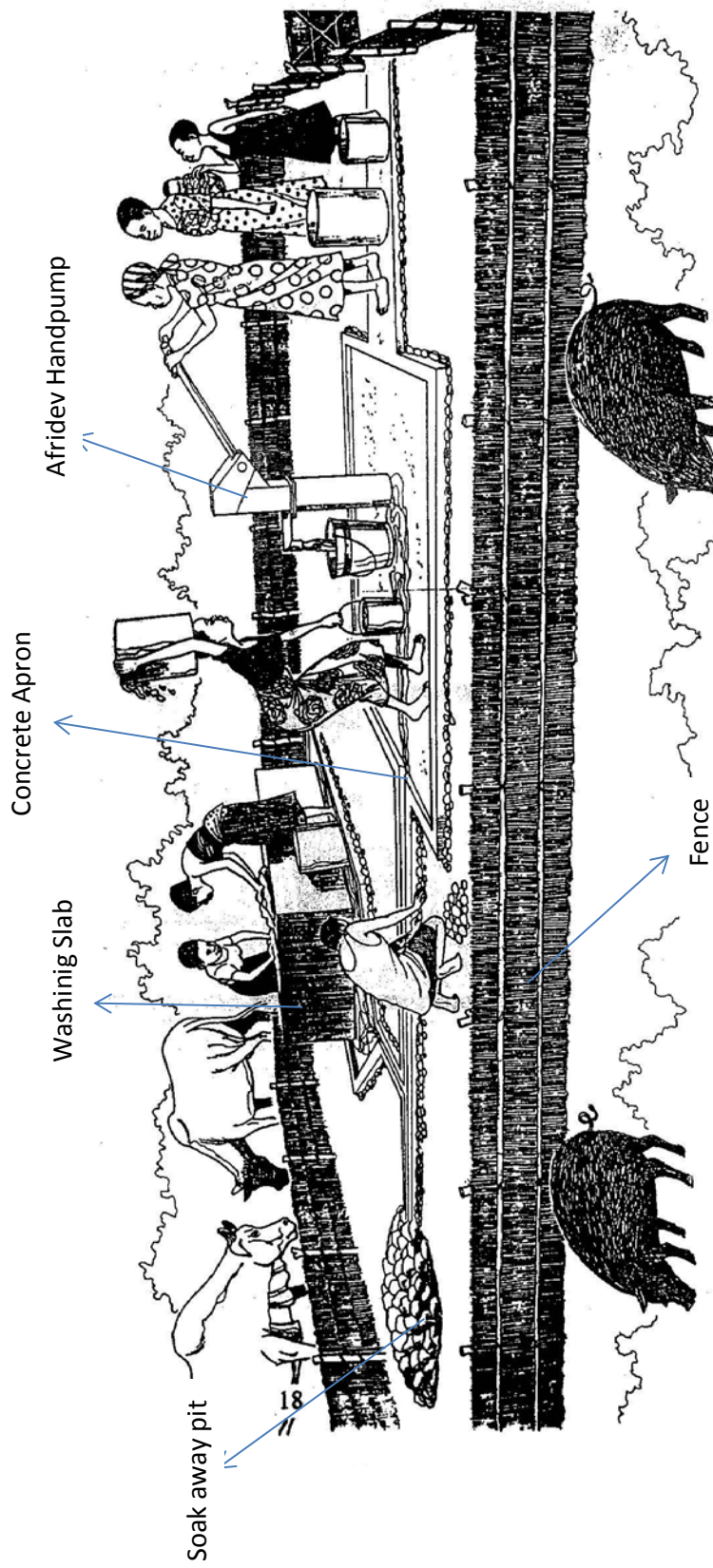

Session 2: Afridev Handpump Parts, Functions and Life Period

Introduction

This topic aims at equipping participants with knowledge of Afridev handpump parts and functions.

Learning Objectives

By the end of this topic, participants will be able to:

1. Understand how to assemble of the Afridev handpump
2. Familiarize themselves with the name of spare parts and its functions in the Afridev handpump
3. Identify the fast wearing spare parts
4. Familiarize themselves with the tools for dismantling and reassembling
5. Understand the life period of each spare part

Content

Afridev handpump parts and functions

Activity 4.2

Step 1

Facilitator asks the participants what spare parts they know.

Step 2

Facilitator shows the actual spare parts and lectures the names of the Afridev handpump spare parts and their functions.

Step 3





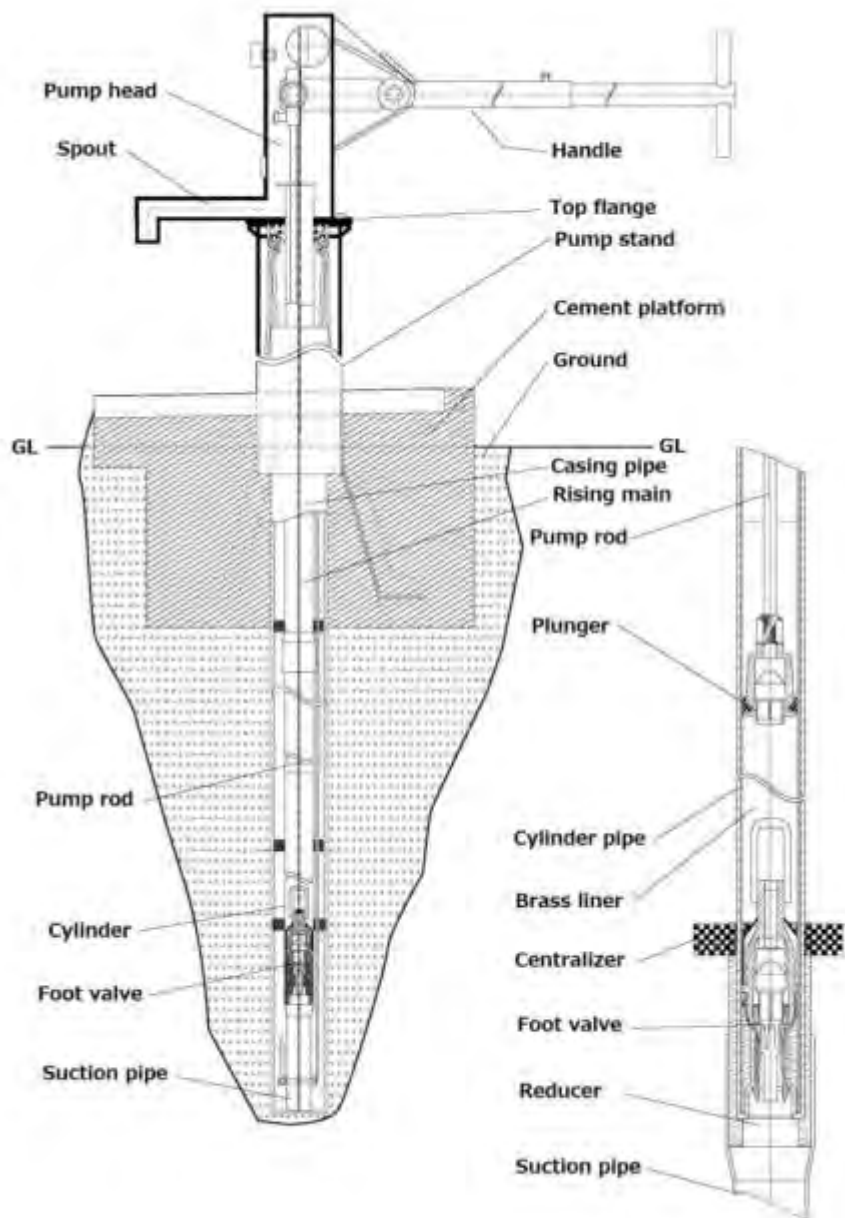



Facilitator circulates some spare parts, at least including fast wearing spare parts

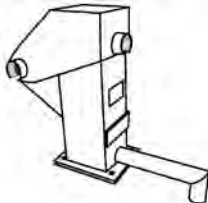

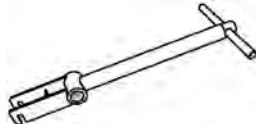
Assembly of the Afridev handpump

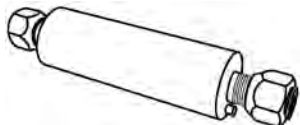
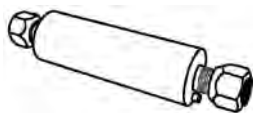





Source: Installation and Maintenance Manual for the Afridev Hand pump Revision 2- 2007, SKAT-RWSN





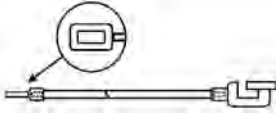
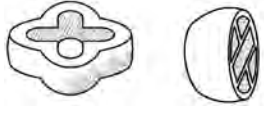
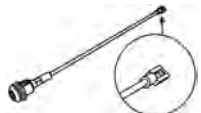

Afridev handpump parts and functions**a) Above ground components**

No.	Component	Function	Illustration
	English / Chichewa		
1	Head pump and cover / Hedipampu chi vindikilo	Encloses the topmost part of the pump to prevent dust and foreign materials from getting inside the pump, it houses the hanger assembly and supports the handle bar	
2	Pump pedestal / Pampupedesitilo	Main body supporting above ground components and below ground components	
3	T/bar / handulo	This is the part that is held to pump water. It can be adjusted to correspond to the depth of the BH	
4	Hanger Assembly / Hang'aAsembule	Rods are suspended from this	
5	Fulcrum pin / Fakulamupini	Joins the handle bar to the head pump and acts as a movement joint for the handle pumping water	
6	Hanger pin / Hang'apini	Joins the end part of the handle to the hanger to allow for upward and downward movement of the rods	
7	Bush bearing / BushiBelingi	Allows free movement of the fulcrum pin and hanger pin. There are four in a pump, two on the fulcrum pin and two on the hanger pin	
8	Rubber flapper / LabalaFulapa	Installed on the top rod to prevent foreign materials from getting into the rising main and to prevent water from gushing out	
9	Rubber Cone / Labalakoni	Sits between the pump head and pedestal acts as a seal to stop water from spilling between the pump head and pedestal	

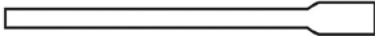
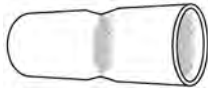
No.	Component	Function	Illustration
	English / Chichewa		
10	Steel cone plate / KoniPuleti	A metal plate holding the rising main	
11	Top sleeve(collar) / Topusilivi	It prevents the rising main from slipping through the rubber cone	

b) Below ground components

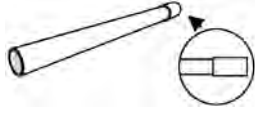

No.	Component	Function	Illustration
	English / Chichewa		
12	Pump rod / Pampurodi	To connect plunger so that the pump can be operated above the ground using the handle	
13	Rod Centralizer / RodiSentelelaiza	Fitted on rod joints to centralize rods and prevent friction between the rod and the rising main	
14	Plunger / Pulanja	Connected to pump rods; moves up and down with the movement of the handle to facilitate suction of and delivery of water	
15	Foot-Valve / FutuValavu	Keeps the pumped water from going back down the bore hole	
16	U-Seal / U-Silo	Fitted to the plunger body; seals water above plunger and pushes water up with every upward movement of the plunger (plastic plunger only)	
17	Cup-seal / Kapu-Silo	Fitted to the plunger body; seals water above plunger and pushes water up with every upward movement of the plunger (brass plunger only)	
18	O-ring / O-ring'i	Fitted to the foot valve to prevent water inside the cylinder from getting back into the bore hole	

No.	Component	Function	Illustration
	English / Chichewa		
19	Bobbin / Bobini	Fitted inside plunger and foot valve; moves up and down to allow water to move in one direction only and prevents water from getting back into the bore hole	
20	Rising main / Mapaipi	A pipe connected to cylinder assembly carries water from the cylinder to ground level	
21	Double end socket / Dabulosoketi	To join two rising mains after repairing (use solvent cement)	
22	Solvent cement / Soventisementi	To join two rising mains after repairing (use solvent cement)	
23	Rising main centraliser / Sentelelaiza wa ma paipi	Fitted every 3 meters, rising main prevents excessive swaying of the rising main in the borehole	
24	Cylinder assembly / SilindaAsembule	Most important part of the pump, it draws water from the borehole and pumps it up to ground level	
25	Suction pipe / Sakishonipaipi	Fitted at the bottom end of the cylinder it draws water into the cylinder and controls sand intake	
26	Rope(nylon rope 6mm) / Chingwe	Connected to the suction pipe and passes through the pipe centralizer to the cone plate to hold the rising main from falling into the borehole in case of joint failure	

Fast wearing spare parts

		
Bush bearing	U-seal	Bobbin
		
O-ring	Cup seal	Rod centralizer

Tools for dismantling and reassembling

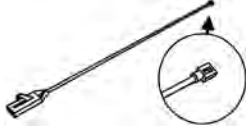
No.	Component	Function	Illustration
	English / Chichewa		
1	Socket spanner 24 / Spanarayabowo	To remove head cover and to hold the hanger assembly when removing rods	
2	Flat spanner 17/19 / Spanarayafulati	To remove the bolts between head and pedestal	
3	Fishing tool / Mbedza	To fish the foot valve and pump rods	

















Life period of each spare part

1) Body of Afridev handpump

Based on the conditions of the existing handpumps in Mchinji, the life time span of Afridev handpump is estimated to be around 15 years.

2) Each spare part of Afridev handpump

Based on the “Installation and Maintenance Manual for the Afridev Hand pump Revision 2- 2007, SKAT-RWSN”, replacement interval for each spare part is recommended as shown in the below table.

Parts name		Illustration	Replacement interval		Parts name		Illustration	Replacement interval	
			Approximate Lifetime	Recommended Replacement Interval				Approximate Lifetime	Recommended Replacement Interval
Pump head with Pump handle	Fulcrum pin assembly		5 to 8 years	replace as required	Rising main	Riser pipe		3 to 5 years	replace as required
	Hanger pin assembly		5 to 8 years	replace as required		Top sleeve		3 to 5 years	replace as required
	Rod hanger assembly		5 to 8 years	replace as required		Flapper		3 to 5 years	replace as required
	Bearing bush outer		1 to 2 years	every year		Centraliser 4"		3 to 5 years	replace as required
Pump rods	Pump rod assembly		3 to 5 years	replace as required	Pump Cylinder	Cylinder assemble		5 to 8 years	replace as required
	Centraliser		2 to 3 years	every second year		Plunger and Footvalve	Valve body assembly		3 to 5 years
Plunger and Footvalve	O-ring		2 to 3 years	every second year	Plunger and Footvalve	O-ring		2 to 3 years	every second year
	Bobbin		2 to 3 years	every second year		U-seal		1 to 2 years	every year

Session 3: Pumping Mechanism

Introduction

This topic aims at equipping participants with knowledge of pumping mechanism.

Learning Objectives

By the end of this topic, participants will be able to understand pumping mechanism.

Content

Pumping mechanism

Activity 4.3

Step 1

Facilitator asks the participants how the water is pumped from the ground.

Step 2

Facilitator demonstrates the pumping mechanism.

Step 3

Committee members, in consideration of gender balance, try to exercise the pumping demonstrations.

Preparation tools for demonstration

- Bucket
- Water
- Cylinder and foot valve with O-ring and bobbin
- Plastic plunger with U-seal and bobbin or brass plunger with cup-seal and bobbin
- Plunger rod



Demonstration

<p>Plunger rod is inserted in a cylinder pipe.</p>	<p>The inserted rod is moved up and down in the cylinder pipe.</p>

Box 3: Pumping mechanism

The mechanisms that make this possible are the two one-way valves (piston valve and foot valve), the piston seals (which seal off upper cylinder from lower cylinder), and the pump rod which connects everything to the pump handle above the ground.

Step 1: Up-Stroke

1. As you might expect, the piston assembly moves upward during the up-stroke.
2. During the upstroke the piston valve is closed.
3. Water that is in the upper cylinder is under positive pressure and is pushed upward into the riser main.
4. Negative pressure is created in the lower cylinder. This negative pressure causes the foot valve to open and water is pulled into and fills the lower cylinder.

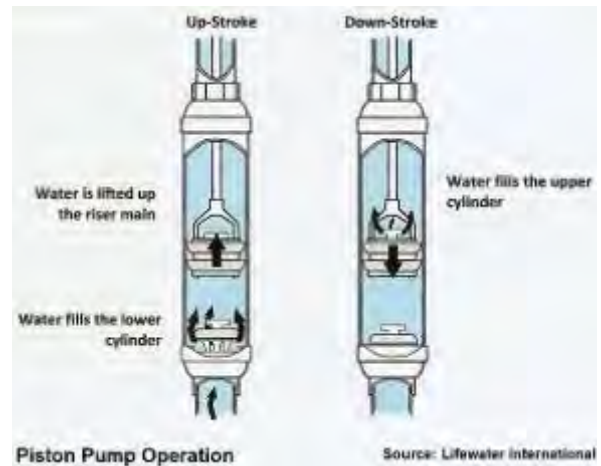
**Step 2: Down-Stroke**

1. As the piston assembly moves downward, pressure increases in the lower cylinder and the foot valve closes.
2. Increasing pressure in the lower cylinder also pushes the piston valve open and water flows upward and fills the upper cylinder.
3. As the up-stroke is repeated, water is again pushed upward through the riser main.
4. This process is repeated over and over again as the pump handle is operated.
5. Water moves from lower cylinder to upper cylinder and up the riser main.

Source: <http://www.clean-water-for-laymen.com/hand-water-pumps.html>

Session 4: O&M Schedule

Introduction

This topic aims at equipping participants with knowledge of O&M schedule.

Learning Objectives

By the end of this topic, participants will be able to:

1. Understand importance of maintenance
2. Understand type of maintenance
3. Understand O&M schedule.
4. Replace the fast wearing spare parts.

Tool kit

Tool 14: O&M Schedule

Content

Importance of maintenance

Activity 4.4

Step 1

Facilitator asks the participants to brainstorm why maintenance is important?

Step 2

Facilitator consolidates and summarises the responses.

Importance of maintenance

If no maintenance is conducted on the facilities:

- Frequent breakdown occurs thus the quality of services tends to decrease over time
- In some cases leading to complete failure
- The facility is unable to be used for its entire life span
- The resulting need for a new water facility to replace the original service will normally be more expensive overall

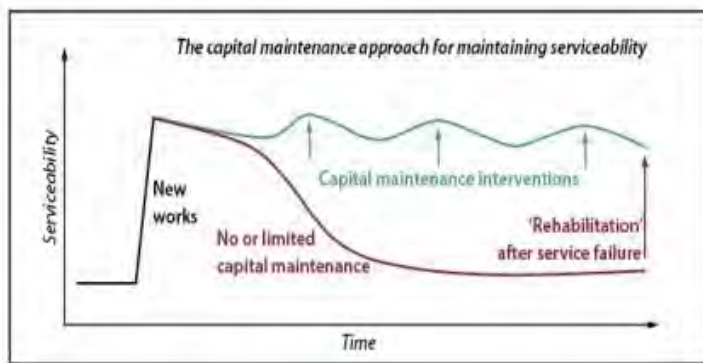

The blue line shows that regular capital maintenance maintains serviceability, while (red line) service levels fall away over time without capital maintenance, eventually requiring the service to be "rehabilitated" or replaced.

Source: WASH cost Briefing Note 1b, August 2010, website at: www.washcost.info/pubs

Figure 9: Capital maintenance and serviceability

Significance of prevention

To keep our bodies in good health it is ideal to do moderate exercise and undergo periodic medical examinations, and if we feel anything is wrong with our body, we seek prompt medical treatment.

Water supply facilities need the same kind of care and attention as our bodies. Although newly constructed boreholes work fine, they slowly deteriorate due to wind, rain, moisture, warm temperature, and measures are necessary to prevent deterioration.

In order to keep the good condition of the facilities, it is necessary to maintain the facilities by periodically checking the deterioration and damage.

In order to maintain stable and safe operation, proper maintenance, periodic overhaul, replacement & repair of parts and daily checking of operating condition are very important in the same way as a human being receives regular medical examinations and treatment.



Purpose of prevention

- To ensure the safety and security
- To ensure the convenience
- Reduction of life cycle costs (LCC)

Type of maintenance

Activity 4.5

Step 1

Facilitator asks the participants how the pump should be properly maintained.

Step 2

Facilitator consolidates the discussions and presents the common type of maintenance.

Type of maintenance

1) Preventive maintenance

Preventive maintenance is a pre-scheduled systematic inspection that involves repair(s) and/or replacement of parts in the system (WUA Training Manual, 2010).

Advantages of preventive Maintenance

- Since the parts and consumable parts of the facility can be replaced at a decided interval, proper treatment can be promptly given, and operation or suspension of use of the facility can be done systematically.
- It is possible to detect signs of abnormalities early and to deal with the problems before trouble occurs by monitoring the operating status and performing degradation checks.
- When a facility is maintained regularly, performance and lifetime of the facility can be expected to extend.
- Since the maintenance budget will be secured systematically, it is easy to make the O&M plan, and also it will be systematically implemented.

2) Breakdown maintenance

It is a timely response to breakdowns and public complaints and it involves carrying out repairs or replacement of parts in the system (WUA Training Manual, 2010).

Issues of the breakdown maintenance

- Simple and minor repairs can consequentially become major repairs, and unexpected failures can mean the facility is no longer able to be used because the facility has not been maintained properly until there is a marked impact on the function of facility. It would be a minor problem if the trouble had been dealt with immediately through periodic maintenance.
- It consequentially increases repair costs because it necessitates major repairs.
- Since the maintenance budget will not be secured systematically, repairs and delays and extra costs are required.

3) Facility maintenance and reliability

Level	Level 1	Level 2	Level 3
	Prolonged trouble	Minimized trouble	Avoided trouble
Reliability of facility service			
Contents	Evaluating measures after the trouble occurs	Even if trouble occurs, the effect will be limited, and the functions will be recovered quickly.	To maintain good conditions by predicting the trouble in advance and taking measures



Level		Level 1	Level 2	Level 3
		Prolonged trouble	Minimized trouble	Avoided trouble
Maintenance management required by the WPC	Tariff collection	After the trouble occurs, O&M fund is collected.	Tariff collection is conducted regularly.	Tariff collection is regularly conducted.
	Saving deposit / Stock of the parts	<ul style="list-style-type: none"> - Spare parts are not stocked. - O&M funds are not saved. 	<ul style="list-style-type: none"> - Spare parts are stocked. - O&M funds are saved. 	<ul style="list-style-type: none"> - Spare parts are stocked. - O&M fund are saved.
	Periodic maintenance	<ul style="list-style-type: none"> - Nothing is usually done. - Deal with a problem after the trouble occurs. 	<ul style="list-style-type: none"> - WPC conducts regular maintenance such as diagnosis and replacement of the parts by themselves. 	<ul style="list-style-type: none"> - WPC conducts regular maintenance such as diagnosis and replacement of the parts by themselves. - WPC concludes preventive maintenance contract with AM and regular maintenance is conducted.
Type of maintenance		<div style="display: flex; justify-content: space-around; align-items: center;"> <div style="border: 1px solid black; border-radius: 10px; padding: 5px; background-color: #e6f2ff;">Breakdown Maintenance</div> <div style="border: 1px solid black; border-radius: 10px; padding: 5px; background-color: #4a86e8; color: white;">Preventive Maintenance</div> </div>		

General problems on Afridev handpump

1) Rod

		
Rusty steel rod	Damaged hook of steel rod	Bended hook of steel rod

2) Plunger and foot valve

		
Plunger missing a U-seal and O-ring installed by mistake	U-seal installed in foot valve by mistake	Brass plunger missing a cup-seal

Note:

The community tend to misunderstand the combination of each spare part for plunger and foot valve. Therefore it is important for the communities to understand this point by repetition during the training.

Component	Combination of the parts
Plastic plunger	U-seal + Bobbin
Brass plunger	Cup-seal + Bobbin
Foot valve	O-ring + Bobbin

3) Worn out consumable parts

		
Worn out u-seal on plunger	Worn out rod-centraliser	Worn out flapper

4) Handle

	
Damaged handle	

5) Hanger pin and fulcrum pin

		
Damaged hanger pin due to rust	Rusty bolt and male screw (external thread) on fulcrum pin	Damaged hanger pin

6) Rising main (pipe)

		
Cracked pipe	Pipe connection by burned socket	

Box 4: Results of the diagnosis of Afridev handpumps in Mchinji

The latest survey on the 300 boreholes constructed by a Japanese grant aid project from 1992 to 1995 found that the ratio of currently working boreholes is 70%. No clogging of the screen due to siltation or the depletion of groundwater was observed and the main cause of nonoperation was malfunctioning of the hand pump system, including the riser pipe.

(1) Causes of hand pump breakdown

There are two principal causes of hand pump breakdown as described below.

- a. Abrasion or damage to the mild steel pump rod, etc. (natural deterioration of the product)
- b. Abrasion or damage to expendables such as the u-seal, bobbin or rod centraliser

The abrasion or damage observed with the mild steel pump rod and others is attributable to corrosion during more than 15 years of operation, suggesting that these parts have practically reached the end of their service life. Meanwhile, the cracks and linear scars observed with the PVC riser pipe are believed to be caused by the repeated contact of a broken or bent pump rod with the inner wall of the pipe.

The below table is a histogram showing the parts responsible for the non-functionality of a borehole as discovered by lifting the rod and pipe of a broken down hand pump. Apart from the pump rod already mentioned, the u-seal appears to be the most frequent cause of borehole breakdown, followed by the rod centraliser and the O-ring.

These findings suggest that expendables which **require regular replacement were not properly replaced.**

Another frequent cause is the deformation or damage to plastic parts such as the plunger and foot valve. Such deformation or damage leads to the breakdown of borehole operation or a decline of the pumping yield due to leakage. While these parts also require replacement based on regular checks, it is important to improve the durability of parts to reduce the frequency of borehole breakdowns.

Source: Preparatory Survey Report on the Project for Selected Market Centres and Rural Water Supply in Mchinji and Kasungu District in the Republic of Malawi, February 2012, JICA

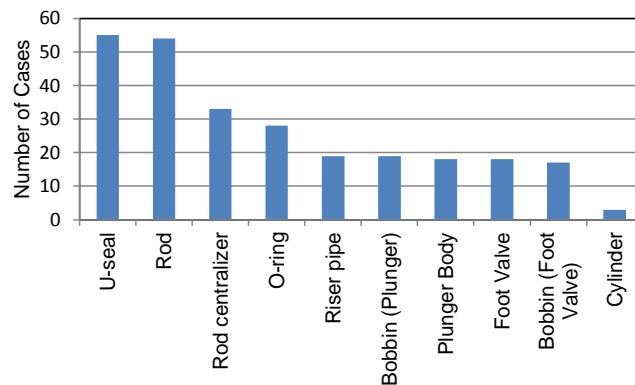

(2) Sediment in Borehole (Siltation)

Sampling of the sediment at the bottom of boreholes was conducted at 28 out of the 300 boreholes surveyed and the analysis results are shown below.

These results indicate that the deposit thickness present were less than 1 m in the majority of boreholes. None of the sampled boreholes have a deposit thickness which covers the screen. A deposit thickness of less than 1 for boreholes which are 15 – 17 years old does not pose a serious problem.

Based on the siltation speed which is estimated based on the actual deposit thickness, clogging of the screen could start in 1 – 3 years' time at these boreholes. There is a similar concern for 5 – 10% of the entire boreholes surveyed.

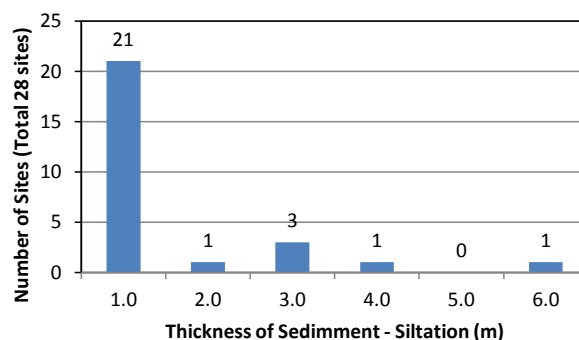

Source: Preparatory Survey Report on the Project for Selected Market Centres and Rural Water Supply in Mchinji and Kasungu District in the Republic of Malawi, February 2012, JICA

O&M schedule

Activity 4.6



Step 1

Facilitator asks the participants how the pump should be properly operated.

Step 2

Facilitator presents the O&M schedule of the Afridev handpump.

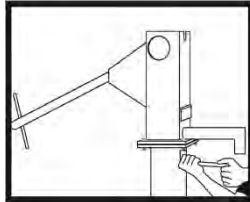
a) Weekly checks by WPC

No.	Item	Materials and Spare parts	Tools and Equipment	Illustration
1	Check that the flange bolts and nuts are tight.	non	Socket spanner	
2	Check that the fulcrum pin and hanger pin nuts are tight.	non	Socket spanner	

b) Monthly checks by WPC

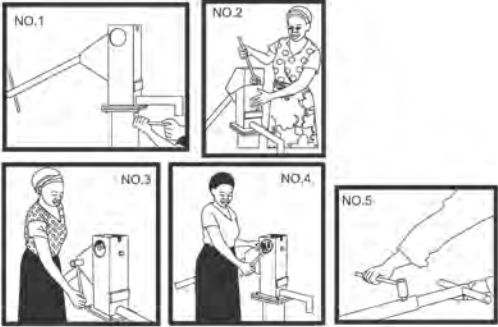
No.	Item	Illustration
1	Check if any fasteners or parts in the pump head are missing. If so, replace the parts.	

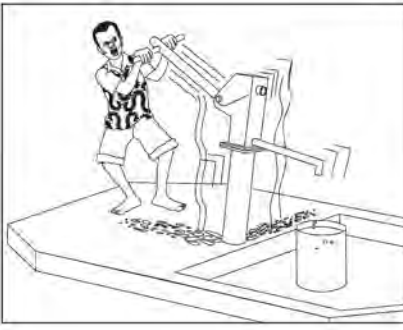
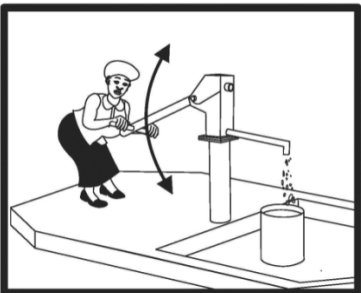
No.	Item	Illustration
2	If any unusual noise is noticed, check reason for the same and take corrective actions.	
3	Check if the pump stand is shaky during operation. If yes, the stand is loose in the foundation and contamination of the well can take place. Take corrective measures to repair the foundation.	
5	Carry out a "Leakage Test" as detailed below.	
6	Carry out a "Discharge Test" as detailed below.	

b-1) Leakage test

A simpler method is to count the number of strokes required before water comes out of the spout on the second pumping. If the number exceeds five strokes then there is an unacceptable leak and the cause should be investigated.

Leakage test should proceed as follows:

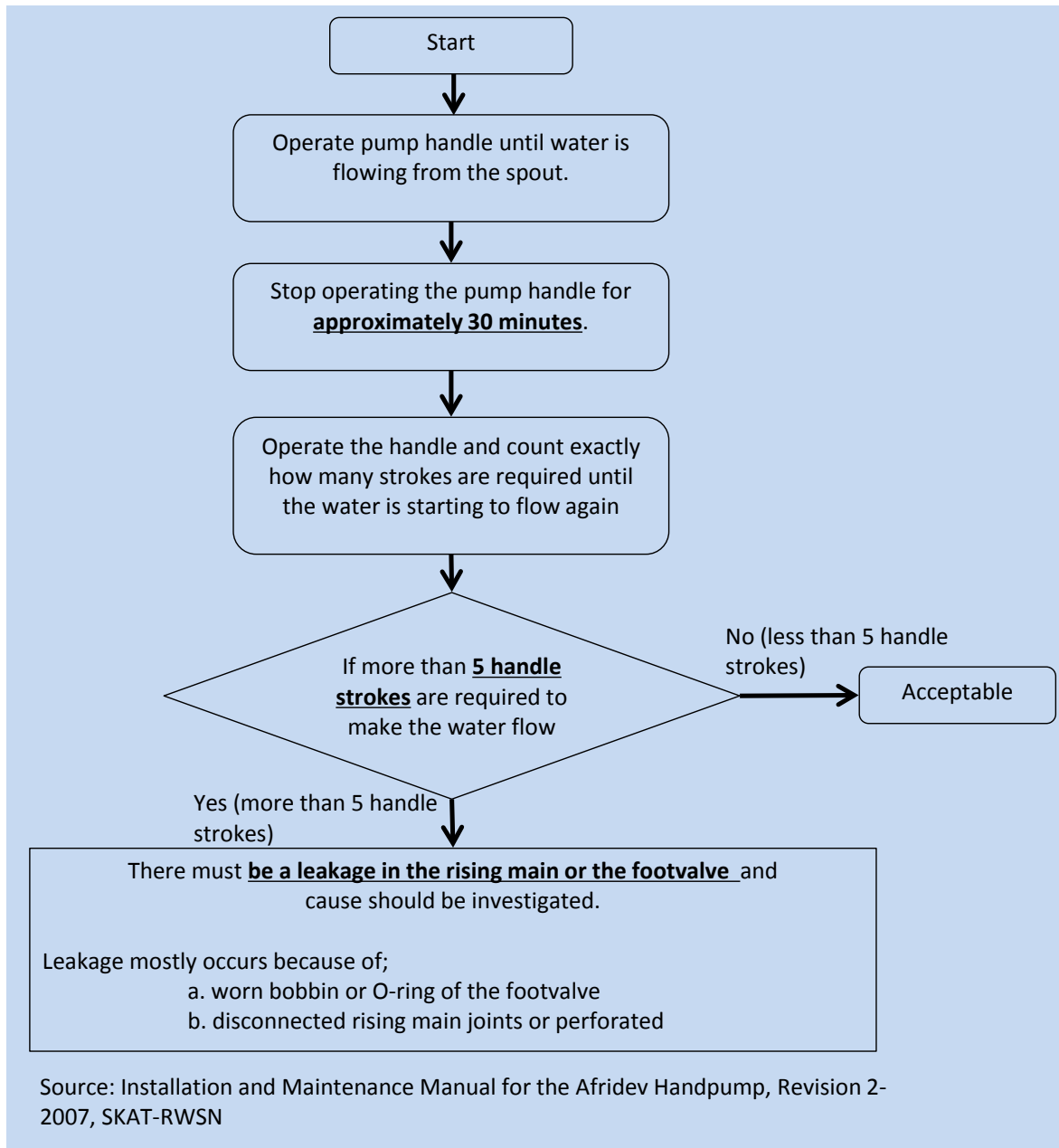

Figure 10: Flowchart for the leakage test

b-2) Discharge test

Collect the water discharged for 40 continuous full strokes and measure the quantity. The discharge should be around 16 litres. If the discharge is less than 10 litres corrective action should be taken. If the discharge is low it could indicate that parts are worn out or that there is leakage.

Discharge test should proceed as follows:

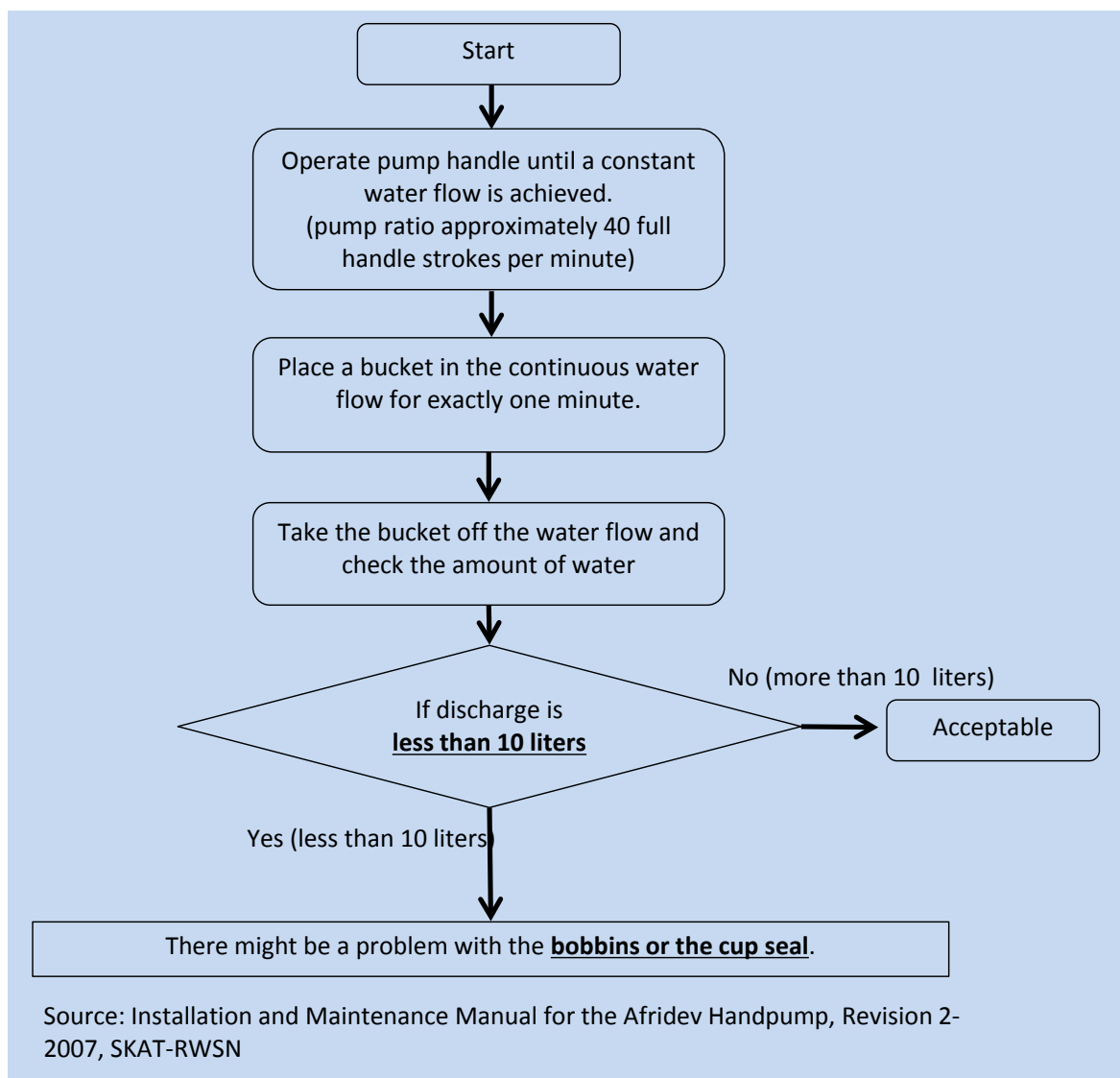

Figure 11: Flowchart for the discharge test

c) Annual checks

c-1) Recommended parts list for replacing every year

- Bush bearing
- U-seal

c-2) Recommended parts list for replacing every two years

- O-ring
- Centralizer
- Cup-seal
- Bobbin

References

SKAT, Revision1-2003. Installation and Maintenance Manual for the Afridev Handpump

Session 5: Trouble Shooting

Introduction

This session aims at imparting knowledge and skills on diagnosis and troubleshooting to enable WPC members to understand how Afridev handpumps are maintained properly.

This topic will provide an overview of the trouble shooting of Afridev handpumps.

Learning Objectives

By the end of this topic, participants will be able to:

1. Understand general operational problems
2. Understand the cause of their problems
3. Understand and describe the remedies of their problems

Tool Kit

Tool 15: Trouble Shooting Booklet (Afridev Handpump Version)

Content

General operational problems, their causes and remedies

Activity 4.7

Step 1

Facilitator asks participants to brainstorm general operational problems and their causes.

Step 2

Facilitator consolidates the discussions and presents general operational problems, their causes and remedies

General operational problems

Category	General operational problems
Water quantity	<ol style="list-style-type: none"> 1. No water discharge 2. Delayed flow of water 3. Reduced discharge water
Water quality	<ol style="list-style-type: none"> 1. Water becomes turbid. 2. Taste becomes salty or water smells
Other	<ol style="list-style-type: none"> 1. Abnormal noise during operation 2. Pump handle is shaky

Cause and remedies

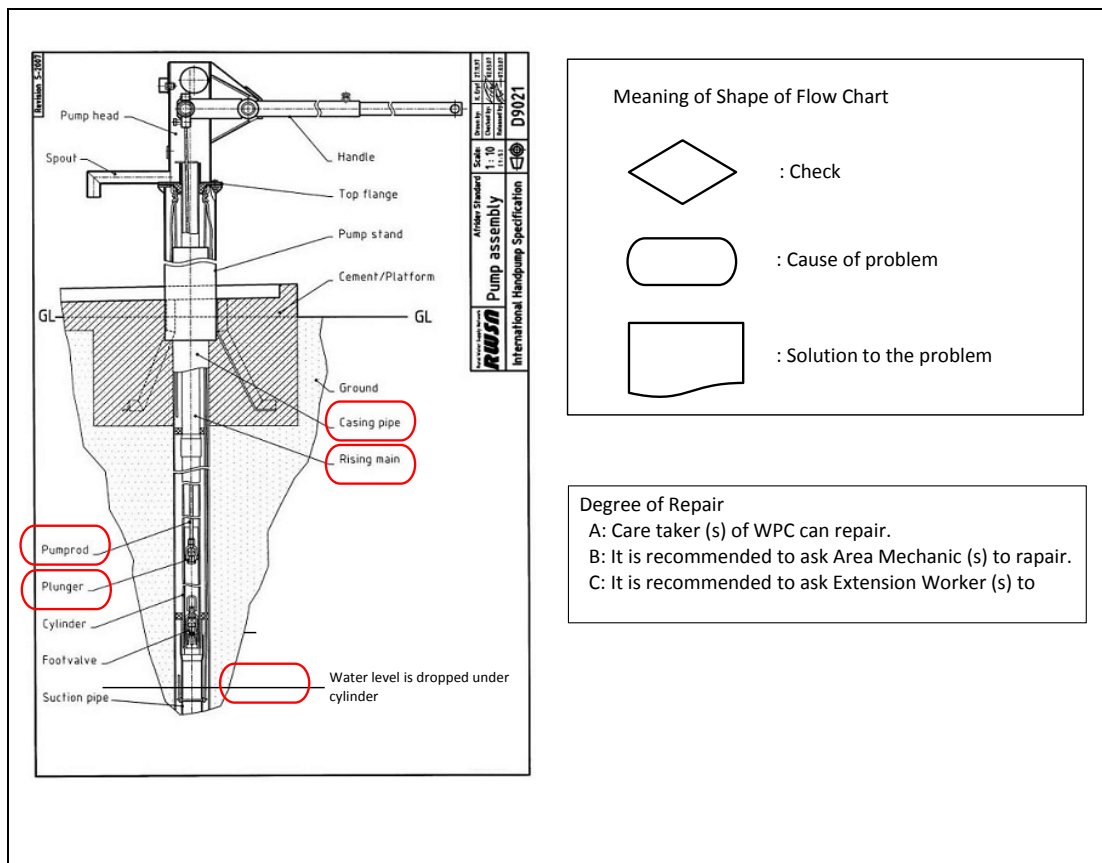
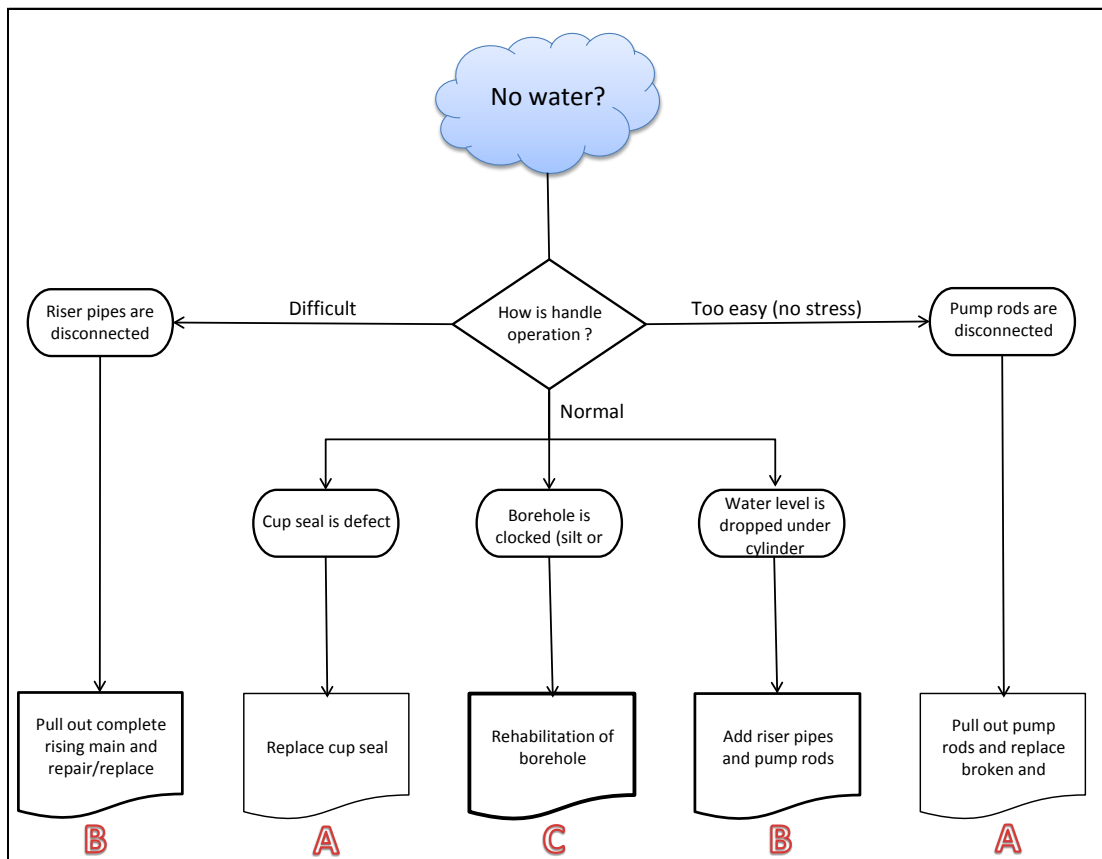

Figure 12: Trouble shooting chart 1 (No water)

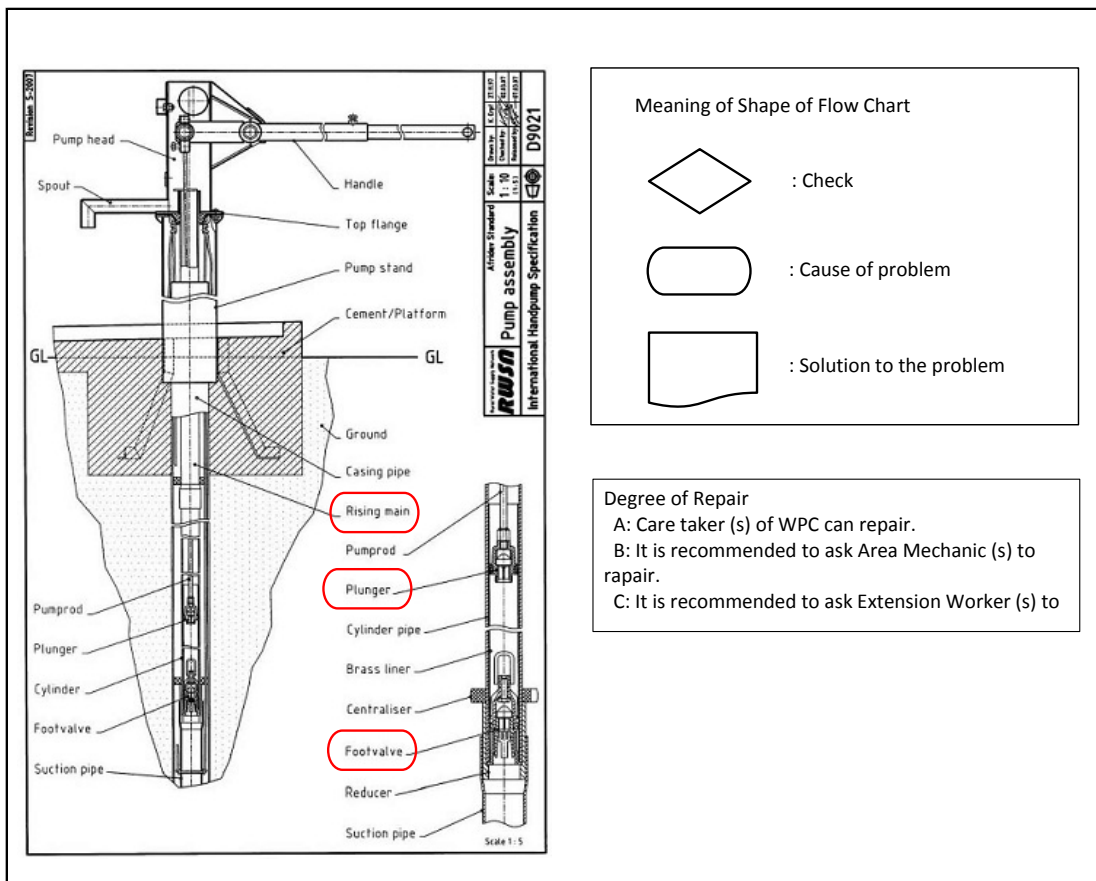
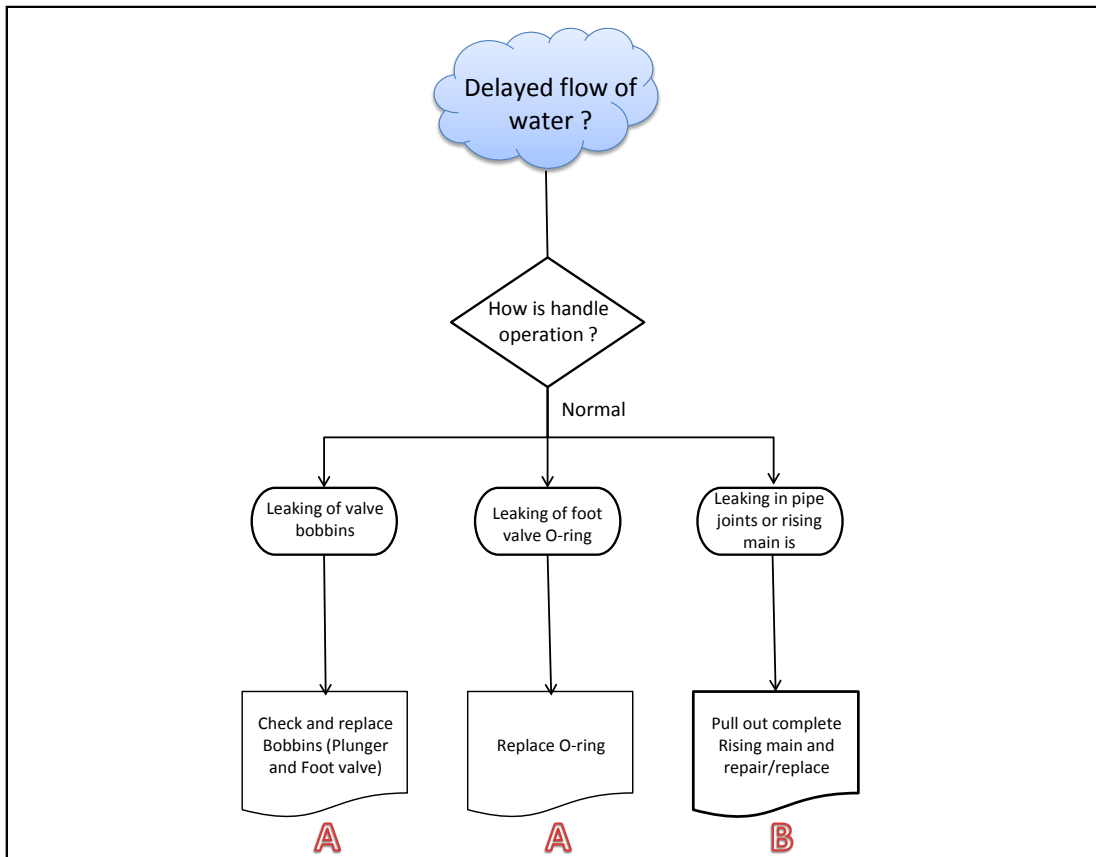

Figure 13: Trouble shooting chart 2 (Delayed flow of water)

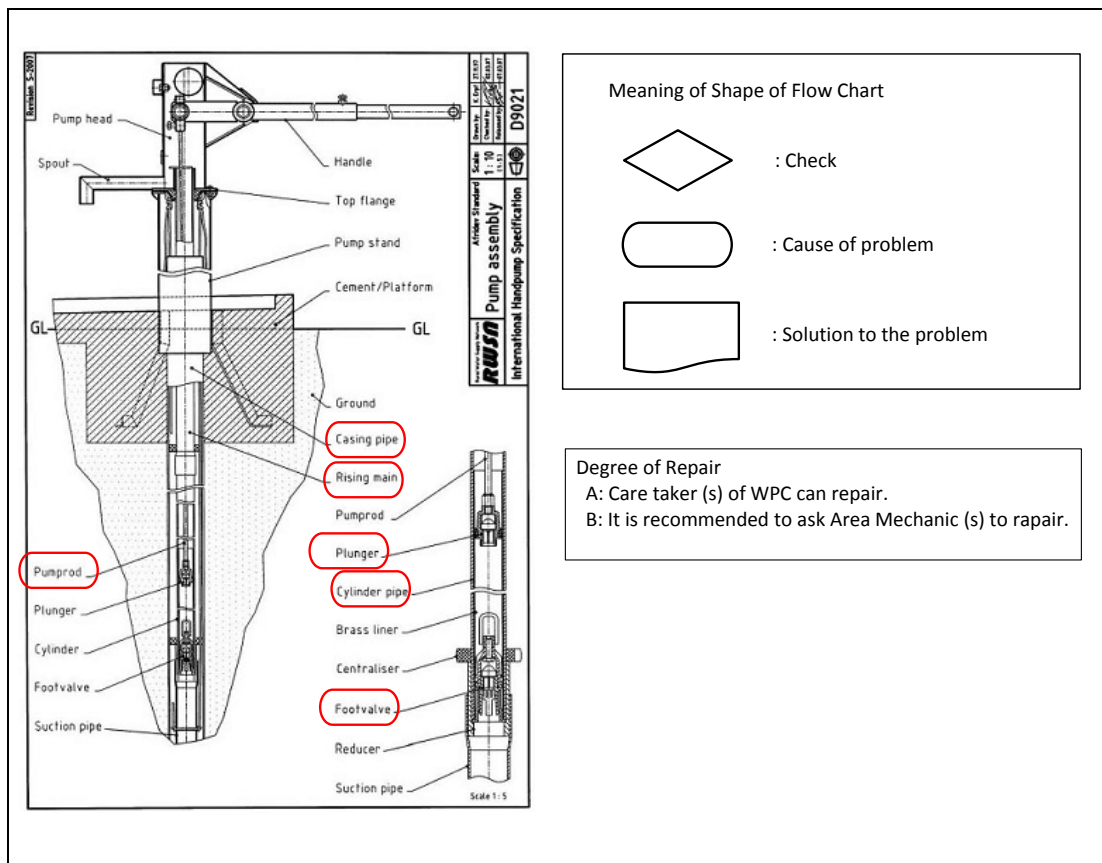
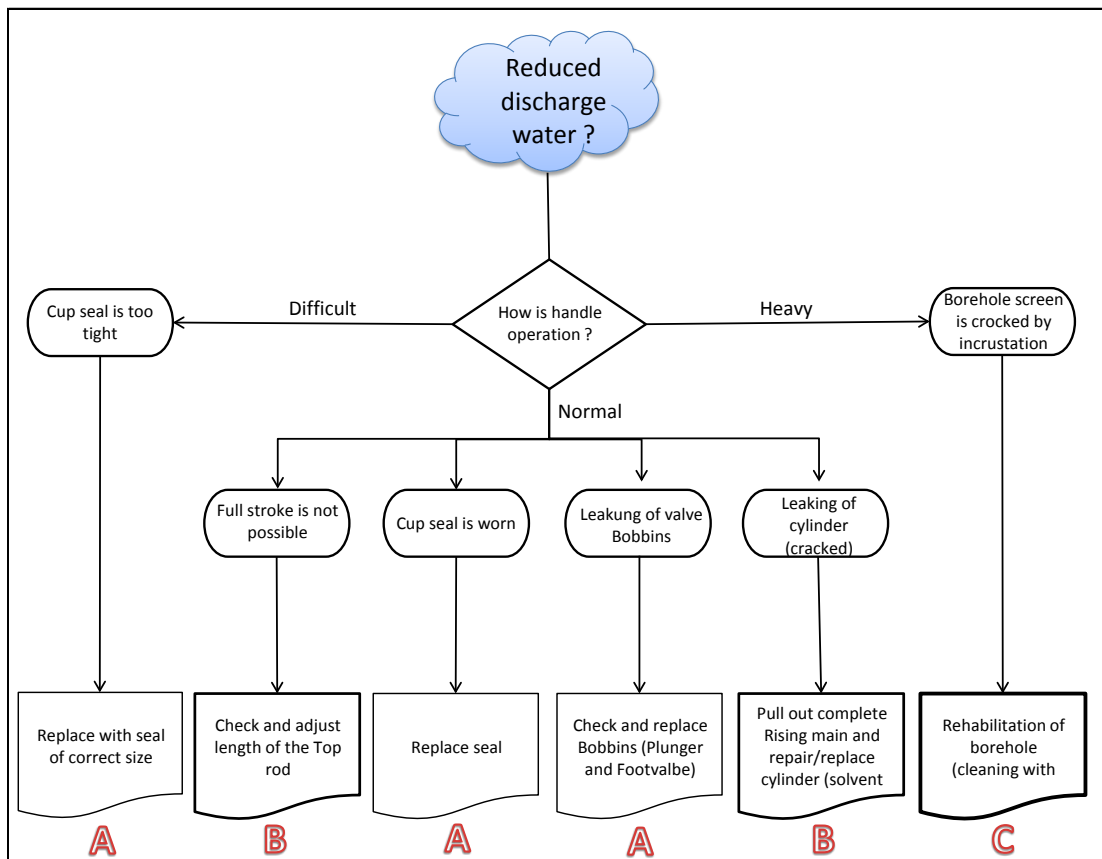

Figure 14: Trouble shooting chart 3 (Reduced discharge water)

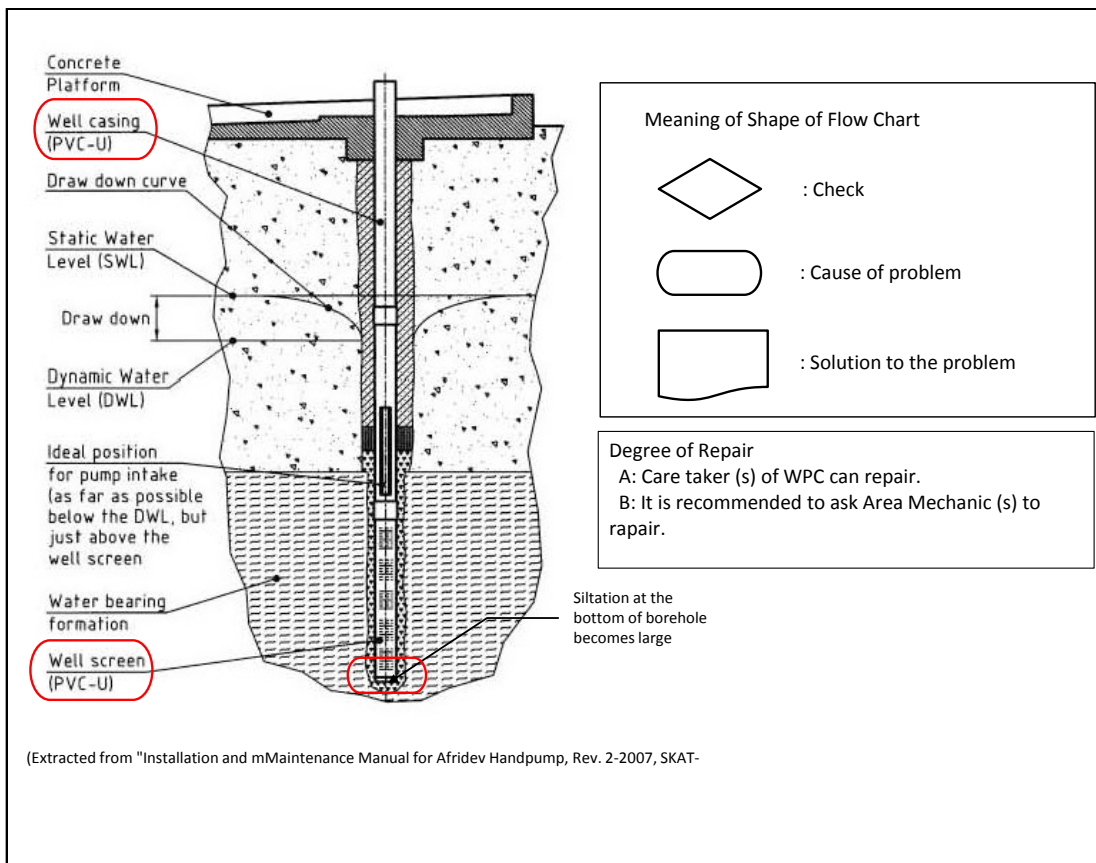
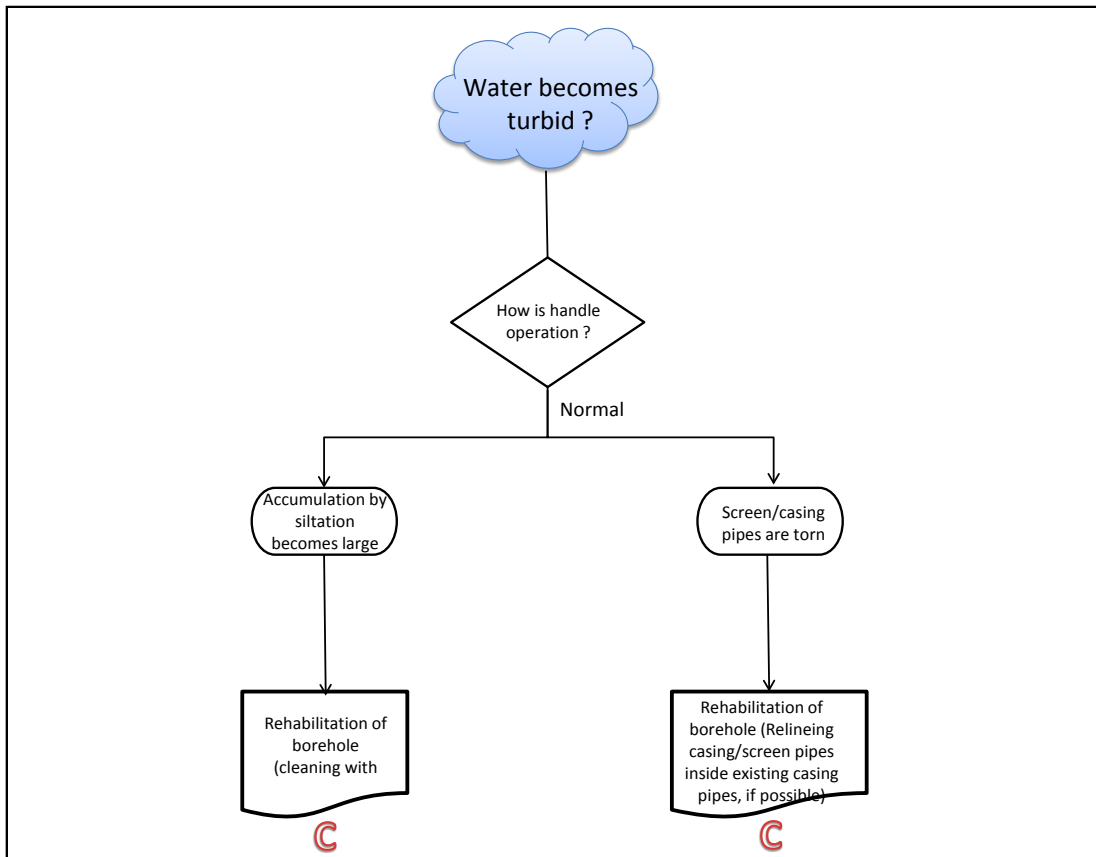

Figure 15: Trouble shooting chart 4 (Water becomes turbid)

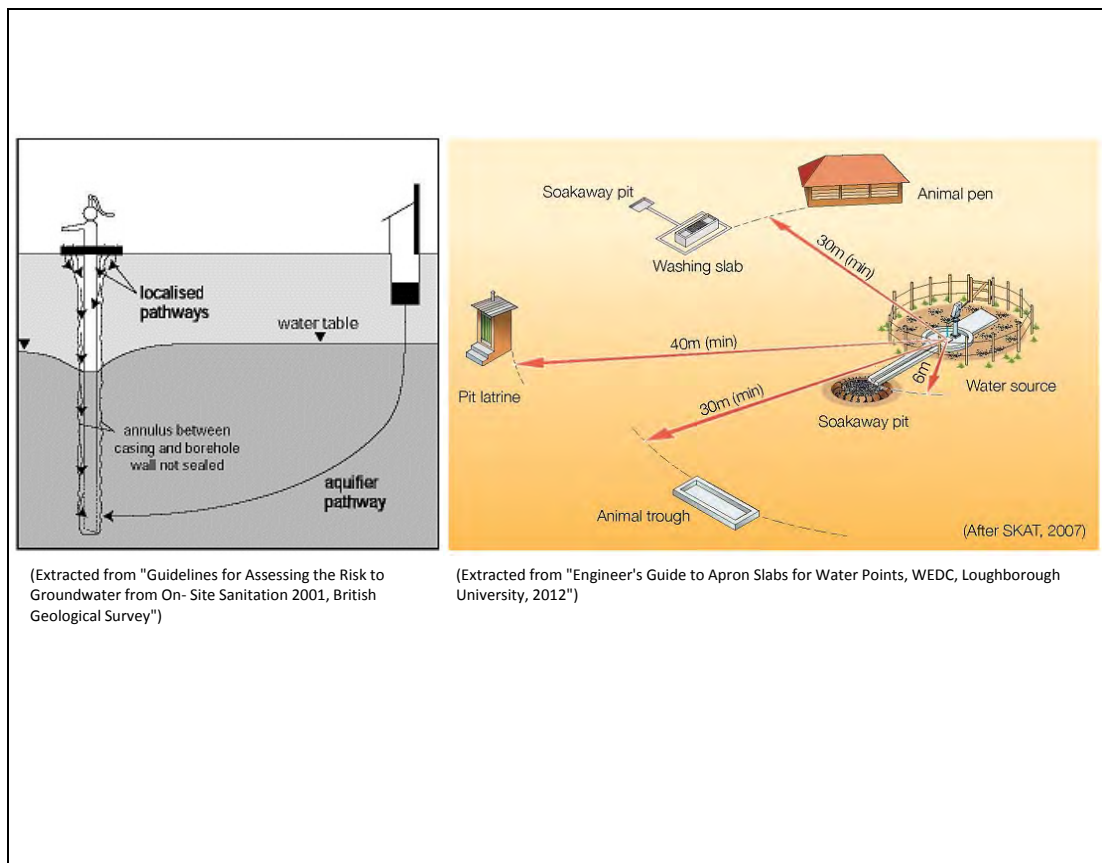
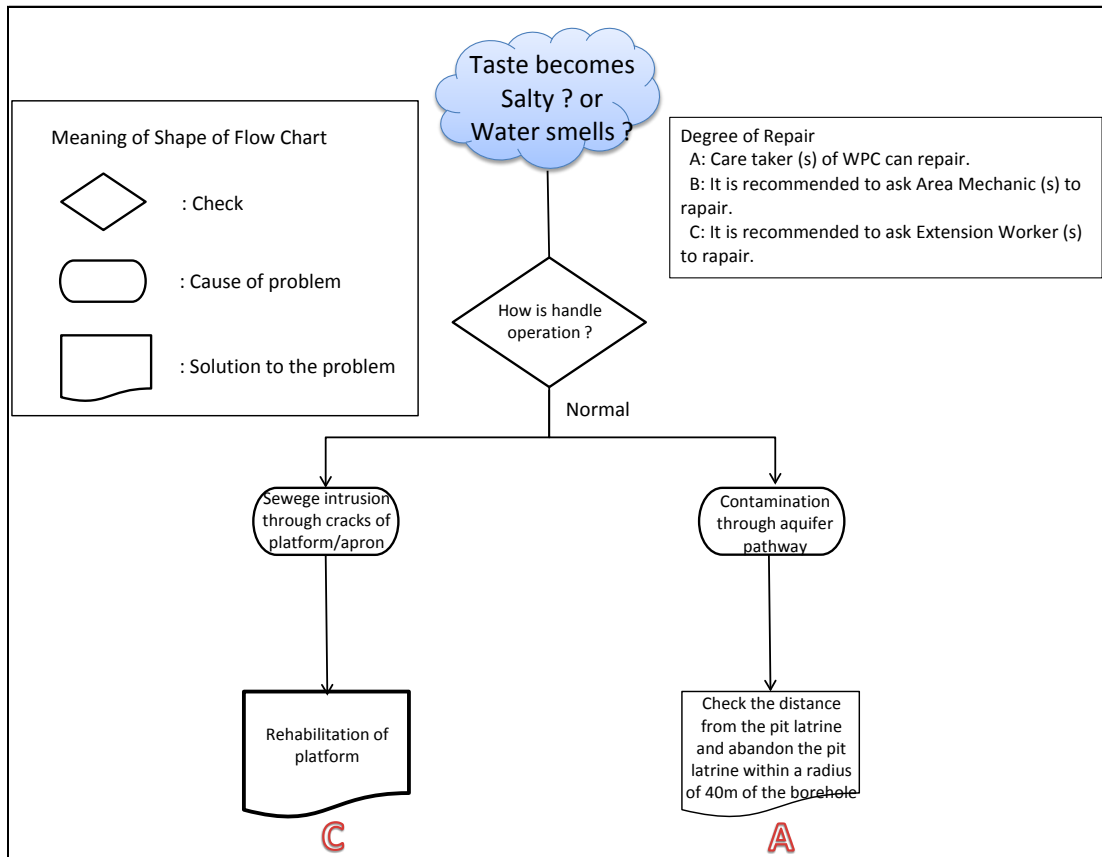

Figure 16: Trouble shooting chart 5 (Taste becomes Salty or Water Smells)

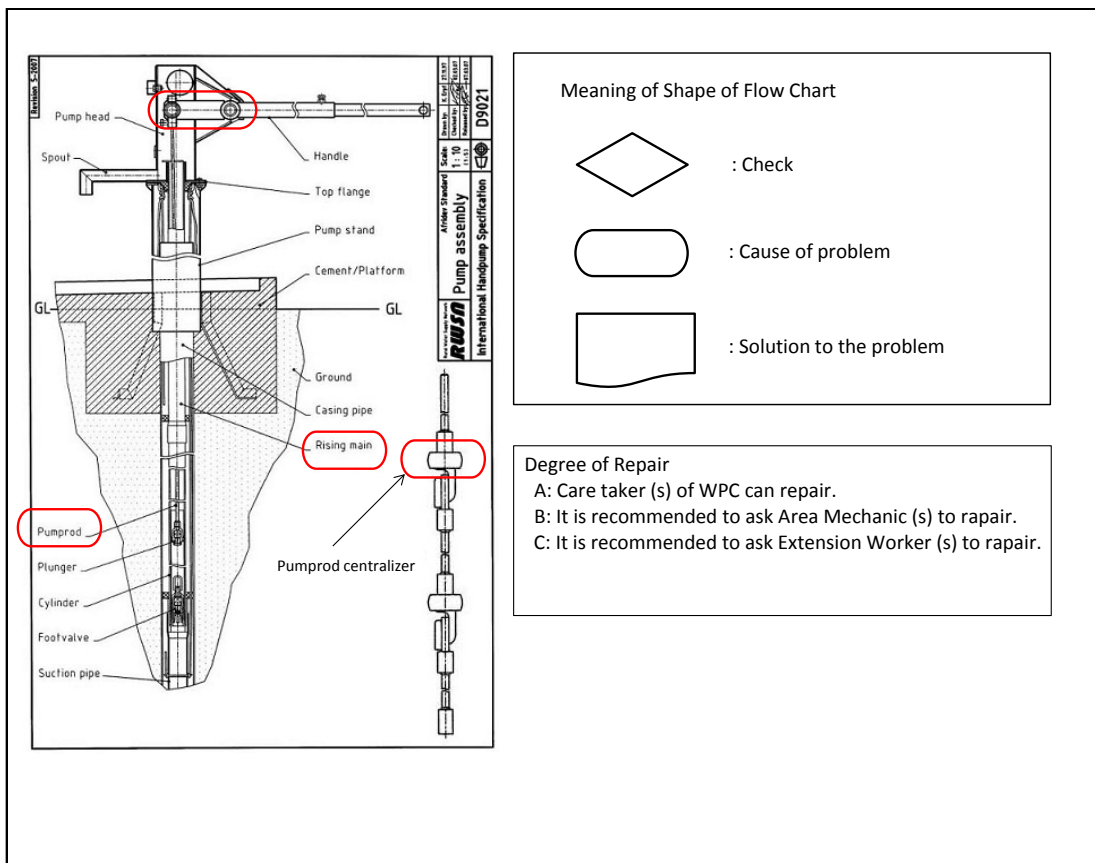
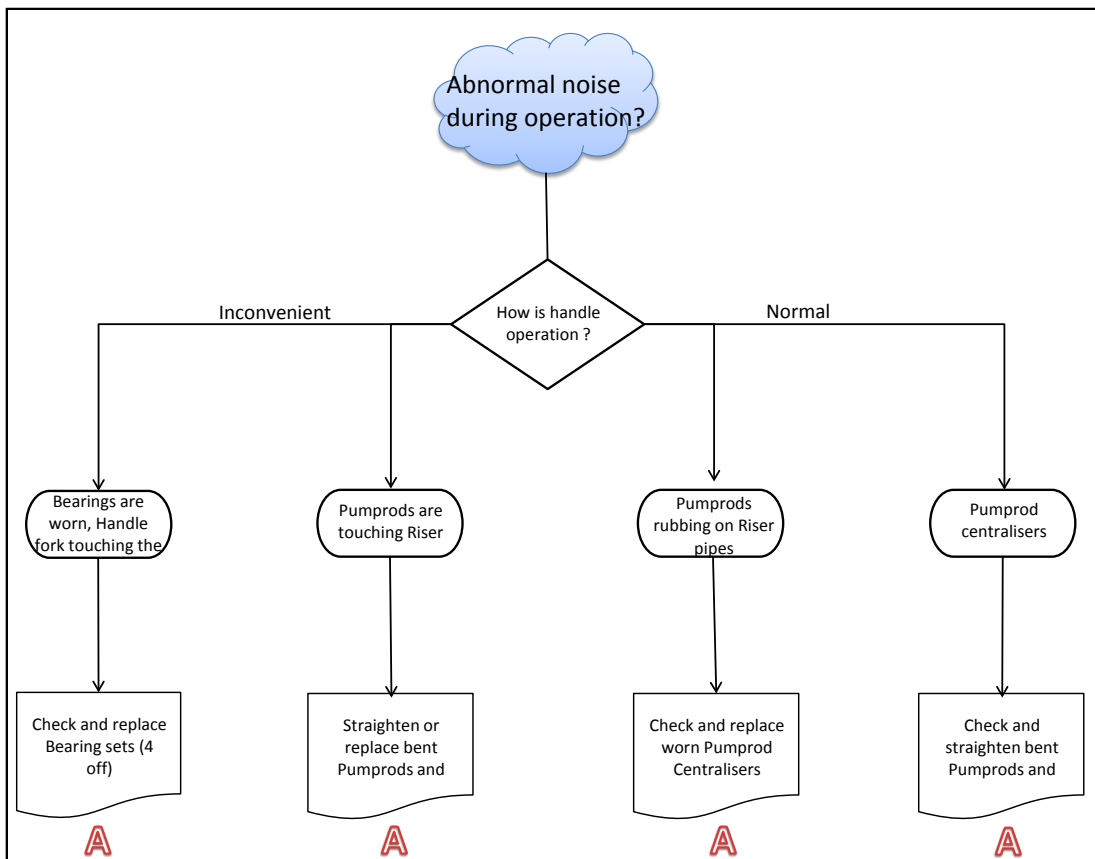

Figure 17: Trouble shooting chart 6 (Abnormal noise during operation)

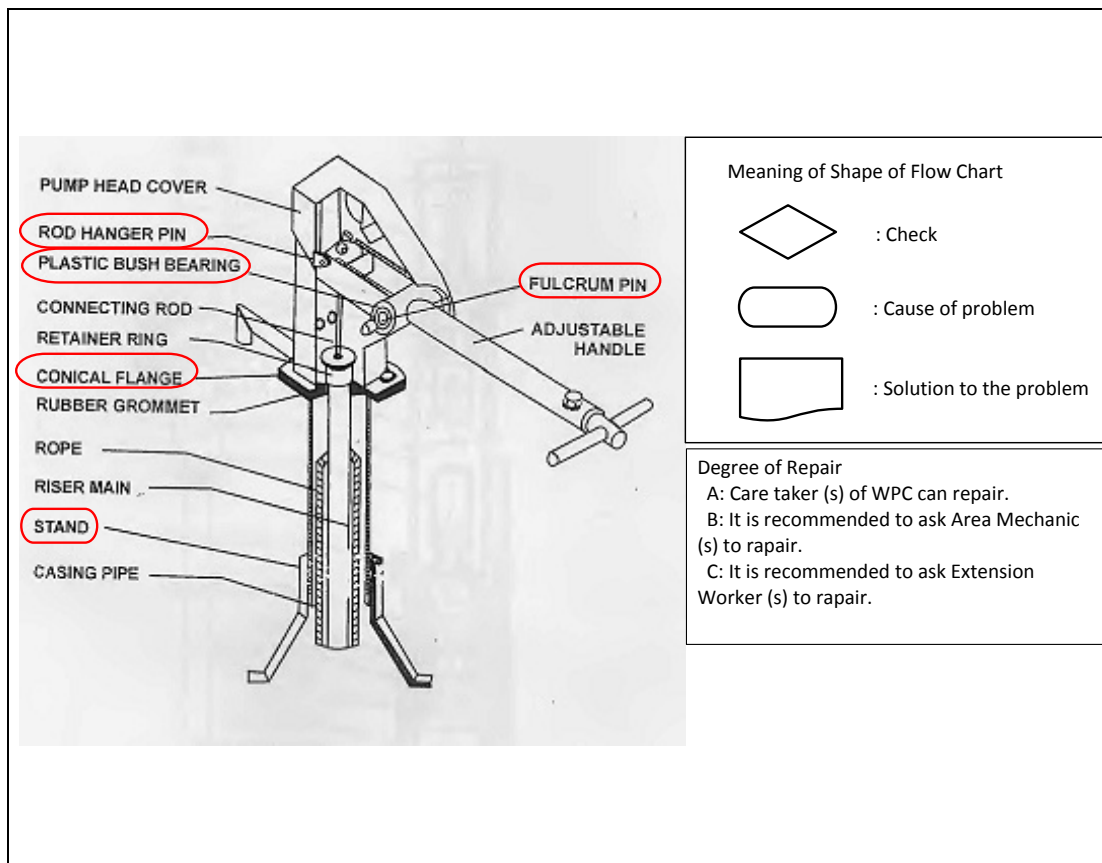
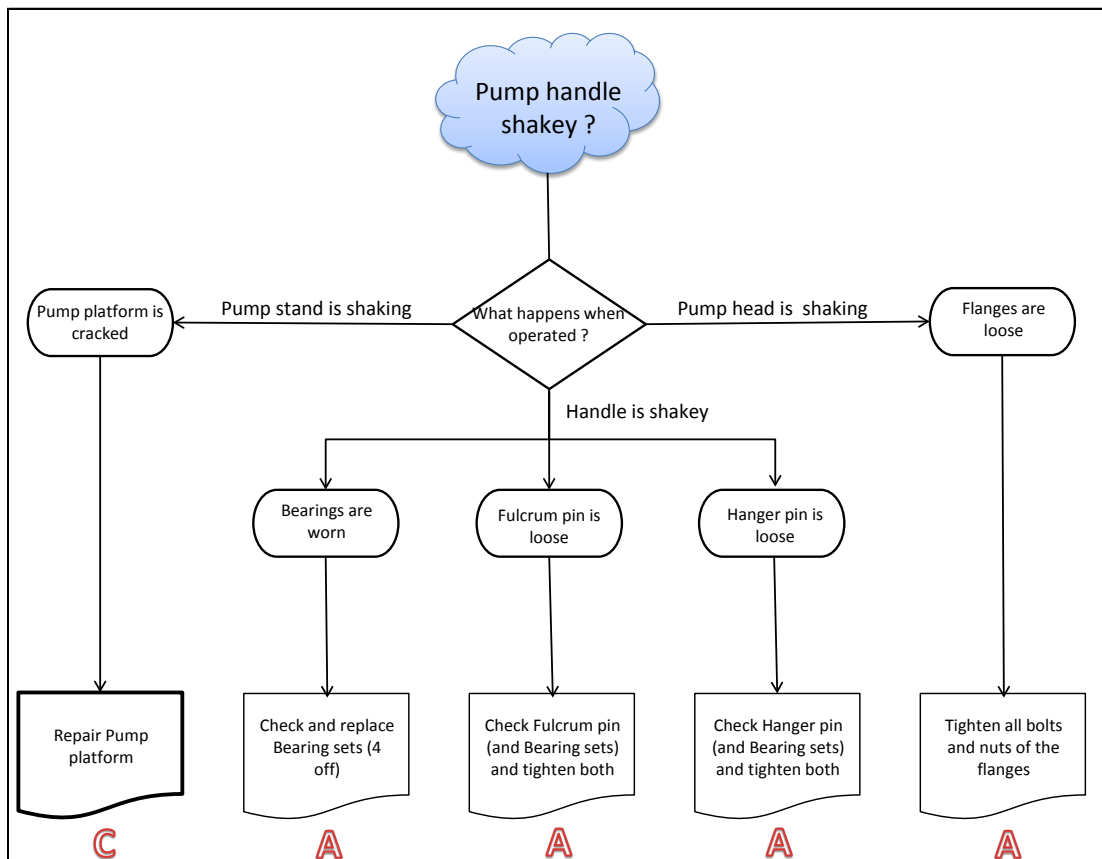

Figure 18: Trouble shooting chart 7 (Pump handle shake)

Demonstration

1) Required materials and tools

- Bucket
- Water
- Cylinder and foot valve with O-ring and bobbin
- Plastic plunger with U-seal and bobbin or brass plunger with cup-seal and bobbin
- Plunger rod



2) Experimental test for understanding the problems and their causes

Case	Situation	Observation	Result
0	Confirm normal conditions	After the up-stroke and down-stroke of plunger-rod, observe the water in the cylinder?	Water condition remains stable.

			
Immerse the cylinder in a bucket of water	Move the rod is up and down in the cylinder pipe	Observe the water moving from lower to upper cylinder	If there is no leakage, the quantity of water (water level) remains the same.

Case	Situation	Observation	Result
1	Remove the U-seal or cup-seal from the plunger	After the up-stroke and down-stroke of plunger-rod, observe the water in the cylinder?	Water flow is delayed.

			
Remove the U-seal or cup-seal from the plunger	Move rod is pushed up and down in the cylinder pipe	Note that the water flow is delayed	





Case	Situation	Observation	Result
2	Remove the bobbin from the plunger	After the up-stroke and down-stroke of plunger-rod, observe the water in the cylinder	Water flow is delayed.

			
Remove the bobbin from the plunger		Move the rod up and down in the cylinder pipe	Note that the water flow is delayed



Case	Situation	Observation	Result
3	Remove the bobbin from foot valve	After the up-stroke and down-stroke of plunger-rod, observe the water in the cylinder	Water leakage from cylinder occurs.

			
Remove the bobbin from the foot valve		Return the foot valve into the cylinder	Move the rod up and down in the cylinder pipe. Note that water leakage from cylinder occurs

Case	Situation	Observation	Result
4	Remove the O-ring from foot valve	After the up-stroke and down-stroke of plunger-rod, observe the water in the cylinder	Water leakage from cylinder occurs.

			
Remove the O-ring from foot valve		The foot valve is returned in the cylinder	Move the rod up and down in the cylinder pipe. Then, Water leakage from cylinder occurs

Case	Situation	Observation	Result
5	Lift up the cylinder pipe from bucket	After the up-stroke and down-stroke of plunger-rod, observe the water in the cylinder	Note that the water unable to be pumped up due to short length of raiser pipe which does not reach the ground water level.

	
The cylinder is kept at a constant height without immersing it under water	Move the rod up and down in the cylinder pipe. Note that water is unable to be pumped up due to the short length of the raiser pipe

References

SKAT, Revision1-2003. Installation and Maintenance Manual for the Afridev Handpump

Session 6: Security System for Afridev Handpumps

Introduction

Afridev pump is a common pump installed in rural communities in Malawi because it is a VL0M pump available in the market. However recently, problems such as theft of Afridev handpump parts and vandalism have been occurring in rural areas.

In order to tackle such issues, government with its partners has introduced a security system for Afridev handpumps.

This session will enable participants to understand the security system for Afridev hand pumps.

Learning Objectives

By the end of this topic, participants will be able to:

1. Describe the different types of locking system for Afridev handpumps
2. Demonstrate the locking system for Afridev handpumps

Tool Kit

Tool 16: Sample Designs for Security System (Afridev Handpump Version)

Content

Different types of locking system for Afridev hand pumps

Activity 4.8



Step 1

Facilitator asks participants to brainstorm why a security system is necessary for the handpumps.

Step 2

Facilitator consolidates the discussions and presents the different types of locking system for Afridev hand pumps.

Different types of locking system

Type	Required materials and tools	Image photo
Locking system 1 for Afridev handpump	<ul style="list-style-type: none"> ➤ Iron bar (Y12) of 1.5m ➤ One 70 mm padlock ➤ Hacksaw and spare blade 	
Locking system 2 for Afridev handpump	<ul style="list-style-type: none"> ➤ Iron sheet ➤ One 70 mm padlock ➤ Hack saw and blades ➤ Grinder 	
Locking system 3 for Afridev handpump	<ul style="list-style-type: none"> ➤ Beater for maize mill or Iron sheet ➤ One 50mm padlock ➤ Hack saw and blades 	

How to install the locking system on the handpump

Installation method for above locking system is as shown in Tool 16.

Module 5: Roles of Different Players

Introduction

This module provides a general overview of the Water Point Committee's role in managing water points including organisational arrangements, roles and responsibilities of various stakeholders.

This module will help participants to become familiar with the roles of different players for O&M of water points.

Objectives

By the end of this topic, participants will be able to:

1. Identify all the different players
2. Understand roles and responsibilities of different players

Content

The module covers the following sessions:

Session 1: Roles and responsibilities of the community

Session 2: Roles and responsibilities of other stakeholders

Session 1: Roles and Responsibilities of the Community

Introduction

The main purpose of forming a WPC is to empower water users to run their own water point with full cost recovery to ensure sustainability. The process of establishing a WPC promotes community ownership of the O&M of the water point, control over finances and other resources and ensures equitable distribution of the water supply and sanitation services to meet economic and social needs of the water users.

This topic will equip participants with knowledge of the organisational structure of the community including the WPC.

Learning Objectives

By the end of this topic, participants will be able to describe the roles and responsibilities of the community

Content

Roles and responsibilities of the community

Activity 5.1

Step 1

Facilitator divides participants into small groups to discuss the roles and responsibilities of one player related to the O&M activities and prepare its presentation.

Step 2

Facilitator asks participants to make a presentation on the roles and responsibilities of the selected player and discuss with all of the participants.

Step 3

Facilitator consolidates the discussions and presents the roles and responsibilities of the community properly.

User Community

- Identifying, prioritising and assessing community needs and asking for assistance.
- Attending to community meetings
- Electing members of WPC and or Area Mechanics (AMs)
- Choosing type of water facility and site
- Mobilising resources including cash contributions and deciding on how funds for maintenance of facility should be managed
- Providing communal labour and local materials for construction of water facilities
- Agreeing on rules for use of new or old water supply facilities
- Maintaining a clean environment around the facility

- Participating in hygiene and sanitation promotion
- Protecting catchment areas
- Protecting water and sanitation facilities
- Monitoring the water and sanitation facilities

Water Point Committee (WPC)

- Conducting community meetings to brief them on plans or problems about water facilities
- Leading the community in planning and helping to build Water and Sanitation facilities
- Taking responsibility to operate and maintain new and existing facilities
- Raising and managing funds and other resources for the water point
- Keeping records of meetings, money raised, money spent and repairs
- Hiring and signing contracts with AMs and other service providers, supervising and monitoring their activities and signing off on completed work
- Organizing maintenance and repairs carried out by caretakers and other service providers
- Organizing communal labour for site cleaning and maintenance
- Facilitating education and planning on water, sanitation and hygiene and other cross cutting issues including HIV and AIDS, gender and environment
- Monitoring and evaluating activities and analyse results and using these to improve management
- Purchasing hand pump spare parts for repairs from selected spare parts retail shops

Village Health & Water Committee (VHWC)

- Organise VHWC and community meetings on water , sanitation hygiene and other cross cutting issues including gender, environment and HIV and AIDS
- Identifying needs for water and sanitation facilities in the community and help user communities to prepare application proposals
- Coordinate with WPCs
- Plan WASH activities for the whole village
- Facilitated hygiene & sanitation education
- Set village bye-laws on WASH
- Mobilise funds and other resources for WASH activities.
- Monitoring and evaluation (M&E) of WASH activities
- Sensitizing the communities on the need to purchase hand pump spare parts for repairing the hand pump

Session 2: Roles and Responsibilities of Other Stakeholders

Introduction

In order to implement water and sanitation activities effectively, there is a need for the supreme organs of WPC to use existing institutions and organisations at community, district, regional and national levels. Identification of these stakeholders and an understanding of their respective roles and responsibilities will assist in the sustainable management of the water point.

This topic provides an overview of the roles and responsibilities of relevant stakeholders in the operations of WPC.

Learning Objectives

By the end of this topic, participants will be able to describe the roles and responsibilities of the other stakeholders.

Tool Kit

Tool 17: Sample of Contract between WPC and AM

Content

Roles and responsibilities of the other stakeholders

Activity 5.2

Step 1

Facilitator asks participants to brainstorm the roles and responsibilities of the other stakeholders

Step 2

Facilitator consolidates the discussions and presents the roles and responsibilities of the other stakeholders

Traditional Leaders

- Fostering community participation and mobilization
- Facilitate regular elections of VHWC/WPC
- Monitor the work of VHWC and WPCs
- Problem solving and conflict resolution
- Recommending candidate retail shop owners at the trading centre in Traditional Authority (TA) to District Water Development Officer (DWDO)
- Advertising the hand pump spare parts retail shops (SPRSs) which are selected by the district to the communities through Are Development Committee (ADC) meetings

Extension Workers (EWs)

1) Water Monitoring Assistant (WMA)

- Assisting in the establishment of the AM system where required, e.g. during training

- Conducting field visits to monitor AMs
- Conducting meetings with AMs on a monthly or quarterly basis
- Keeping records of area mechanics activities
- Reporting on AM activities to the DWDO
- Where possible, introducing AMs to their fellow SPRSs
- Helping community establish a system for O&M
- Conducting training of SPRS owners
- Train WPC and VHWC
- Checking the quality and quantity of the spare parts at retail shop and customer levels
- Monitoring of stock sells and selling price of hand pump spare parts at retail shops
- M&E of water and sanitation activities for communities

2) Health Surveillance Assistant (HSA)

- Help the community to develop hygiene education messages and promoting sanitation activities
- Train WPC and VHWC
- M&E of water and sanitation activities for communities

3) Community Development Assistant (CDA)

- Build active participation of women, men, girls and boys and all sectors
- Train WPC and VHWC and caretakers
- Help the community establish a system for raising and managing money
- Help the community establish a system for raising and managing money for O&M
- M&E of water and sanitation activities for communities

District Water Development Officer (DWDO)

- Planning for the establishment of hand pump spare parts retail shops (SPRSs) in a district
- Calculating budget which is necessary to carry out the support of the hand pump spare parts supply chain and to request budget from the district
- Requesting from ADC about the candidate retail shop owners who sells the hand pump spare parts
- Confirming the willingness of the retail shop owners to sell hand pump spare parts
- Planning retail shop owner training
- Providing starter packs to selected hand pump spare parts retail shops
- Providing advertising materials/tools
- Advertising the hand pump SPRSs which are selected by the district to the communities and AMs
- Advertising to the communities and AMs
- Preparing the warehouse at the district level to stock the spare parts received from the regional level warehouse
- M&E of WASH activities in a district

District Coordination Team (DCT)

- Plan and coordinate WASH activities in a district
- Promote new CBM approaches in a district
- Develop data base on WASH
- Select and prioritise target communities
- Train and support/supervise field workers
- Appraise of facility management plans (FMPs)
- Select, train and supervise LSPs
- M&E of WASH activities

Area Mechanic (AM)

An AM is a private technician who can repair major problems of hand pumps. They check the condition and/or repair water supply facilities based on a contract with the WPC.

The technical services include the repair works of hand pumps. Therefore AMs should provide services that are sustainable and at a reasonable price.

1. How can an AM be identified?

The AMs should be identified through an ID which shows their photo and the number of the area they work in, Traditional Authority and signed by DC. The ID will expire within a period of three years after which it will be renewed.

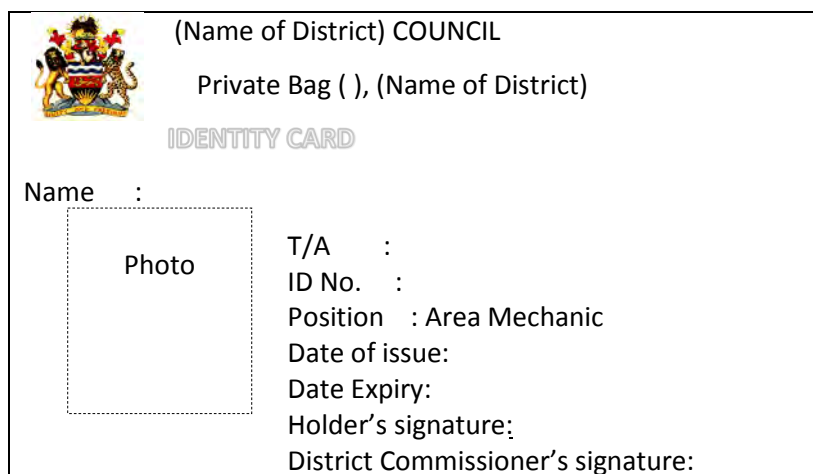

Figure 19: Sample of ID for AM

2. Why having a contract with an AM?

WPC should have a contract with an AM so that the AM can:

- Report major breakdowns to WMA/ DWDO
- Repair breakdowns that cannot be handle by WPC’s care takers.
- Help the DWDO in monitoring functionality of hand pumps

3. Type of contracts and fees (See Tool 17)

There are two types of standard contract, a maintenance contract and a repair contract. The fee should be reasonable and charged in agreement with WPC.

Details of these two types of contract are as follows.

Maintenance contract (Preventive contract)

This type of contract is for one year and the AM should visit the water point at least 4 times in a year for maintenance of the hand pump.

The fee for the contract is MK4, 500 per annual payment (as of 2014).

The contract fee should be revised from time to time based on the current rate of inflation.

Repair contract (Breakdown contract)

This type of contract is signed whenever there is a breakdown of the hand pump and the WPC has not signed a maintenance contract with the AM.

The fee for this contract should be set and agreed with the WPC at a standard price according to the type of repair.

4. Roles and responsibilities

- Maintaining trust with the WPC
- Providing technical services to the WPC at a fee based on a signed contract
- Contacting a supervising WMA or DWDO when in need of technical assistance to perform repairs
- Maintaining skills through self-study
- Maintaining all tools, transportation and communication methods to be used in providing repair services
- Reporting their activities to a supervising WMA or DWDO on a monthly or quarterly basis

Spare Parts Retail Shop (SPRS)

These are shops identified in the busy trading centres and are provided with a starter pack of hand pump spare parts to sell to the WPCs.

Spare parts shop owners are a vital component in accessibility of Afridev handpump spare parts in the rural areas of the country.

Their strategic position in the supply chain is of importance in ensuring the sustainability of the O&M of hand pump by WPC.

1. Roles and responsibilities

- Purchasing the hand pump spare parts from the wholesaler
- Stocking enough quantity of the hand pump spare parts to supply spare parts to WPC constantly
- Selling the hand pump spare parts at a standardized price to the WPC
- Procuring good quality hand pump spare parts
- Working hand in hand with AMs to ensure access to relevant spares, and to cross promote the services of both AMs and retail shops in the same area.

2. Stock that can be found in a retail shop

A starter pack is initial stock for a spare parts retail shop to start its business and to raise a revolving fund for the costs of shop operation and replenishment.

The starter pack is provided from the district to selected retail shops if funds are available. The pack includes:

- i. Fulcrum pin assembly
- ii. Bearing bush outer
- iii. Bearing bush inner
- iv. Pump rod assembly
- v. Rod centralizer
- vi. Rising pipe
- vii. Valve body assembly (plastic)
- viii. Bobbin
- ix. Cup-seal
- x. O-ring
- xi. U-seal
- xii. Double end socket
- xiii. Solvent cement
- xiv. Bolts and nuts 12 x 40
- xv. Standard display shelf

References

Ministry of Water Development (1999), Trainers guide for Extension workers manual

Ministry of Agriculture, Irrigation and Water Development (2015), Guide Manual for the Establishment and Management of an Area Mechanic System

Ministry of Agriculture, Irrigation and Water Development (2015), Guide Manual for the Establishment of an Afridev Hand Pump Spare Parts Supply Chain

Module 6: Planning for Operation and Maintenance

Introduction

WPC together with the communities have a responsibility to develop an O&M plan to qualify to be given water supply facilities. However, very few WPC actually have an O&M plan. Even if they have one, it may not be updated regularly. As a result, issues of inadequate management such as a low level of fund raising, inadequate construction of sanitary facilities and irregular implementation of scheduled maintenance by the community were found to be common with most WPCs. In order to ensure continuous reliable operation throughout the lifetime of the facility, it is important to have an O&M plan.

This module will equip the WPC members with knowledge and skills on how to develop the O&M plan using a template of the facility management plan (FMP).

Objectives

By the end of this module, participants should be able to:

1. Understand Community Action Cycle
2. Develop a facility management plan

Content

This session contains the following topics:

Session 1: Community Action Cycle

Session 2: Facility Management Plan.

Session 1: Community Action Cycle for O&M

Introduction

The Community Action Cycle for O&M needs to be introduced to the community in a timely manner to stimulate and motivate community participation for the purpose of instilling ownership and sustainability. The cycle includes four common phases as interrelated parts of a complete management procedure. Experiences and lessons learned through such a process of four common phases should be applied for the planning of future stages.

Learning Objectives

By the end of this topic, participants will be able to describe the activities to be carried out during each phase of the Community Action Cycle

Content

Community Action Cycle

Activity 6.1

Step 1

Facilitator asks the participants to brainstorm about management cycle on O&M.

Step 2

Facilitator summarises the discussion and provides the management cycle on O&M.

The four common phase of Community Action Cycle

1. Mobilization
2. Planning for O&M
3. Implementation
4. Monitoring and Evaluation

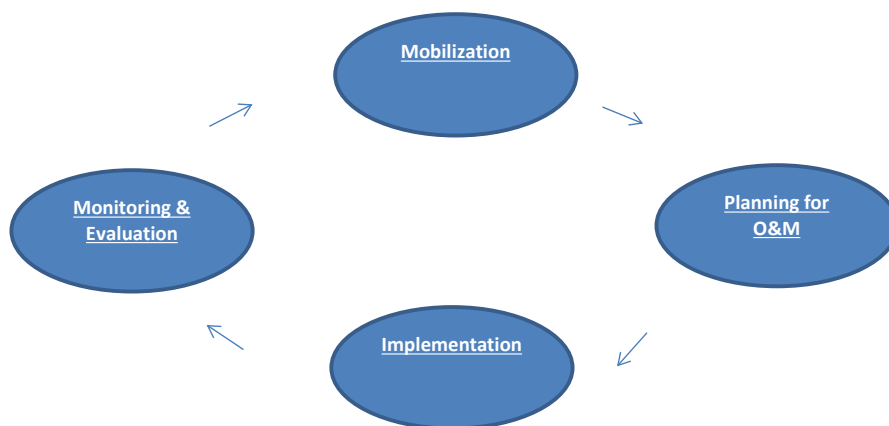

Figure 20: Community Action Cycle for Operation and Maintenance

Minimum activities at each phase

Four phase	Activities by the communities (WPC and users)	Activities by the EWs
Mobilization (See details in Community Mobilization Module 8)	<ol style="list-style-type: none"> 1) Meet village head and village leaders 2) Hold meeting with communities 3) Discuss O&M problems and solutions 	<ol style="list-style-type: none"> 1) Support to hold the meeting with the whole community 2) Introduce their work and the role of the ministry and district officials 3) Participate in village meetings organized by the community
Planning for O&M	<ol style="list-style-type: none"> 1) Discuss / review the Facility Management Plan (FMP) with the whole community at least once a year 2) Develop the action plan with communities based on the FMP 	<ol style="list-style-type: none"> 1) Support to develop / review the FMP and action plan
Implementation	<ol style="list-style-type: none"> 1) Conduct activities based on the action plan 2) Write reports on their field work and report progress to EWs 	<ol style="list-style-type: none"> 1) Supervise activities conducted by the communities and provide technical support and recommendations 2) Review and provide feedbacks to report provided by the WPCs/VHWCs
Monitoring & Evaluation (See details in Module 9)	<ol style="list-style-type: none"> 1) Conduct participatory monitoring of community progress 2) Identify problems and potential conflicts 3) Provide feedback of monitoring and progress on activities to the whole community through village meetings (back to the Mobilization phase) 	<ol style="list-style-type: none"> 1) Advise the communities on the way forward 2) Assist communities in solving their problems, monitor progress and provide feedback to WPCs/VHWCs

References

Ministry of Health, May 2009, Health Surveillance Assistant Facilitator's Guide

Ministry of Water Development, 1999, Trainer's Guide for Extension Worker Training

Session 2: Facility Management Plan (FMP)

Introduction

A Facility Management Plan (FMP) explains the type of water facilities, ways of raising O&M funds (water tariff) for the management and maintenance of new and existing water facilities, planning for hygiene and sanitation promotion activities, identification of members of the WPC, and other relevant information required for the proper management of water facilities.

Learning Objectives

By the end of this topic, participants will be able to:

1. Discuss the outline of the FMP
2. Describe the outline of Action Plan
3. Develop a FMP

Tool Kit

Tool 18: Facility Management Plan Form

Tool 19: Action Plan Form

Content

Facility Management Plan (FMP)

Activity 6.2

Step 1

Facilitator asks the participants to brainstorm what is necessary for planning O&M.

Step 2

Facilitator consolidates discussions and presents a definition and contents of facility management plan.

Definition of FMP

Facility management plan is a plan showing how the water facility will be maintained and sustained to ensure continuous reliable operation over a period of time.

Contents of FMP

The FMP should include at least the following components:

a) Description of Water Facility

District
TA
Village
Borehole No./Identification

Total Population of Communities using Borehole
Total Number of Households using Borehole
Number of Public Institution (s) using Borehole
Total Population of Public Institution (s) using Borehole
Name of Public Institution (s)

b-1) Water User Committee (Village Health Committee and/or Water Point Committee)

Name of Committee member
Sex
Position on the committee
Responsibilities of that person
Date Elected

b-2) Other Focal People Concerned

Name of Committee member
Sex
Position on the committee
Responsibilities of that person
Date Elected

c) Facility Plan

Facility
Requirements (personnel, equipment, funds)
Planned completion of work

d) Regulations of Water User Committee

Users responsibilities (including duty roster on sanitation at borehole)
Water tariff setting
Way of keeping funds safe

e) Activity and Expenditure Plan

Component	Management
	Maintenance
	Environmental management
Activity	Community and VHWC/WPC meetings to check progress
	Updating of user list and other records
	Monitoring and follow-up
	Annual planning
	Routine/preventive maintenance
	Purchase of spare parts
	Signing of contracts with Area Mechanics
	Fencing of borehole
	Planting vegetation
	Making and clearing out drains
	Making and caring of soak away pit
	Sources of pollution (distance of latrine, rubbish pit, animal cage, animal kraal, grave yard and garden from borehole)
Frequency	
Requirements (Personnel, Equipment, Funds)	

Cost incurred

e) Annual Account Book

Cash
Bank
Balance

h) Signature

Signature by WPC
Date

Creation of the FMP

Soon after the WPC has been formed and trained, discussions for the development of a FMP can start.

Each community should develop a FMP with support from their EWs. This plan shall be verified for its viability before a new water point is constructed and shall be reviewed once a year by the communities.

Activities	When	Who
Draft a FMP (original version)	During the CBM 1 (pre-construction)	WPC & community
Review the original version of the FMP and finalize in agreement with the community	At Least once a year	WPC & community

Action Plan

Activity 6.3

Step 1

Facilitator divides participants into groups to discuss the content of an action plan

Step 2

Facilitator consolidates the responses and outlines the content of the action plan.

Step 3

Facilitator asks participants to practice developing an O&M action plan of their own.

Step 4

Facilitator asks participants to make a presentation of their action plan and gives feedback to the participants.

Definition of Action Plan

An action plan is a document that lists what steps must be taken to achieve a specific goal. The purpose of an action plan is to clarify what resources are required to reach the goal, formulate a timeline for when specific tasks need to be completed and determine what resources are required. (Source: <http://whatis.techtarget.com/definition/action-plan>)

Contents of Action plan

The Action Plan should include at least the following items:

- Date
- Action work
- Materials
- Responsible person
- Starting day
- Supporter name

Sample descriptions on Action plan

DISTRICT: Mchinji	TA: Zulu	VILLAGE: A village	BOREHOLE NO: 1
--------------------------	-----------------	---------------------------	-----------------------

Date	Action work	Materials	Responsible person	Starting Day	Supporter name
1 st April 2015	Example Construction of fence a) Type of fence: Timber type b) Volunteer member for construction: Ms. Gama, Mr. Phiri c) Contribution from each household 50MK/Household	Timber Nail Saw Hammer Solignum Labour	Mr. Gondwe Ms. Banda	15 April, 2015	Mr. Chirambo

ACTION PLAN FOR COMMUNITY BASED MANAGEMENT

DISTRICT: Mchinji	TA: Zulu	VILLAGE: A village	BOREHOLE NO: 1
--------------------------	-----------------	---------------------------	-----------------------

Date	Action work	Materials	Responsible person	Starting Day	Supporter name
1 st April 2015	Example Construction of fence a) Type of fence: Timber type b) Volunteer member for construction: Ms. Gama, Mr. Phiri c) Contribution from each household 50MK/Household	Timber Nail Saw Hammer Solignum Labour	Mr. Gondwe Ms. Banda	15 April, 2015	Mr. Chirambo

Module 7: Mainstreaming Crosscutting Issues

Introduction

This module discusses Gender, HIV and AIDS and Environment as cross-cutting issues affecting effective delivery of water and sanitation services. The module will enhance the understanding of these issues and broaden the ability of WPCs to mainstream the issues in the water and sanitation services.

Objectives

By the end of this module, participants should be able to:

1. Demonstrate an understanding in mainstreaming cross cutting issues in water supply and sanitation programmes and activities.

Content

This module contains the following sessions:

Session 1: Gender

Session 2: HIV and AIDS

Session 3: Environment

Session 1: Gender

Introduction

The gender mainstreaming approach considers that society and institutions must change ideas and practices in support of equal choices and opportunities. Thus, the gender mainstreaming practice has become a necessity due to paradigm shift in understanding the problem of inequality between women and men.

This topic aims at equipping participants with knowledge and skills on how to mainstream gender in water supply and sanitation activities. It also looks at the solution to the gender issues and concerns.

Learning Objectives

By the end of this topic, participants will be able to:

1. Define gender
2. Describe gender mainstreaming
3. Identify gender issues and concerns in water and sanitation sector
4. Identify solutions to gender issues and concerns

Content

Definition of Gender

Activity 7.1

Step 1

Facilitator divides participants into buzz groups to define gender.

Step 2

Facilitator consolidates the responses and presents the definition.

Definition

Gender is socially constructed roles and responsibilities assigned to women, men, boys and girls in a given culture or location.

Description of Gender mainstreaming

Activity 7.2

Step 1

In a lecturette the facilitator describes gender mainstreaming.

Description

Gender mainstreaming is the process of integrating gender needs, issues and concerns in all programmes and activities in order to promote equality. It integrates gender concerns in the formulation, implementation and monitoring of policies, programmes, projects, processes, budgets, legal instruments and activities. It also involves changing institutional policies, programmes and processes so that they promote gender equality and not just having equal numbers of women and men.



Figure 21: Man and Women Collecting Water

Gender Issues and Concerns in Water Supply and Sanitation

Activity 7.3

Step 1

Facilitator divides participants into groups to discuss gender issues that impact on water and sanitation activities.

Step 2

Facilitator consolidates responses and presents gender issues and concerns in water and sanitation sector.

Gender Issues and Concerns

- Key decision making positions are dominated by men.
- Low participation of men in water and sanitation activities.
- Responsibility for collection of water rests in the hands of women and girls.
- Most water and sanitation committees are dominated by men
- Lack of gender disaggregated data.



Figure 22: Women voices should also be heard

Solutions to Gender Issues and Concerns

Activity 7.4

Step 1

Facilitator divides participants into groups to discuss solutions to gender issues and concerns.

Step 2

Facilitator consolidates the responses and presents solutions to gender issues.

Solutions

The following are some of the solutions to the gender issues and concerns:

- Encourage women and other disadvantaged groups to participate in decision making. Sensitize and encourage men to participate at all levels of management of water supply and sanitation projects.
- Sensitize communities that the role of collecting water is everyone's responsibility
- Involve women and other disadvantaged groups in the development and management of water supply and sanitation activities.
- Provide women and other disadvantaged groups with opportunities to play leadership roles in community based development of water supply and sanitation.
- Improve situations where women and other disadvantaged groups can easily access water and sanitation facilities.
- Educate women and other disadvantaged groups on water, sanitation and health situations

References

Ministry of Irrigation and Water Development, March 2010, Water Users Association Training Manual

Facilitator's Notes

Areas of emphasis

Gender issues and concerns affecting water supply and sanitation services

Key words

- Gender mainstreaming
- Gender concerns
- Gender issues

Assumed prior knowledge

The topic will build on the local knowledge that the participants have on gender issues such as how to share roles and responsibilities in their communities.

Methodology

- Buzz group
- Lecturette
- Brainstorming
- Group discussion

Resources

Flip charts, A4 photocopying papers, writing pens, masking tape, handouts, file covers, shorthand notebook, LCD projector, audio visual equipment.

Session 2: HIV and AIDS

Introduction

HIV and AIDS mainstreaming is vital in the proper management of water and sanitation activities. This topic discusses the process of mainstreaming HIV and AIDS in Water and sanitation programmes.

Learning Objectives

By the end of this topic, participants will be able to:

1. Define HIV and AIDS
2. Outline the impact of HIV and AIDS in water supply and sanitation activities
3. Explain ways of mainstreaming HIV and AIDS in water supply and sanitation programmes
4. State importance of mainstreaming HIV and AIDS in water supply and sanitation activities

Content

Define HIV and AIDS

Activity 7.5

Step 1

Facilitator asks the participants to brainstorm the definition of HIV and AIDS.

Step 2

Facilitator consolidates responses and presents the definition of HIV and AIDS.

Definition

HIV

Stands for “Human Immune-deficiency Virus”. It is the virus that destroys the human immune (defence) system rendering the body vulnerable to other infections.

AIDS

AIDS is an acronym that stands for Acquired Immune-Deficiency Syndrome. It is not one disease, but a set of diseases. Not all people who develop AIDS suffer from the same disease, but there are certain unusual illnesses that occur very frequently in AIDS. That is why it is called a “Syndrome”. This syndrome is caused by a virus which affects the body’s immune system, making it liable to infections.

Impact of HIV and AIDS in Water Supply and Sanitation

Activity 7.6

Step 1

Facilitator divides participants into groups to discuss the impact of HIV and AIDS in water supply and sanitation activities.

Step 2

Facilitator consolidates the responses and presents some of the impacts.

Impacts

- Indigenous knowledge in water and other natural resource management is lost leading to inappropriate ways of utilisation.
- Households sink into poverty and this leads to over-exploitation of the natural resources including water resources.
- Caring for the sick limits women's participation in water and sanitation activities.
- Expenses for the sick impede household abilities to pay for water and sanitation services.
- Social cohesion is weakened and traditional participatory channels become dysfunctional.
- Perceived affected and infected face stigma and discrimination leading to a loss of self-esteem.
- Institutions that are important for the management of water resources at community and higher levels are losing capacity at a fast rate.

Ways of Mainstreaming HIV and AIDS**Activity 7.7****Step 1**

Facilitator divides participants into small groups to discuss ways of mainstreaming HIV and AIDS in water supply and sanitation programmes

Step 2

Facilitator consolidates the responses and presents ways of mainstreaming HIV and AIDS.

Ways

- Use of HIV and AIDS focal points.
- Use of training in various skills.
- Building structures for enabling high-level support.
- Use of research and impact/predictive studies.
- Establishment of HTC Centres.



Figure 23: HTC Centre

Importance of mainstreaming HIV and AIDS**Activity 7.8****Step 1**

Facilitator asks participants to buzz in groups the importance of mainstreaming HIV and AIDS in water and sanitation activities.

Step 2

Facilitator consolidates the responses and presents the importance of mainstreaming HIV and AIDS in water and sanitation activities.

Importance

- Improve and sustain knowledge in water and sanitation management.
- Sustenance of natural resources including water resources.
- Increased women's participation in water and sanitation activities.
- Improved ability to pay for water and sanitation services.
- Social cohesion will be strengthened and traditional participatory channels will be functional.
- Reduced stigma and discrimination leading to enhanced self-esteem.

References

Ministry of Irrigation and Water Development, March 2010, Water Users Association Training Manual

Facilitator's notes

- Definition of HIV and AIDS
- Impact of HIV and AIDS in water and sanitation
- Ways of mainstreaming HIV and AIDS,
- Importance of mainstreaming HIV and AIDS in water and sanitation.

Key words

HIV, AIDS, impact, importance, mainstreaming.

Assumed prior knowledge

Participants are aware of the modes of transmission, ways of caring and supporting the affected and the infected as discussed in topic one.

Methodology

- Buzz group
- Brainstorming
- Group discussion

Resources

Flip charts, A4 photocopying papers, writing pens, masking tape, handouts, file covers, shorthand notebook, LCD projector, audio visual equipment.

Session 3: Environment

Introduction

Environment is key to sustenance of the availability and quality of water resources. However, environmental degradation is rampant in many parts of the country affecting the water resource including piped water supply systems. Any source of water has its own catchment area which needs protection.

This topic aims at equipping participants with knowledge and skills on how to protect respective catchment areas effectively.

Learning Objectives

By the end of this topic, participants will be able to:

1. Define catchment area
2. State the importance of catchment area
3. Describe factors that affect the quantity and quality of water from the catchment area
4. State malpractices that affect catchment areas
5. Describe the effects of a poorly managed catchment area
6. Explain the common methods of conserving, managing and improving catchment areas

Content

Definition of Catchment area

Activity 7.9

Step 1

Facilitator asks participants to buzz in groups the definition of catchment area.

Step 2

Facilitator consolidates the responses and defines catchment area.

Definition

A catchment area is an entire area from which raw water drains into water bodies.

Importance of catchment

Activity 7.10

Step 1

Facilitator asks participants to brainstorm the importance of catchment area.

Step 2

Facilitator consolidates the responses and presents the importance of catchment area.

Importance

Catchment area provides water for the following uses:

- Drinking
- Washing
- Agriculture/irrigation
- Industry
- Recreation
- Wildlife – with food and shelter
- Hydro-power as well as water transport

Factors that affect quantity and quality of water from catchment areas

Activity 7.11

Step 1

Facilitator asks participants to buzz in groups the factors that affect quantity and quality of water from catchment areas.

Step 2

Facilitator consolidates the responses and presents the factors that affect quantity and quality of water from catchment areas.

Factors

- Size of the catchment area.
- Amount of rainfall.
- Amount of water lost through evaporation.
- Gradient (slope) of the land.
- Amount of surface runoff.
- Soil type.
- Vegetation.
- Land use – Farming, forestry, buildings (houses and other structures).

Malpractices that affect catchment areas

Activity 7.12

Step 1

Facilitator divides participants into groups to discuss the malpractices that affect catchment areas.

Step 2

Facilitator consolidates the responses and provides the malpractices that affect catchment areas.

Malpractices

- Deforestation – Removes vegetative cover leading to erosion, gullies, etc.
- Poor agricultural practices – No contour and box ridges, ridges along slopes, too close to river banks lead to erosion and siltation of reservoir.
- Pollution – Fertilizer use close to reservoir, toilets upstream of reservoir, poor waste management, effluent disposal leading to infected and dirty water.
- Encroachment – makeshift homes, school, etc. boundaries into the catchment.
- Illegal developments.
- Wild bush fires.

The effects of a poorly managed catchment area and proper methods of conservation

Activity 7.13

Step 1

Facilitator divides participants into groups to discuss the effects of poorly managed catchment areas and common methods for conserving, managing and improving catchment areas.

Step 2

Facilitator consolidates the responses and presents the effects of poorly managed catchment areas and common methods for conserving managing and improving catchment areas.

Effects and Common Methods

Effects	Common Methods
<ul style="list-style-type: none"> • Bare lands on the catchment • Silted up and dry rivers • Reduced water amounts in reservoirs • Vegetation growth within the reservoirs <p>All these result in water supply shortages and poor quality water</p>	<ul style="list-style-type: none"> • Afforestation Trees in bare lands, along rivers, around homesteads • Proper agricultural practices such as Ridges across slopes, following contours, box ridges, planting vertiver grass, use of manure, observing buffer zones, etc. • Good sanitation practices • Monitoring and control <ul style="list-style-type: none"> - Form or use existing village level catchment management committees or form a catchment management committee under the WUA. - Get trained and come up with control regulations/By-laws.

Effects	Common Methods
	<ul style="list-style-type: none">- Use existing local structures like local leaders, ADCs, VDCs.• Community Policing

References

Ministry of Irrigation and Water Development, March 2010, Water Users Association Training Manual

Facilitator's Notes

Areas of emphasis

- Definition of catchment area
- Effects of catchment area degradation
- Common methods of conserving, managing and improving catchment area

Key words

Catchment, conservation, degradation

Methodology

- Brainstorming
- Group discussion
- Buzz group

Resources

Flip charts, A4 photocopying papers, marker pens, masking tape, handouts, file covers, shorthand note book, LCD projector, audio visual equipment.

Additional information

Water within a Catchment

How water gets formed and move within our catchment

- Rain falls on bare grounds and runs off and drains into small streams which eventually join a river, lake.
- Some of the rain water infiltrates into the ground.
- Water that exists underground sometimes comes out to the ground to form rivers.
- Generally water flows to lowest parts of the catchments, whether surface or underground water i.e. the water flows to rivers and lakes.
- Flowing back of water to rivers, lakes recharges the volumes of the existing water bodies.

Module 8: Community Mobilization

Introduction

Whoever starts the action to improve water, sanitation and health – the whole community must be involved as soon as possible. Without the community participation right from the beginning and all the way through, the program will simply not work.

Community in this context might involve the whole village or part of the village that uses a specific water point. In other words, the “user community” or “beneficiaries” of the water point.

This module will enable participants to involve the community in decision making required for the proper operation and maintenance of water points.

Objectives

By the end of the module, participants should be able to:

1. Plan a meeting to involve all user communities/beneficiaries
2. Develop the agenda of the meeting
3. Facilitate the process of decision making through participation of the whole community
4. Finalize the FMP and Action Plan

Content

The module covers the following sessions:

Session 1: Organizing the first meeting with the beneficiaries

Session 2: Providing regular support to WPCs/VHWCs

Session 1: Organizing the first meeting with the beneficiaries

Introduction

This session will equip participants on how to mobilize the community in order to promote regular payment of water tariff, water point sanitation and hygiene by all beneficiaries and agree on the following issues:

- Decide the amount that every household will be paying for O&M purposes (cash and/or in-kind)
- Frequency of payment
- Water tariff collection method and responsible person
- Accountability in the management of water funds
- Appoint responsible person/group in charge of cleaning the borehole surrounding
- Decide frequency of cleaning
- Agree on rules and penalties in case of non-compliance in the payment of water tariffs and cleaning of borehole surroundings
- Safety and security measures for water points to curb vandalism of water points

Learning Objectives

By the end of this session, participants should be able to:

1. Agree on the best way of involving the whole community
2. Prepare an agenda for organizing a village meeting
3. Decide on the date and time for conducting the village meeting

Tool Kit

Tool 20: WPC Meeting Agenda and Checklist

Content

Community mobilization – organizing the first meeting

Activity 8.1

Step 1

Decide who will facilitate the village meeting, i.e., the village headman, influential person and members of the WPC/VHWC

Step 2

Discuss other supporters that could be called for the village meeting

In the village: music bands/choirs, Area Mechanic

From the government: Extension workers (HSA, CDA, and WMA)

Step 3

Discuss about appropriate date and time for conducting the village meeting in order to ensure participation of all water point beneficiaries

Step 4

Draft an agenda of the meeting and a check list on issues to be discussed and decided with all beneficiaries. Make sure that promotion songs and village head consensus forms are used as effective tools for community mobilization.

During the training of WPCs/VHWCs

- The EWs should be able to explain the Village Head’s consensus forms: i) for regular payment of water tariff and, ii) form for promotion of water point sanitation.
- The EW should be able to receive the village head, influential person and the chair of the WPC/VHWC commitment for the promotion of regular payment of water tariff and water point sanitation and subsequently obtain their signatures.
- The EWs should collect the signed consensus form and laminate it (if possible) and return the forms to the WPC during the second day of the training. The signed consensus forms will be used during the meeting with beneficiaries.

Recommended steps to be followed for organizing the village meeting

- The EWs to present the signed (and laminated) “village head consensus form for regular payment of water tariff” to the village head man.
- The village headman to declare his/her commitment in the promotion of regular payment of water fee and water point sanitation.
- The EWs to declare and commit to provide technical support and monitoring on behalf of the Government of Malawi
- The village head man, EWs, the members of the WPC/VHWC, influential person, area mechanics and any other performance group/choir to play and sing the promotion song “Water is Life” and “We should not underrate”. Practice the song with the whole village. It is highly recommended that the villagers sing the promotion songs in their own traditional tunes to increase ownership and responsibility of the whole community towards their borehole.
- The EWs to support discussions to involve the whole community in decision-making. Decision made during this village meeting will be use to review the Facility Management Plan as well as for the development of the Action Plan.

Some key issues to discuss and decide are listed below; however, it is recommended that the Facility Management Plan and the Action Plan are filled by the Secretary of the WPC during the village meeting.

- Water point beneficiaries/users responsibilities (i.e., agree that all households should contribute water tariff cash or in-kind, cleaning the water point surrounding, support in the construction of sanitation facilities, etc)
- Amount of water tariff per household taking into consideration flexible arrangements for vulnerable/low-income households
- Method of payment (cash or in-kind)
- Frequency of payment of water tariffs
- Payday
- Method of fee collection (visiting each house, at the water point, etc.)
- How to keep water tariffs (at the bank, with the WPC Treasure, procuring easy worn spare parts instead of cash, etc.)

- Rules and penalties for non-compliance of water tariff payment
- Relocation of sources of pollution (such as latrines, refuse pits, animal cages, bath shelters, cultivations, grave yard, etc) that are located at less than 30m from the head of the hand pump (in case of deep well, Afridev pump) or less than 100m (in case of shallow well, Malda pumps).
- Preparation of cleaning roster which includes information on: i) name of responsible person/group, ii) frequency of cleaning activities (i.e., daily mopping and sweeping, weekly cleaning of soak away pits, etc.), iii) penalties for non-compliance in maintaining a clean borehole surrounding.
- Repair concrete structures such as cracks and potholes to avoid pooling of stagnant water.
- Decide on the type of fence and soak away pit to be constructed and/or repaired.
- The need of having a contract with an Area Mechanics and the type of contract (preventive and break downs)
- Spare parts procurement plan (fast wearing spares parts that needs to be stocked by the WPCs)

Session 2: Providing regular support to WPCs/VHWCs through Monitoring and Evaluation

Introduction

After the village meeting has been organized as per session 1 of this module, it is important that the EWs conduct regular follow-ups with the villagers to see whether the training exercise has been understood by the WPCs/VHWCs, make sure that village meetings are regularly taking place to discuss relevant issues regarding the water facilities, check the content of the FMP and Action Plan developed during the village meetings, provide support in the use of promotion tools and provide clarification and technical support required by the community.

Learning Objectives

By the end of this session, participants should be able to:

1. Finalise their Action Plans for Community Based Management and FMP
2. Advise the WPC/VHWC on how to use the promotion tools to keep motivating villagers to pay water tariffs in achieving activities decided during the village meeting
3. Provide continuous support to the villages in their catchment area through regular M&E

Content

Feedback from the village meeting

Activity 8.2

Step 1

Facilitator asks participants to explain the outcomes of the village meeting

Step 2

Facilitator check the Action Plans and the Facility Management Plan to see whether all topics were covered during the village meeting

Step 3

Facilitator provide feedback on contents that still needs to be covered (if any) and clarifies any issues that are brought by the participants

Developing the village's own promotion songs, dramas and/or poems

Activity 8.3

Step 1

Facilitator explains the importance of creating the village's own song in their traditional tune as well as drama and/or poem that are easier to understand for the WPC/VHWC to pass on the information to their fellow villagers in order to engage the whole community

Step 2

Facilitator encourages participants to develop their own promotion song in their village traditional tune so that it becomes their own song. If possible also ask to prepare drama and or poem so that the message reaches the villagers in a fun and attractive way and as a result, increase community ownership and responsibility towards water facilities.

Facilitator consolidates responses.

For this activity, the EWs can use the radio cassette/CD with sample traditional songs, drama and poems from the different pilot villages in Mchinji District to appreciate what other WPCs/VHWCs have developed.

The promotion songs and Village Head's consensus form could be used in meetings and gatherings in the village to pass on the message. Occasions for singing the song are: at the borehole, places where people meet for parties, sports, when conducting development work such as moulding the bricks, during village bank meetings, etc.

In the same way, the Village Head's Consensus Form could be displayed in places where it is visible to the water point beneficiaries such as in a tree near the borehole, at the Village Head's house.

The EWs need to continue following up with the Village Headman, WPC/VHWCs members and influential person in the village and provide the required technical support to see whether the villagers are constantly paying their water tariffs, maintaining a clean borehole surrounding, conducting regular maintenance, etc. to make sure that everybody have continued access to safe water by reducing the hand pump down time due to timely repair of hand pumps.

Module 9: Monitoring & Evaluation

Introduction

This module aims at imparting knowledge and skills on Monitoring and Evaluation (M&E) to enable members of Water Point Committee (WPC) understand how Afridev handpumps are operated and maintained to ensure sustainability and access to potable water supplies.

The module introduces participants to importance of M&E. It will assist WPC members in proper management of water supply facility.

Objectives

By the end of this module, participants should be able to:

1. Conduct monitoring and evaluation
2. Describe key points of monitoring and evaluation

Content

This session contains the following topics:

Session 1: What is monitoring and evaluation?

Session 2: How to carry out monitoring and evaluation

Session 1: What is Monitoring and Evaluation?

Introduction

Monitoring and Evaluation are important for management and improvement of projects as well as existing services. Knowing and understanding the progress and status of projects and/or activities in the management cycle is essential for its effectiveness and completion. Periodic information on facility management is required so that proper action is taken. It is necessary to follow a proper sequence for the planning and implementation of successful O&M activities in a Community Action Cycle.

Monitoring is a continuous processes and it is an on-going activity and provides a continuous picture as to whether or not projects or services are proceeding or functioning according to the plan.

Evaluation is carried out at intervals either in response to a problem or when a project phase or period is completed. Monitoring is an internal activity, whereas evaluation may be carried out also externally or in a combination. It is necessary to review the process and status of implementation. This ultimately aims at reviewing the activities on O&M at community level.

Monitoring and evaluation data are not to be used as a tool for criticising communities and/or EWs. This actually may result in people not collecting reliable information in future. Instead, the focus should be on learning, and on adapting and improving procedures, activities and results.

Learning Objectives

By the end of this session, participants should be able to describe the outline of the monitoring and evaluation

Content

What is monitoring and evaluation?

Activity 9.1

Step 1

The facilitator divides participants into groups to discuss how communities can take part in monitoring and evaluation.

Step 2

The facilitator consolidates the responses and presents areas in which communities can take part.

Objective of the Monitoring

Monitoring is a regular check-up to see progress of activities in the management cycle and to see if the communities are achieving their goals or results.

It provides data on the progress of each activity – what has been done and what has not been done – and identifies problems and their causes. This data helps communities and EWs to make decisions to improve various activities.

Objective of the Evaluation

Evaluation is to assess the impact of the implementations / activities during and/or end of the cycle on O&M.

References

Ministry of Water Development, 1999, Trainer's Guide for Extension Worker Training
Ministry of Water Development, 1999, Trainer's Guide for WPC/VHWC Training

Session 2: How to carry out monitoring and evaluation

Introduction

As tools to support and improve the performance on O&M activities, monitoring and evaluation should be done in partnership with communities. Women, men and village leaders should participate in information collection and analysis. The WPC will spearhead monitoring at community level with support from health surveillance assistants (HSAs) and/or senior health surveillance assistants (SHSAs).

Learning Objectives

By the end of this session, participants should be able to:

1. Describe key indicators on O&M to be tracked by the communities
2. Describe key indicators on O&M to be tracked by the extension workers (EWs)

Tool Kit

Tool 21: Monitoring Form

Content

How to carry out M&E

Activity 9.2

Step 1

The facilitator divides participants into groups to brainstorm about indicator and also three major goals and results such as 1) community management, 2) sustainable water supply, 3) improved hygiene.

Step 2

The facilitator consolidates the discussions and presents key indicators for above points.

Indicators to be tracked by the communities

Monitoring indicators are required to measure or point out progress impacts and effects. These indicators should be based on the specific objectives. Some of them are as follows:

Community Management	Sustainable Water Supply	Improved Hygiene
➤ WPC elected by community	➤ Water fee contributions	➤ Using water point regularly
➤ Accountable to community	➤ Spare parts and tools	➤ No longer using old facility
➤ 50% of WPC members are women	➤ Inspection & maintenance (weekly, monthly)	➤ Washing hands with soap
➤ Number of WPC meetings	➤ Quick pump repair	➤ Cleaning of water point site
➤ Amount of O&M funds	➤ Records of breakdowns	
➤ Record keeping (user		

Community Management	Sustainable Water Supply	Improved Hygiene
contribution book, cash book)		

Indicators to be tracked by the EWs

One of the EWs' tasks is to make regular visits to check on how the WPC is doing, to assist the WPC with problem solving, and monitor their activities.

The monitoring indicators by the EWs should include at least the following components:

- Did the WPC have a meeting with users about water tariff setting after the training?
- Was a water tariff set up?
- How much is the water tariff per household? And at what frequency is it collected?
- Number of households that paid the water tariff?
- Total amount of fee collected so far
- For what purpose is the water tariff collected?
- Are you using the user's contribution book to record the beneficiaries who paid for water?
- What penalty has been agreed on beneficiaries who fail to contribute water tariff for O&M?
- Are you using the cash book when procuring spare parts and received water tariffs from beneficiaries?
- Progress observed in the fence
- Progress observed in the soak away pit
- Is the borehole surrounding being cleaned as per the cleaning roster?
- Are you stocking hand pump spare parts and maintenance tools?
- Are the caretakers conducting preventive maintenance?
- Do you think the Village Head Consensus forms have helped in promoting regular payment for water and water point sanitation?
- Did you play the promotion songs during the village meetings?
- When and where is the Village Head Consensus form used or displayed?

Key points

Given the large number of villages to be covered and the long distance involved, follow-up work should be divided among extension workers. A team of EWs (WMAs, CDAs, HSAs), should be assigned a number of villages to visit on a regular basis.

However, WMAs and CDAs are mostly facing transportation, human resources and budgetary constraints so that HSAs and SHSAs have a potential to work on regular monitoring for the communities.

Additionally, the monitoring of WPCs by EWT has **proven to raise the motivation for regular maintenance of water facilities by the community.**

Feedback

To ensure that communities are involved in monitoring, a mechanism should be put in place for their involvement in some analysis of data. After data analysis feedback should be given to the communities.

References

Ministry of Water Development, 1999, Trainer's Guide for Extension Worker Training

Ministry of Water Development, 1999, Trainer's Guide for WPC/VHWC Training

APPENDICES

1. LIST OF PARTICIPANTS IN THE MANUAL PRODUCTION

Mr. S. Maweru	Principal Secretary	MoAIWD
Mr. S. Mwanza	Director of Water Supplies Services	MoAIWD
Ms. E. Mbalame	Deputy Director Water Supplies Services	MoAIWD
Mr. J. Kumwenda	Economist, Planning Department	MoAIWD
Mrs. J. Banda	Senior Assistant Water Resources Officer	MoAIWD
Mr. S. Kautsi	Civil Engineer, Sanitation Department	MoAIWD
Mr. T. Sitolo	Principal Community Water Supply Officer	MoAIWD
Mr. G. Matiki	Principal Hydrogeologist	MoAIWD
Mr. R. Chiwaula	Senior Drilling Officer	MoAIWD
Mr. P. Chipeta	Regional Water Development and Irrigation Officer (Centre)	RWDIO (C)
Mr. S. Mashunga	Senior Community Water Supply Sanitation Officer	RWDIO (C)
Mr. M. Chilimadzi	District Water Development Officer	Mchinji DWDO
Mr. M. Membe	Water Monitoring Assistant	Mchinji DWDO
Mr. M. Kachala	Water Monitoring Assistant	Mchinji DWDO
Mr. T. Mchipha	Deputy District Environmental Health Officer	Mchinji DEHO
Mrs. J. Mtukuso	District Community Development Officer	Mchinji DCDO
Mr. D. Semu	Health Promotion Officer	Mchinji DEHO
Mr. W. Chikuni	Director of Planning and Development	Mchinji District Council
Mr. P.K. Chambeu	Monitoring and Evaluation Officer	Mchinji District Council
Mr. P. Moyo	District Water Development Officer	Ntchisi DWDO
Mr. A. Dembo	District Environmental Health Officer	Ntchisi DEHO
Mrs. E. C. Jana	District Community Development Officer	Ntchisi DCDO
Mr. M. Chimkhuzi	District Environmental Health Officer	Salima DEHO
Mr. B. Chanachi	District Community Development Officer	Salima DCDO
Mr. W. Chungwa	District Water Development Officer	Salima DWDO
Mr. M. Nhlema	Communication and Monitoring Specialist	Water for People
Mr. F. Banda	WASH Coordinator	Concern Universal
Mr. U. Gondwe	Programme Officer	WaterAid
Mr. A. Njeresu	Water Supply Specialist	InterAide
Mr. J. Mankhokwe	Maintenance supervisor	InterAide Mchinji
Mr. F. Hers	Project Officer	InterAide
Mr. C. Olivier	Area Manager	InterAide
Mr. C. Chiumia	Field Coordinator	Plan International
Mr. Y. Une	JICA Expert	JICA O&M Project
Mr. T. Yoshikawa	JICA Expert	JICA O&M Project
Ms. N. Yamada	JICA Expert	JICA O&M Project
Mr. H. Namwiri	JICA Assistant	JICA O&M Project
Mr. W. Lakudzala	JICA Assistant	JICA O&M Project

2. PREPARATION OF THE TRAINING FOR WPCs

2.1 Expected target trainees

No	Position
1	Group Village Head
2	Village Head
3	Influential person
4	Chair of WPC (1)
5	A member of WPC/VHWC (2)
6	A member of WPC/VHWC (3)
7	A member of WPC/VHWC (4)
8	A member of WPC/VHWC (5)
9	A member of WPC/VHWC (6)
10	A member of WPC/VHWC (7)
11	A member of WPC/VHWC (8)
12	A member of WPC/VHWC (9)
13	A member of WPC/VHWC (10)

2.2 Distribution materials to WPC member

No	Item	Qty	Picture
1	Notebook for cash book and user contribution book	1	
2	CD or tape for promotion songs	1	
3	CBM O&M Refresher Tool Kit	1	
4	Calendar for trouble shooting	1	
5	Village head consensus form for promotion of regular payment of water fee with laminate	2	
6	Village head consensus form for promotion of regular payment of water fee with laminate	2	
7	Pen and paper for WPC members	5	

2.3 Distribution materials to WPC member

No	Item	Qty	Picture
1	Flip chart	1	
2	Flip chart stand	1	
3	Masking tape	1	
4	Marker pen	1	
5	Radio cassette recorder	1	
6	Laminating machine	1	
7	Laminate film	1	
8	Spare parts for Afridev handpump	1	



Rural Water Supply Operation and Maintenance Series were developed for planners, managers and practitioners for the practices of operation and maintenance of boreholes fitted with Afridev hand pumps in rural Malawi.